

Crane
weddings

2023



Crane



AVIGNON FRENCH FOLD SUITE

PAPER CODE	DESCRIPTION	WEIGHT	PRICE GROUP
LN1116	NOTE	32#	V
LE1116	NOTE ENVELOPE	32#	V
LC3116	ANNOUNCEMENT CARD (shown 2 color)	96#	R
LE3116	ANNOUNCEMENT ENVELOPE (not shown)	32#	R

DESIGN ELEMENTS

Lettering	LONDON SCRIPT
Monogram	MON206A (on note) MON206B (on announcement)
Inks	GOLD CHARCOAL
Process	ENGRAVING
Lining	LIN443E Metallic Gold (additional - price group HH)
Paper	ECRU KID FINISH®

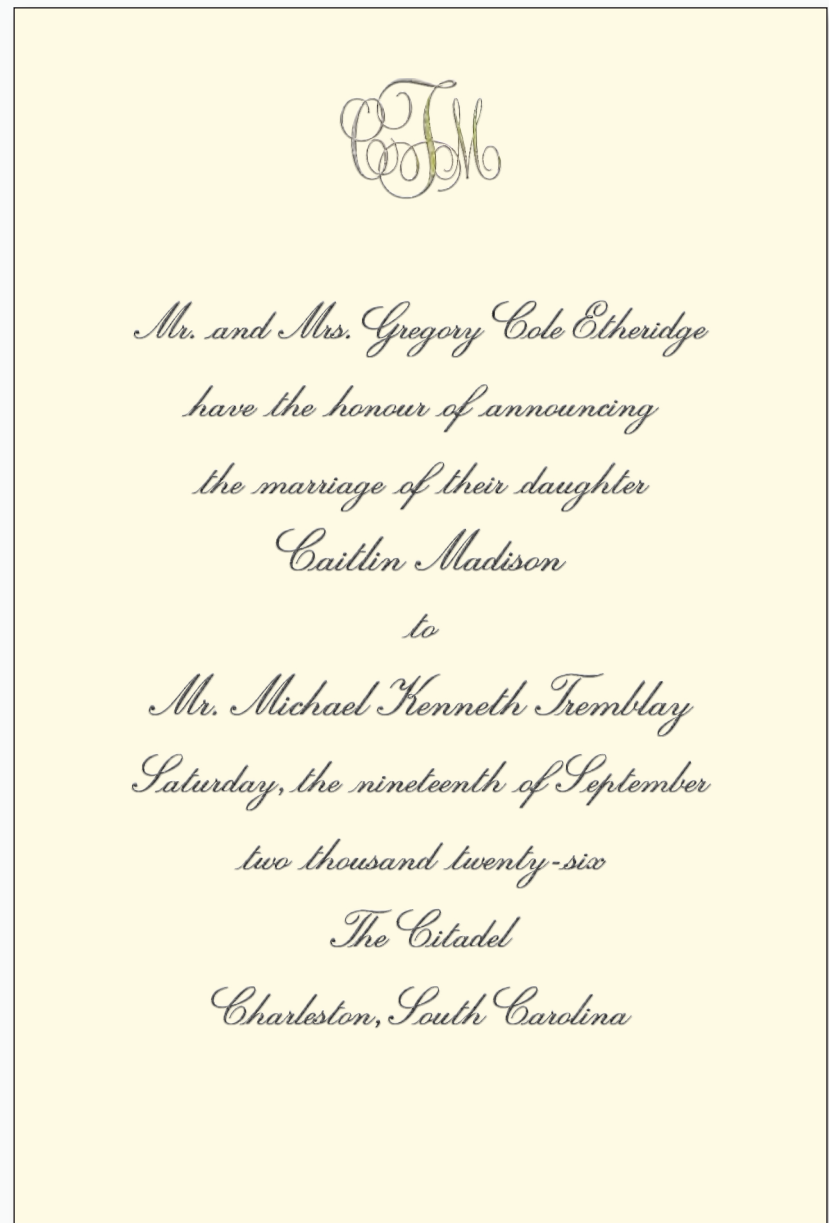

AVIGNON FRENCH FOLD SUITE

PAPER CODE	DESCRIPTION	WEIGHT	PRICE GROUP
LC3116	REHEARSAL DINNER CARD	96#	R
LE3116	REHEARSAL DINNER ENVELOPE (not shown)	32#	R
T84-124	PLACE CARD	64#	EE
LC1116	ACCOMMODATION CARD	96#	AA

DESIGN ELEMENTS

Lettering	LONDON SCRIPT
Monogram	MON206B
Motif	MOT1402A Loopy Swash
Inks	CHARCOAL GOLD
Process	ENGRAVING
Paper	ECRU KID FINISH®

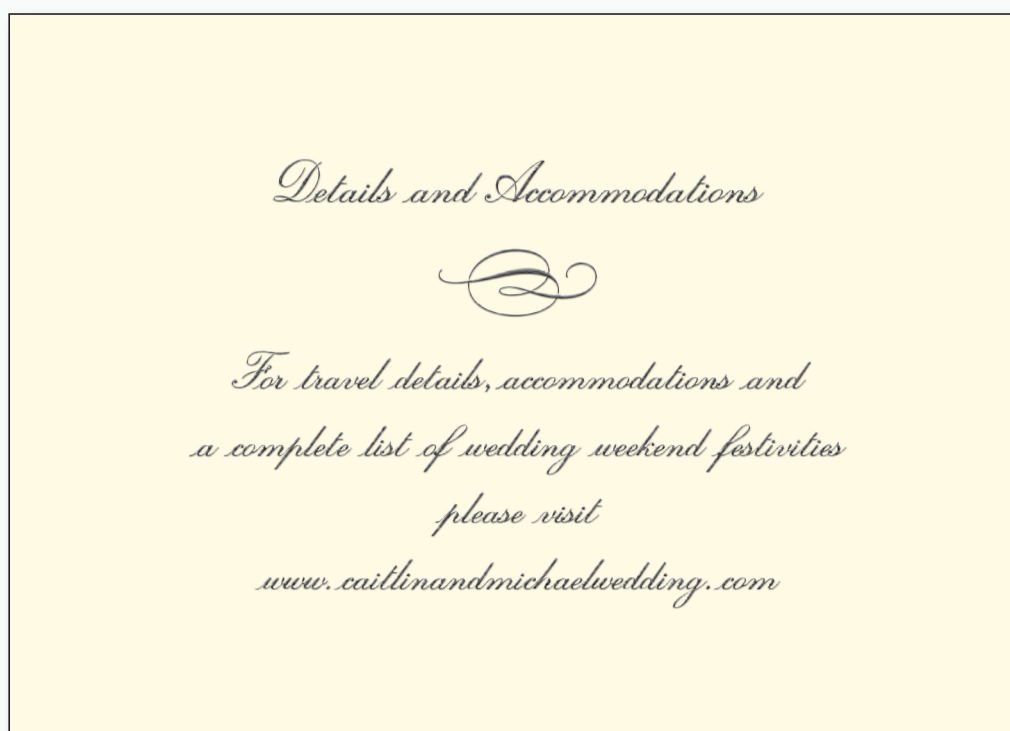
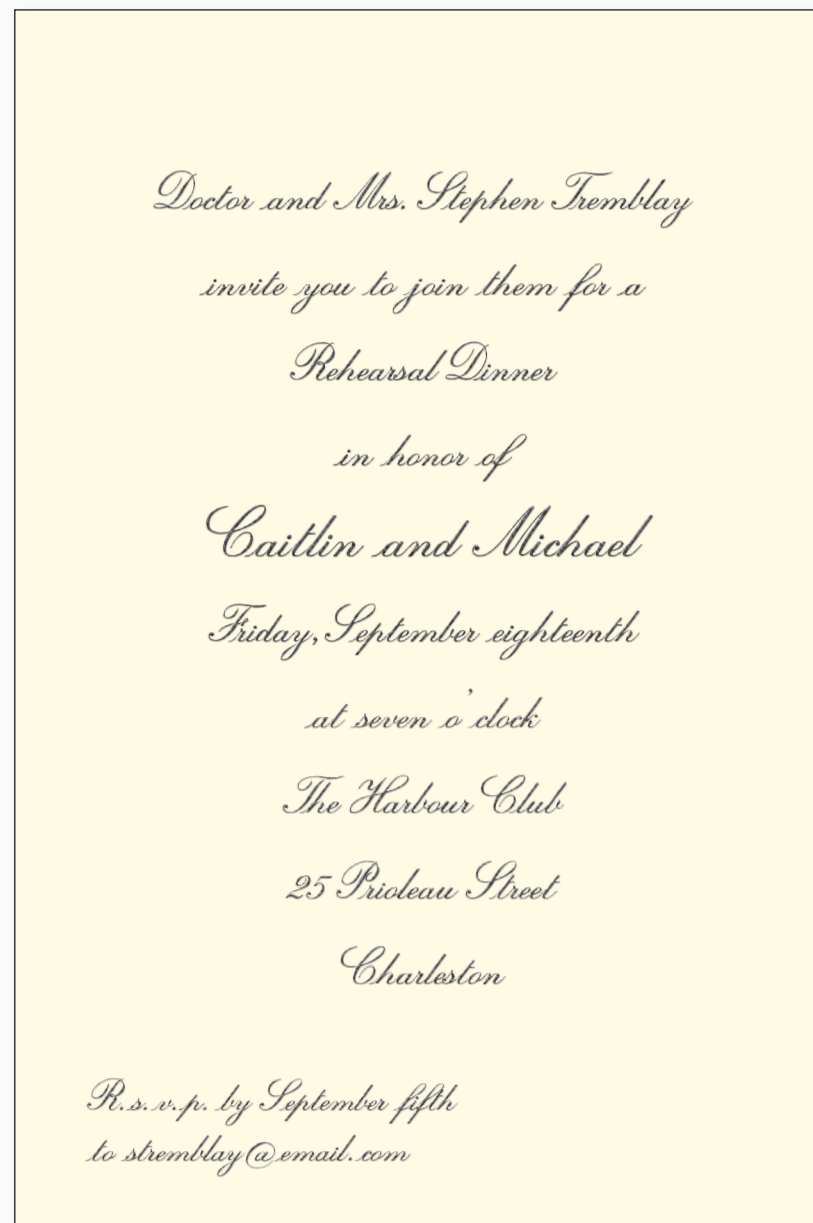

Within the Ribbon



*Please present this card at
Summerall Chapel*

*Reception
immediately following the ceremony*

The William Aiken House

*456 King Street
Charleston*

*Mr. and Mrs. Gregory Etheridge
Twelve Oaks Drive
Charleston, South Carolina 29414*



*The favour of a reply is requested
before the twenty-eighth of August*

AVIGNON FRENCH FOLD SUITE

PAPER CODE	DESCRIPTION	WEIGHT	PRICE GROUP
V31-130	WITHIN THE RIBBON CARD	96#	EE
LC1116	RECEPTION CARD	96#	E
LC1116	RESPONSE CARD (shown 2 color)	96#	E
LE1116	RESPONSE ENVELOPE	32#	E

DESIGN ELEMENTS

Lettering	LONDON SCRIPT
Monogram	MON206B
Motif	MOT1402A Loopy Swash
Inks	CHARCOAL GOLD
Process	ENGRAVING
Paper	ECRU KID FINISH®

*Twelve Oaks Drive
Charleston, South Carolina 29414*



*Mr. and Mrs. Gregory Cole Etheridge
request the honour of your presence
at the marriage of their daughter
Caitlin Madison
to
Michael Kenneth Tremblay
Saturday, the nineteenth of September
two thousand twenty-six
at half after five o'clock
Summerall Chapel
The Citadel
Charleston, South Carolina*

Black tie

PLEASE NOTE:

- French Fold invitations are available engraved only and may require additional postage.

AVIGNON FRENCH FOLD SUITE • PRICE GROUP E

PAPER CODE	DESCRIPTION	WEIGHT
W88	EMBASSY FRENCH FOLD WEDDING SHEET (shown 2 color)	40#
W65	INSIDE ENVELOPE (ungummed)	32#
W85	OUTSIDE ENVELOPE	32#
LE9116	SINGLE ENVELOPE (not shown)	32#

DESIGN ELEMENTS

Lettering	LONDON SCRIPT
Monogram	MON206B
Inks	GOLD CHARCOAL
Process	ENGRAVING
Lining	LIN443E Metallic Gold (additional - price group HH)
Paper	ECRU KID FINISH®

W-2023



THE FAVOR OF A REPLY IS REQUESTED
BY THE THIRTIETH OF MARCH

M _____

WILL _____ ATTEND

Ellen June Petersen

1812 CALVERT STREET
WASHINGTON, D.C. 20006



Valet Parking

THE FOUR SEASONS HOTEL
WASHINGTON DC



Ellen and David Jennings



BLOSSOMS SUITE

PAPER CODE	DESCRIPTION	WEIGHT	PRICE GROUP
LC1112	LIGHT GRAY RESPONSE CARD (shown 2 color)	110C	A
LE1112	LIGHT GRAY RESPONSE ENVELOPE	32W	A
V12-130	LIGHT GRAY VALET PARKING CARD (shown 2 color)	110C	EE
LF1112	LIGHT GRAY HEAVYWEIGHT NOTE (shown 2 color)	90C	W
LE1112	LIGHT GRAY NOTE ENVELOPE	32W	W

DESIGN ELEMENTS

Lettering	CORONET (block), LA FIGURA (script)
Motifs	MOT706B Branch Small (on reply card), MOT707A Flower
Inks	TAUPE PEONY
Process	ENGRAVING
Lining	LIN1077B Blossom (additional - price group HH)
Paper	LIGHT GRAY LETTRA IMPRESS



1812 CALVERT STREET
WASHINGTON, D.C. 20006



TOGETHER WITH THEIR FAMILIES

Ellen Jane Petersen

AND

David Matthew Jennings

REQUEST THE HONOR OF YOUR PRESENCE

AT THEIR MARRIAGE

SUNDAY, THE TWELFTH OF APRIL

TWO THOUSAND TWENTY-SIX

FOUR O'CLOCK IN THE AFTERNOON

THE FOUR SEASONS HOTEL

WASHINGTON, D.C.



PLEASE NOTE:

- Embassy invitations may require additional postage.
- Double Envelopes are not available for colored papers.



OUR DEAREST FAMILY AND FRIENDS,
 WE ARE SO THRILLED THAT YOU
 ARE WITH US THIS WEEKEND TO SHARE
 A VERY SPECIAL TIME IN OUR LIVES.
 WE HOPE YOU WILL ENJOY ALL THE AMENITIES
 OF THE HOTEL WITH OUR COMPLIMENTS.

MUCH LOVE,

Ellie and Dave

BLOSSOMS SUITE • PRICE GROUP A

PAPER CODE	DESCRIPTION	WEIGHT
LC9112	EMBASSY LIGHT GRAY INVITATION (shown 2 color)	110C
LE9112	LIGHT GRAY SINGLE ENVELOPE	32W
LC1112	LIGHT GRAY ACCOMMODATIONS CARD (shown 2 color)	110C

DESIGN ELEMENTS

Lettering	CORONET (block), LA FIGURA (script)
Motifs	MOT706A Branch (on invitation), MOT707A Flower
Inks	TAUPE PEONY
Process	ENGRAVING
Paper	LIGHT GRAY LETTRA IMPRESS

Response

KINDLY RESPOND BY
THE TWENTY-THIRD OF JULY

M _____

ACCEPTS WITH PLEASURE

PLEASE INDICATE THE NUMBER
OF GUESTS ATTENDING

_____ WELCOME LIBATIONS

_____ FAREWELL BRUNCH

DECLINES WITH REGRET

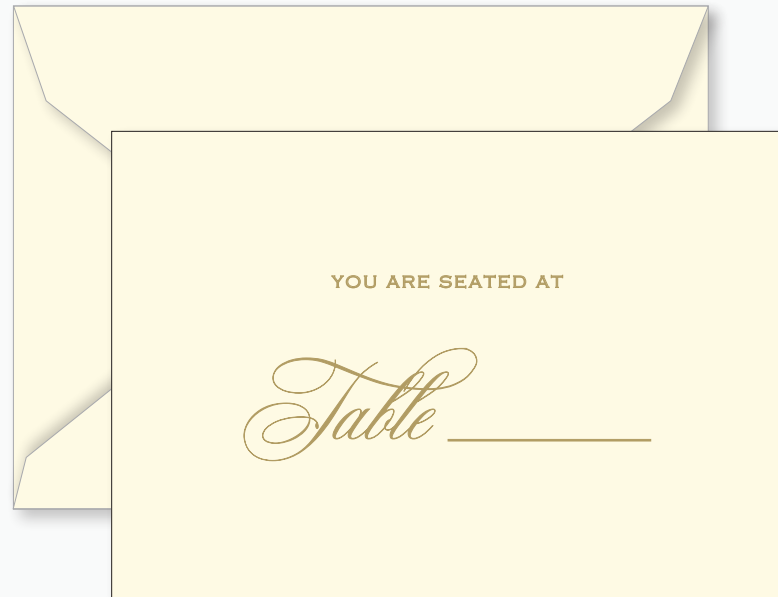

DARCY SUITE

PAPER CODE	DESCRIPTION	WEIGHT	PRICE GROUP
LC1116	RESPONSE/RECEPTION CARD	96#	A
LE1116	RESPONSE ENVELOPE (not shown)	32#	A
V31-130	TABLE CARD	96#	EE
E82-130	TABLE CARD ENVELOPE	32#	EE
LC1116	EVENT CARD	96#	AA

DESIGN ELEMENTS

Lettering	COPPERPLATE LIGHT CAP (block, shown all small caps) MOZART (script)
Motifs	MOT1467A Response MOT1090B Square MOT1468A Table MOT1469A Join Us
Ink	GOLD
Process	THERMOGRAPHY
Paper	ECRU KID FINISH®

PLEASE NOTE:

- See Motif Chart for alternate word motifs

Join us

Friday, August 14th

WELCOME LIBATIONS

HOSTED BY MARY AND TED CONNOLLY

9:00 PM - 11:00 PM

THE SILVER SPOON

Sunday, August 16th

FAREWELL BRUNCH

10:00 AM - 12:00 PM

ROCHESTER BRUNCH HOUSE

FOR ADDITIONAL DETAILS

PLEASE VISIT OUR WEBSITE

AMANDAANDTYLER.COM

Twenty-five Camelot Way
 ROCHESTER, MICHIGAN
48306

Amanda
and
Tyler

MR. AND MRS. PAUL JASON BRENNER
 REQUEST THE PLEASURE OF YOUR COMPANY
 AT THE MARRIAGE OF THEIR DAUGHTER

AMANDA HALEY

to

TYLER BLAKE CONNOLLY

SATURDAY, THE FIFTEENTH OF AUGUST
 TWO THOUSAND TWENTY-SIX
 AT FOUR O'CLOCK IN THE AFTERNOON
 MEADOW BROOK HALL
 ROCHESTER, MICHIGAN

RECEPTION IMMEDIATELY FOLLOWING

PLEASE NOTE:

- Embassy invitations may require additional postage.

W-2023

DARCY SUITE • PRICE GROUP A

PAPER CODE	DESCRIPTION	WEIGHT
LC9116	EMBASSY INVITATION	96#
W65	INSIDE ENVELOPE (ungummed)	32#
W85	OUTSIDE ENVELOPE	32#
LE9116	SINGLE ENVELOPE (not shown)	32#

DESIGN ELEMENTS

Lettering	MOZART (script), COPPERPLATE LIGHT CAP (block, shown all small caps), EXCELSIOR GOTHIC (large block names, shown all small caps)
Motif	MOT1470 swash to
Ink	GOLD
Process	THERMOGRAPHY
Lining	LIN200C Gold Leaves on Green (additional - price group HH)
Paper	ECRU KID FINISH®

WELCOME DINNER

*Friday, the second of October
six o'clock*

*Please join us for a casual evening with
dinner, cocktails and socializing*

*Bear Republic Brewing Co
345 Healdsburg Avenue
Healdsburg, California*

MENU

Angie and Samuel

HEALDSBURG COUNTRY GARDENS

OCTOBER 7, 2023



Wild Arugula Salad

WITH SHAVED PARMESAN
PEPITAS & SHERRY VINAIGRETTE

Filet Mignon

WITH CHIMICHURI SAUCE

Marinated Grilled Chicken Breast

WITH MUSHROOMS AND PEPPER

Grilled Salmon

WITH ROASTED CORN RELISH

Mini Pies with Seasonal Fruit

PETALUMA COFFEE & TEA

ISABELLE SUITE

PAPER CODE	DESCRIPTION	WEIGHT	PRICE GROUP
LC1111	EVENT CARD	96#	AA
LC3111	MENU CARD	96#	R
LC1111	RESPONSE/RECEPTION CARD	96#	A
LE1111	RESPONSE ENVELOPE (not shown)	32#	A

DESIGN ELEMENTS

Lettering	DIDOT STD ROMAN (block, shown all upper case with letter spacing added) ROYAL SCRIPT
Motif	MOT1116B Calligraphy Flourish
Ink	FRENCH BLUE
Process	ENGRAVING
Paper	PEARL WHITE KID FINISH®

PLEASE REPLY

BY THE EIGHTEENTH OF SEPTEMBER

M _____

_____ *delighted to attend*

_____ *regretfully decline*

_____ *will attend the Welcome Dinner*



*Doctor and Mrs. Augustine Coletta
request the pleasure of your company
at the marriage of their daughter*

ANGELA LYNNE
to
SAMUEL JOSEPH LANSING

son of Mr. and Mrs. William Lansing

*Saturday, third of October
two thousand twenty-six
at three o'clock
Healdsburg Country Gardens
Healdsburg, California*



RECEPTION TO FOLLOW

820 PALMDALE COURT
PLEASANTON, CALIFORNIA 94588

PLEASE NOTE:

- Embassy invitations may require additional postage.

ISABELLE SUITE • PRICE GROUP A

PAPER CODE	DESCRIPTION	WEIGHT
LC9111	EMBASSY INVITATION	96#
W60	INSIDE ENVELOPE (UNGUMMED)	32#
W80	OUTSIDE ENVELOPE	32#
LE9111	SINGLE ENVELOPE (not shown)	32#

DESIGN ELEMENTS

Lettering	ROYAL SCRIPT DIDOT STD ROMAN (block, shown all upper case with letter spacing added)
Motif	MOT1116B Calligraphy Flourish
Ink	FRENCH BLUE
Process	ENGRAVING
Lining	LIN444J Florentine Garden (additional - price group HH)
Paper	PEARL WHITE KID FINISH®



ESSEX SUITE

PAPER CODE	DESCRIPTION	WEIGHT	PRICE GROUP
LC1116	RECEPTION CARD (shown 2 color)	96#	H
LC1116	RESPONSE CARD	96#	H
LE1116	RESPONSE ENVELOPE (not shown)	32#	H
LF1116	HEAVYWEIGHT NOTE (shown 2 color)	64#	W
LE1116	NOTE ENVELOPE	32#	W

DESIGN ELEMENTS

Lettering	CORONET (block) BICKHAM SWASH
Monogram	MON439A
Motifs	MOT1473A Reception to Follow MOT1472A Floral Ornament MOT1474A Kindly Respond
Inks	GOLD NAVY
Process	ENGRAVING
Lining	LIN443E Metallic Gold (additional - price group HH)
Paper	ECRU KID FINISH®

PLEASE NOTE:

- See Motif Chart for alternate word motifs



TOGETHER WITH THEIR FAMILIES

Kathryn Joanne Bellemore
and
Michael Stephen Hadley

REQUEST THE HONOUR OF YOUR PRESENCE
AS THEY EXCHANGE MARRIAGE VOWS

SATURDAY, THE TWELFTH OF SEPTEMBER
TWO THOUSAND TWENTY-SIX
AT ELEVEN O'CLOCK IN THE MORNING



THE FIRST PRESBYTERIAN CHURCH
GREENWICH, CONNECTICUT

34 Bayberry Lane
GREENWICH, CONNECTICUT 06831

PLEASE NOTE:
• Royalty invitations will require additional postage.

W-2023

ESSEX SUITE • PRICE GROUP H

PAPER CODE	DESCRIPTION	WEIGHT
LC0106	ROYALTY INVITATION (shown 2 color)	96#
W17	INSIDE ENVELOPE (ungummed)	32#
W37	OUTSIDE ENVELOPE	32#
LE0116	SINGLE ENVELOPE (not shown)	32#

DESIGN ELEMENTS

Lettering	CORONET (block), BICKHAM SWASH, BICKHAM SCRIPT
Monogram	MON439C
Motif	MOT1472A Floral Ornament
Inks	GOLD NAVY
Process	ENGRAVING
Lining	LIN131A Navy (additional - price group HH)
Paper	ECRU KID FINISH®

MR. AND MRS. CLARK L BAUER

28 ROSEWOOD COURT

BRIDGEWATER, NEW JERSEY 08807



WILL _____ ATTEND

THE FAVOR OF A REPLY IS REQUESTED
BEFORE THE FIRST OF JULY

Reception

AT FIVE O'CLOCK

CONGRESS HALL

200 CONGRESS PLACE

CAPE MAY, NEW JERSEY

BLACK TIE

NEWPORT SUITE • PRICE GROUP H

PAPER CODE	DESCRIPTION	WEIGHT
LC1116	RESPONSE CARD	96#
LE1116	RESPONSE ENVELOPE	32#
LC1322	BEACH GLASS RECEPTION CARD	96#

DESIGN ELEMENTS

Lettering	EXCELSIOR GOTHIC (block, shown all small caps) ROOK SCRIPT
Monogram	MON542A
Ink	GOLD
Process	ENGRAVING
Paper	ECRU KID FINISH® BEACH GLASS KID FINISH®



MR. AND MRS. CLARK LUNDEN BAUER
AND
MR. AND MRS. KENNETH PAUL CRAMWELL
REQUEST THE HONOUR OF YOUR PRESENCE
AT THE MARRIAGE OF THEIR DAUGHTER

CHELSEA JEANNE

to

BRETT EDWARD WHETHERBY

SON OF MR. AND MRS. CHAD NATHANIEL WEATHERBY

SATURDAY, THE TWENTY-FIFTH OF JULY

TWO THOUSAND TWENTY-SIX

AT HALF AFTER ONE O'CLOCK



CHURCH OF OUR LADY STAR OF THE SEA

CAPE MAY, NEW JERSEY

28 ROSEWOOD COURT
BRIDGEWATER, NEW JERSEY 08807

PLEASE NOTE:

- Royalty invitations will require additional postage.
- Double Envelopes are not available for colored papers.

NEWPORT SUITE • PRICE GROUP H

PAPER CODE	DESCRIPTION	WEIGHT
LC0322	ROYALTY BEACH GLASS INVITATION	96#
LE0322	BEACH GLASS SINGLE ENVELOPE	32#

DESIGN ELEMENTS

Lettering	EXCELSIOR GOTHIC (block, shown all small caps), ROOK SCRIPT
Monogram	MON542A
Motif	MOT1075A Flourish
Ink	GOLD
Process	ENGRAVING
Paper	BEACH GLASS KID FINISH®

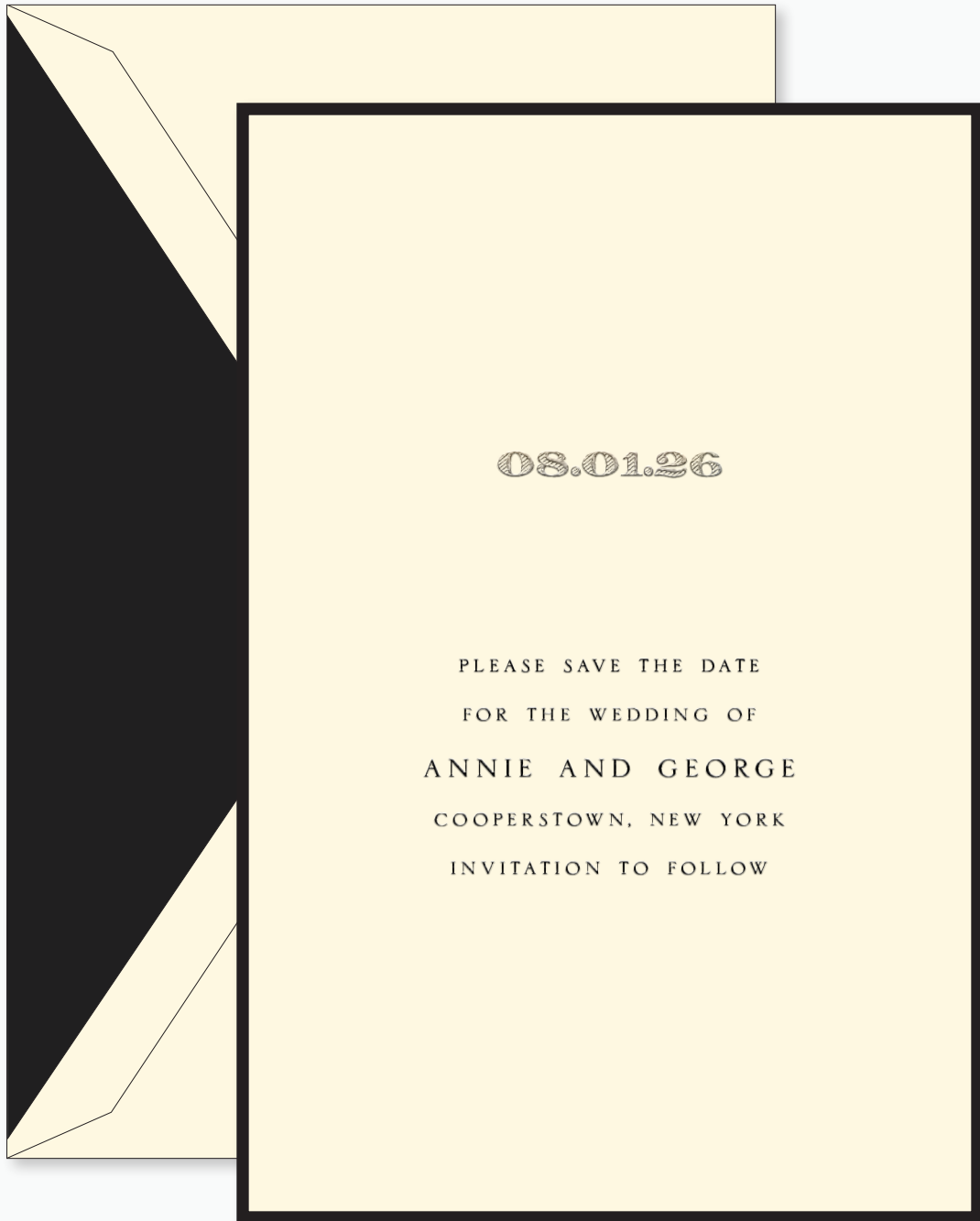

FENIMORE SUITE

PAPER CODE	DESCRIPTION	WEIGHT	PRICE GROUP
C3116BLK	BLACK BORDERED SAVE THE DATE CARD (shown 2 color)	96#	S
LE3116	SAVE THE DATE ENVELOPE	32#	S
V84-130	VALET PARKING CARD	64#	EE
F1116BLK	BLACK BORDERED HEAVYWEIGHT NOTE	64#	X
LE1116	NOTE ENVELOPE	32#	X

DESIGN ELEMENTS

Lettering	SERLIO (block, shown all small caps with letter spacing added) SHADED ROMAN (shaded block)
Monogram	MON556A
Inks	GOLD BLACK
Process	ENGRAVING
Linings	LIN135A Black (additional - price group HH) LIN284B Gold Micro Stripe (additional - price group HH)
Paper	ECRU KID FINISH®

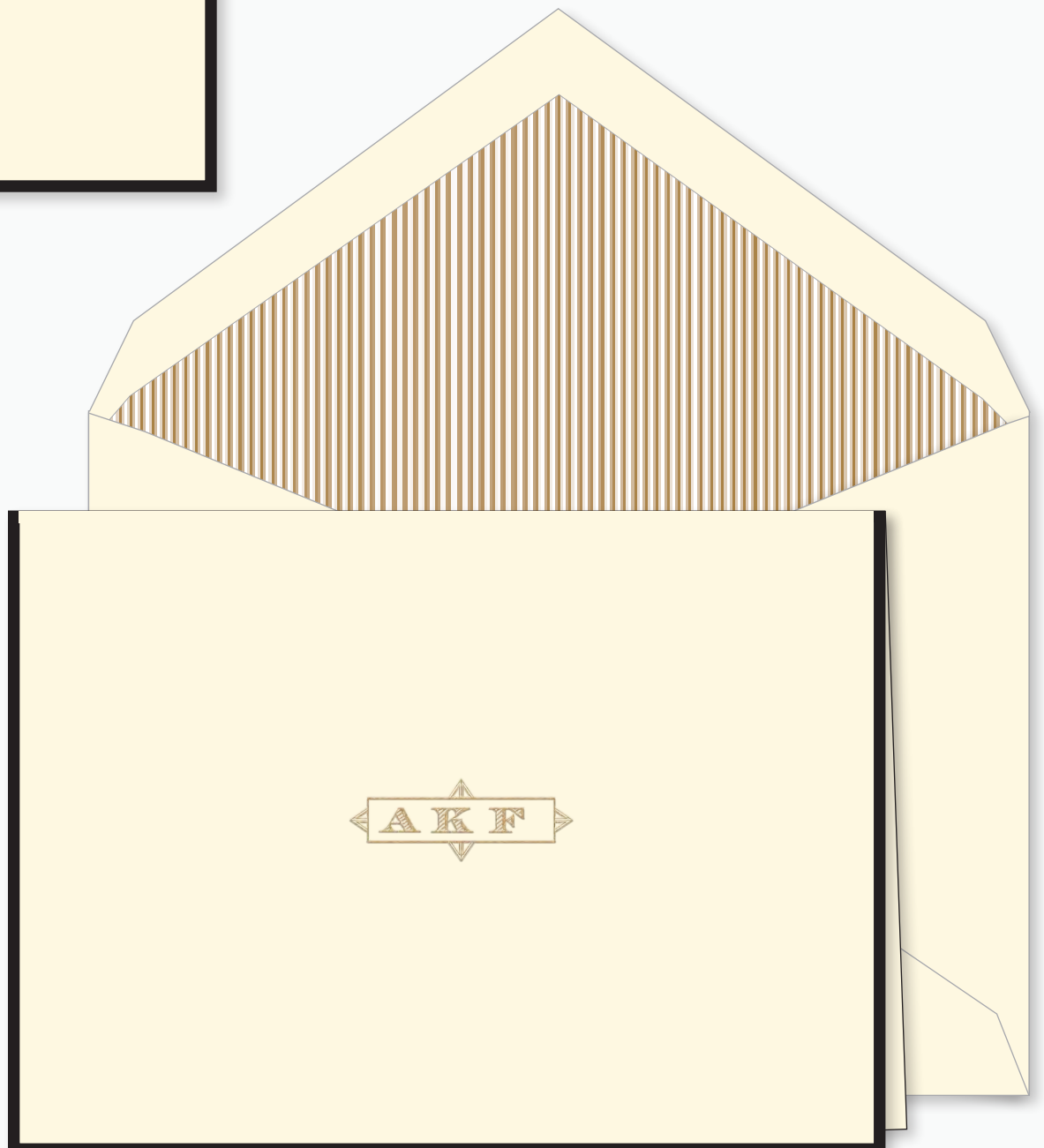
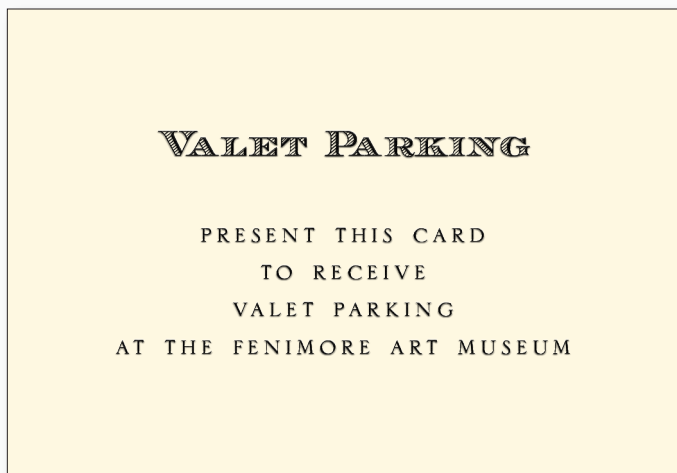

MR. AND MRS. THEODORE FEURY
REQUEST THE PLEASURE OF YOUR COMPANY
AT THE MARRIAGE OF THEIR DAUGHTER

ANNIE KATHERINE
TO
GEORGE ARTHUR LEWIS

SATURDAY, THE FIRST OF AUGUST
TWO THOUSAND TWENTY-SIX
AT HALF AFTER FIVE O'CLOCK
THE LAWN OF THE FENIMORE ART MUSEUM
COOPERSTOWN, NEW YORK

DINNER AND DANCE RECEPTION
IMMEDIATELY FOLLOWING THE CEREMONY

08.01.26

20 KENWICK STREET
NEW YORK, NEW YORK
10013

W-2023

PLEASE REPLY BY
THE FIRST OF JULY

FENIMORE SUITE • PRICE GROUP C

PAPER CODE	DESCRIPTION	WEIGHT
C9116BLK	EMBASSY BLACK BORDERED INVITATION (shown 2 color)	96#
W65	INSIDE ENVELOPE (ungummed)	32#
W85	OUTSIDE ENVELOPE	32#
LE9116	SINGLE ENVELOPE (not shown)	32#
C1116BLK	BLACK BORDERED RESPONSE CARD	96#
LE1116	RESPONSE ENVELOPE (not shown)	32#

DESIGN ELEMENTS

Lettering	SERLIO (block, shown all small caps with letter spacing added) SHADED ROMAN (shaded block)
Inks	GOLD BLACK
Process	ENGRAVING
Paper	ECRU KID FINISH®

in honor of

ann and kevin

july 11, 2026

salad

organic field greens
with goat cheese and caramelized walnuts

main course

peppercorn encrusted salmon
with ginger basil sauce

house made fettuccine

tossed with smoked wild mushrooms
and asiago cheese

tuscan grilled vegetables

kendall jackson chardonnay
smoking loon merlot

dessert

wedding cake

veuve clicquot champagne



FLORAL SUITE

PAPER CODE	DESCRIPTION	WEIGHT	PRICE GROUP
LC3123	LIGHT PINK MENU CARD (shown 2 color)	110C	R
T91-124	PLACE CARD	64#	EE
LN1111	NOTE	32#	V
LE1123	LIGHT PINK NOTE ENVELOPE	32W	V
LE1111	PEARL WHITE NOTE ENVELOPE (not shown)	32#	V

DESIGN ELEMENTS

Lettering **AVANT GARDE PRO BOOK** (block, shown all lowercase with letter spacing added)

FUTURA BOLD (bold block, shown all lowercase with letter spacing added)

Motifs **MOT704A** Floral Dingbat (on menu)

MOT704B Floral Dingbat Smaller (on note and place card)

Inks **GOLD**

KONA

Process **THERMOGRAPHY**

Lining **LIN445E** Vintage Gold Floral (additional - price group HH)

Paper **LIGHT PINK LETTRA IMPRESS**

PEARL WHITE KID FINISH®



ann katherine roch





mr. and mrs. richard roch
 request the honour of your presence
 at the marriage of their daughter

ann kathryn
 to
kevin peter fortnam

saturday, the eleventh of july
 two thousand twenty-six
 at half past two o'clock in the afternoon

st. paul of the cross church
 320 south washington street, park ridge, illinois



PLEASE NOTE:

- Embassy invitations may require additional postage.
- Double Envelopes are not available for colored papers.

the favour of a reply is requested
 before the twenty-seventh of june



m _____

will _____ attend

mr. and mrs. richard roch
 128 south main street, no. 9
 park ridge, illinois 60609

FLORAL SUITE • PRICE GROUP A

PAPER CODE	DESCRIPTION	WEIGHT
LC9123	EMBASSY LIGHT PINK INVITATION (shown 2 color)	110C
LE9111	SINGLE ENVELOPE	32#
LE9123	LIGHT PINK SINGLE ENVELOPE (not shown)	32W
LC1123	LIGHT PINK RESPONSE CARD (shown 2 color)	110C
LE1111	RESPONSE ENVELOPE	32#
LE1123	LIGHT PINK RESPONSE ENVELOPE (not shown)	32W

DESIGN ELEMENTS

Lettering	AVANT GARDE PRO BOOK (block, shown all lowercase with letter spacing added) FUTURA BOLD (bold block, shown all lowercase with letter spacing added)
Motifs	MOT704A Leaf Artwork Large (on invitation) MOT705A Leaf Artwork (on response card)
Inks	GOLD KONA
Process	THERMOGRAPHY
Lining	LIN444J Florentine Garden (additional - price group HH)
Paper	LIGHT PINK LETTRA IMPRESS PEARL WHITE KID FINISH®

DOVER SUITE • PRICE GROUP N

PAPER CODE	DESCRIPTION	WEIGHT
LC1446	PREMIUM WEIGHT STATELY CORNERS ACCOMMODATION CARD	192#
LC1446	PREMIUM WEIGHT STATELY CORNERS RESPONSE/RECEPTION CARD	192#
LE1116	RESPONSE ENVELOPE	32#

DESIGN ELEMENTS

Lettering	CORONET (block) MOZART (script)
Motifs	MOT1477A Details MOT1479A Swash MOT1478A R.S.V.P.
Ink	BLACK
Process	ENGRAVING
Paper	ECRU KID FINISH®

PLEASE NOTE:

- Premium Weight papers are reserved for engraving and letterpress only.
- Premium Weight Stately Corners Card orders will require 14 business days once order is received or final proof is approved, in addition to the printing process turn time.

Details

A BLOCK OF ROOMS HAS BEEN RESERVED
AT THE FOLLOWING HOTELS:

HILTON GARDEN INN
LAKE FOREST METTAWA
RESIDENCE INN CHICAGO
LAKE FOREST METTAWA

PLEASE REFERENCE
THE HALPERIN/BERNS WEDDING AND
MAKE YOUR RESERVATIONS BY AUGUST 23.

OPTIONAL TRANSPORTATION WILL BE
PROVIDED TO AND FROM THE ARMOUR HOUSE
AND FROM THE ABOVE HOTELS.

*For directions and other information
please visit:*

WWW.OLIVIAANDJOSHWED.COM

Mr. and Mrs. Raymond Halperin

384 WEST ERIE STREET

NUMBER 204

CHICAGO, ILLINOIS

60654

R.S.V.P.

BEFORE THE TWENTY-FIRST OF AUGUST

M _____

_____ *accepts with pleasure* _____ *declines with regret*

PLEASE NOTE:

- Royalty invitations will require additional postage.
- Premium Weight papers are reserved for engraving and letterpress only.
- Premium Weight Stately Corners Card orders will require 14 business days once order is received or final proof is approved, in addition to the printing process turn time.



*Mr. and Mrs. Raymond Peter Halperin
request the honour of your presence
at the marriage of their daughter*

Olivia Stephanie

to

Joshua Robert Berns

Sunday, the sixth of September

two thousand twenty-six

at half after five o'clock in the afternoon

The Armour House

Lake Forest, Illinois

Dinner and Dancing to follow

384 WEST ERIE STREET • NUMBER 204
Chicago, Illinois 60654

W-2023

DOVER SUITE • PRICE GROUP N

PAPER CODE	DESCRIPTION	WEIGHT
LCR0446	ROYALTY PREMIUM WEIGHT STATELY CORNERS INVITATION	192#
W17	INSIDE ENVELOPE (ungummed)	32#
W37	OUTSIDE ENVELOPE	32#
LE0116	SINGLE ENVELOPE (not shown)	32#

DESIGN ELEMENTS

Lettering	MOZART (script) CORONET (block on envelope)
Ink	BLACK
Process	ENGRAVING
Lining	LIN099D Linen Gold (additional - price group HH)
Paper	ECRU KID FINISH®

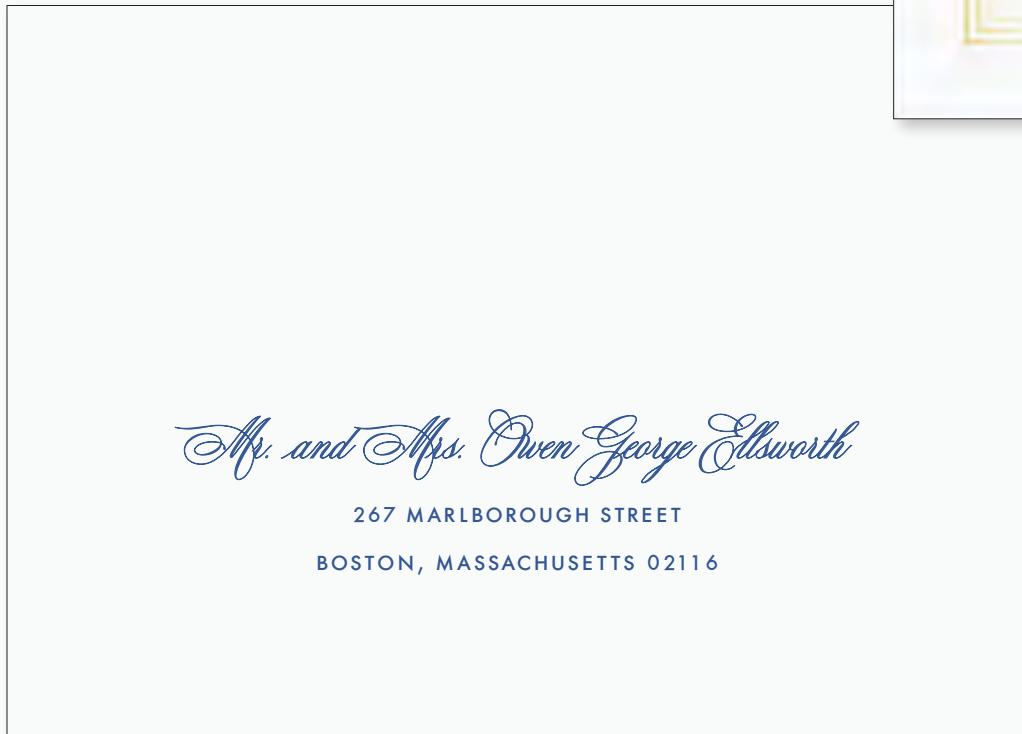
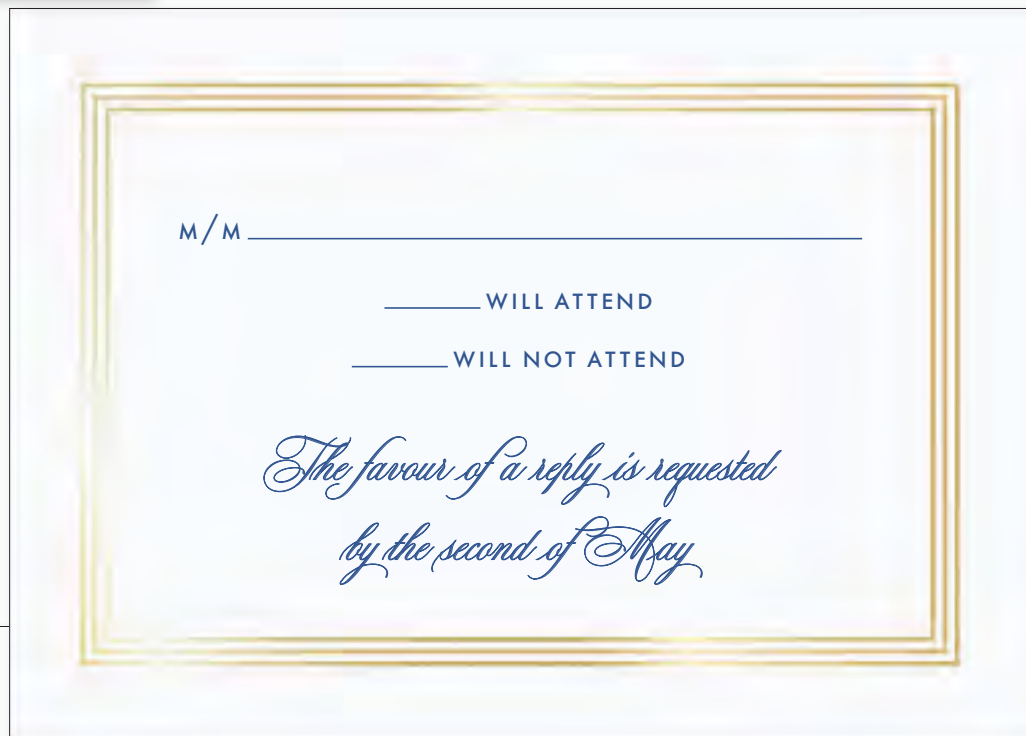

CAMBRIDGE SUITE • PRICE GROUP I

PAPER CODE	DESCRIPTION	WEIGHT
LC1871	GOLD TRIPLE BORDER FRAME RECEPTION CARD	96#
LC1871	GOLD TRIPLE BORDER FRAME RESPONSE CARD	96#
LE1111	RESPONSE ENVELOPE	32#

DESIGN ELEMENTS

Lettering	FUTURA BOOK (block) MOZART (script)
Motif	MOT1484A Reception
Ink	REGENT BLUE
Process	THERMOGRAPHY
Paper	PEARL WHITE KID FINISH®

267 MARLBOROUGH STREET
 BOSTON, MASSACHUSETTS 02116



MR. AND MRS. OWEN GEORGE ELLSWORTH & MR. AND MRS. BRADFORD JAMES ETHERIDGE
 REQUEST THE HONOUR OF YOUR PRESENCE AT THE MARRIAGE OF THEIR CHILDREN

Hannah Grace & Andrew John

SATURDAY, THE TWENTY-THIRD OF MAY, TWO THOUSAND TWENTY-SIX
 AT HALF AFTER FIVE O'CLOCK

BASILICA OF OUR LADY OF PERPETUAL HELP
 1545 TREMONT STREET
 BOSTON, MASSACHUSETTS

W-2023

CAMBRIDGE SUITE • PRICE GROUP I

PAPER CODE	DESCRIPTION	WEIGHT
LC0871	GOLD TRIPLE BORDER FRAME ROYALTY INVITATION (shown 2 color)	96#
W13	INSIDE ENVELOPE (ungummed)	32#
W33	OUTSIDE ENVELOPE	32#
LE0111	SINGLE ENVELOPE (not shown)	32#

DESIGN ELEMENTS

Lettering	FUTURA BOOK (block) MOZART (script)
Monogram	MON455B
Inks	GOLD REGENT BLUE
Process	THERMOGRAPHY
Lining	LIN009A Regent Blue (additional - price group HH)
Paper	PEARL WHITE KID FINISH®

PLEASE NOTE:

- Gold Triple Border Frame Royalty invitations will require additional postage.

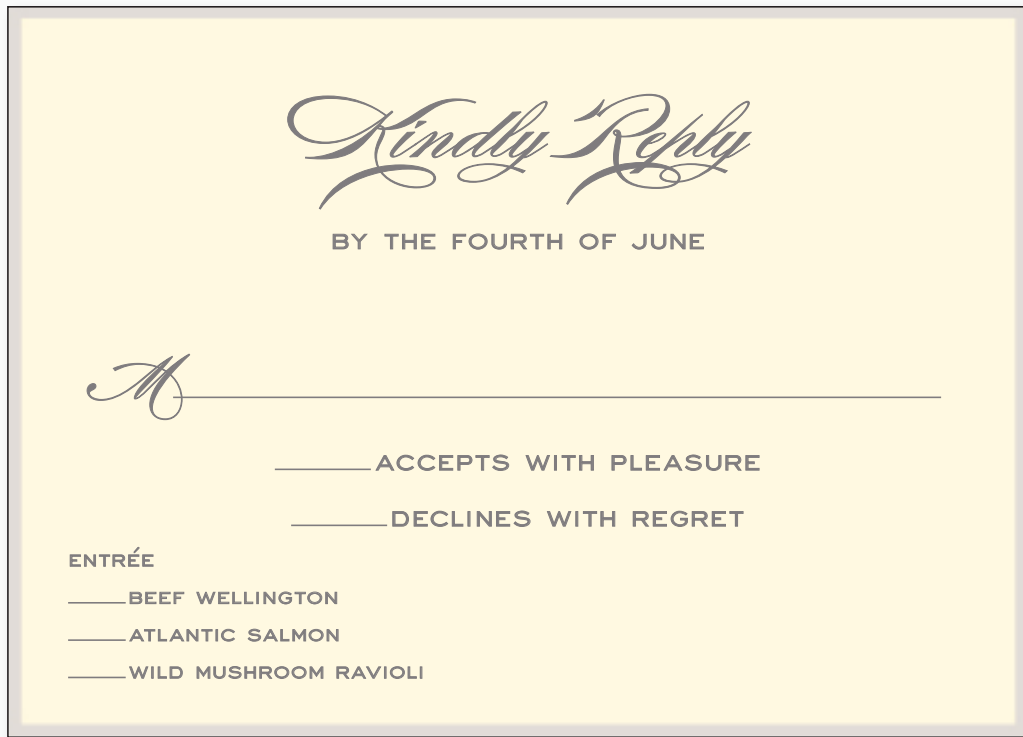

EMMA SUITE

PAPER CODE	DESCRIPTION	WEIGHT	PRICE GROUP
C1116PRL	PEARL BORDERED RESPONSE/RECEPTION CARD	96#	C
LE1116	RESPONSE ENVELOPE (not shown)	32#	C
V31-130	TABLE CARD	96#	EE
E82-130	TABLE CARD ENVELOPE	32#	EE
LF1116	HEAVYWEIGHT NOTE	64#	W
LE1116	NOTE ENVELOPE	32#	W

DESIGN ELEMENTS

Lettering	EXCELSIOR GOTHIC (block, shown all small caps) BURGUES SCRIPT
Motif	MOT545A Flourish
Ink	PEWTER
Process	THERMOGRAPHY
Lining	LIN391B Pearl Stripe (additional - price group HH)
Paper	ECRU KID FINISH®



426 MOUNT VERNON STREET
PHILADELPHIA, PENNSYLVANIA 19130



Lauren Jayne Hardy
and
Jonathan Mark Warren

REQUEST THE PLEASURE OF YOUR COMPANY
AT THE CELEBRATION OF THEIR MARRIAGE
FRIDAY, THE TWENTY-SEVENTH OF JUNE
TWO THOUSAND TWENTY-SIX
AT FIVE O'CLOCK

Knottton Mansion
PHILADELPHIA, PENNSYLVANIA



RECEPTION IMMEDIATELY FOLLOWING

BLACK TIE INVITED

PLEASE NOTE:

- Embassy invitations may require additional postage.

W-2023

EMMA SUITE • PRICE GROUP C

PAPER CODE	DESCRIPTION	WEIGHT
C9116PRL	EMBASSY PEARL BORDERED INVITATION	96#
W65	INSIDE ENVELOPE (ungummed)	32#
W85	OUTSIDE ENVELOPE	32#
LE9116	SINGLE ENVELOPE (not shown)	32#

DESIGN ELEMENTS

Lettering	BURGUES SCRIPT EXCELSIOR GOTHIC (block, shown all small caps)
Motif	MOT545A Flourish
Ink	PEWTER
Process	THERMOGRAPHY
Lining	LIN278B Champagne Shimmer (additional - price group HH)
Paper	ECRU KID FINISH®

Kindly reply before September seventeenth

*Elena and Benjamin Adamson
842 Dunvegan Road
Toronto, Ontario
M5P 2P2*

*Valet Parking
The Royal Ontario Museum
Bloor Street Entrance*

WARWICK SUITE

PAPER CODE	DESCRIPTION	WEIGHT	PRICE GROUP
LC1116	RECEPTION/RESPONSE CARD	96#	E
LE1116	RESPONSE ENVELOPE (not shown)	32#	E
V31-130	VALET PARKING CARD	96#	EE
LC1116	EVENT CARD	96#	AA

DESIGN ELEMENTS

Lettering	ROOK SCRIPT
Ink	NAVY
Process	ENGRAVING
Paper	ECRU KID FINISH®

*Please join us for
Cocktails and Light Fare
on Saturday, October seventeenth
at six o'clock in the evening
842 Dunvegan Road
The Adamsons*

842 Dunvegan Road
 Toronto, Ontario
 M5P 2P2

ב"ה

*Elena and Benjamin Adamson
 Eve and Joel Langer
 request the honour of your presence
 at the marriage of their children*

Hailey Abigail

and

Benjamin Levi

Sunday, the eighteenth of October

Chuppah at six-thirty in the evening

The Royal Ontario Museum

Toronto

PLEASE NOTE:

- Embassy folders may require additional postage.
- See Hebrew page for alternate Hebrew phrase motifs.

WARWICK SUITE • PRICE GROUP E

PAPER CODE	DESCRIPTION	WEIGHT
LF9116	EMBASSY INVITATION	64#
W65	INSIDE ENVELOPE (ungummed)	32#
W85	OUTSIDE ENVELOPE	32#
LE9116	SINGLE ENVELOPE (not shown)	32#

DESIGN ELEMENTS

Lettering	ROOK SCRIPT
Motif	MOT1123A Bays Hay
Inks	NAVY
	BLIND EMBOSS
Processes	ENGRAVING
	BLIND EMBOSSING
Lining	LIN131A Navy (additional - price group HH)
Paper	ECRU KID FINISH®

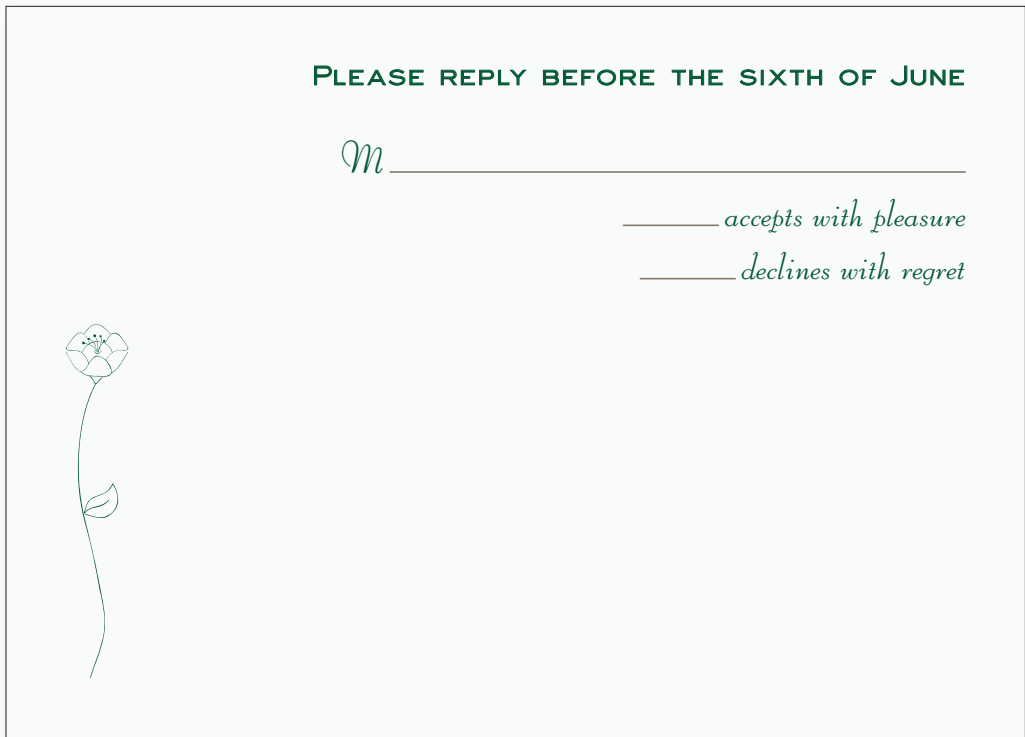
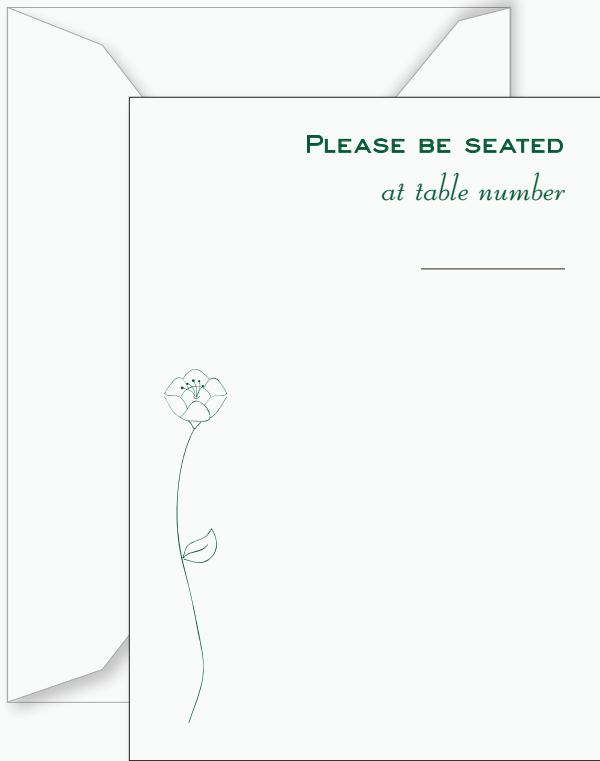

POPPY SUITE

PAPER CODE	DESCRIPTION	WEIGHT	PRICE GROUP
V91-130	TABLE CARD	64#	EE
E91-130	TABLE CARD ENVELOPE	32#	EE
LC1111	RESPONSE CARD	96#	AA
LE1111	RESPONSE ENVELOPE	32#	AA
LN1111	NOTE	32#	V
LE1111	NOTE ENVELOPE	32#	V

DESIGN ELEMENTS

Lettering	LIBERTY SCRIPT EXCELSIOR GOTHIC (block)
Motif	MOT693B Flower Small
Ink	HUNTER GREEN
Process	THERMOGRAPHY
Lining	LIN466A Hibiscus (additional - price group HH)
Paper	PEARL WHITE KID FINISH®

BRIGHTON FARMS
 5268 Pasture Way
 Brentwood, Tennessee 37027

Mr. and Mrs. Kenneth Foley Brighton
 request the honour of your presence
 at the marriage of their daughter

DARBY MICHELLE TO
MR. FINN COLE MONTGOMERY

Saturday, the twentieth of June
Two thousand twenty-six
at three o'clock in the afternoon
Holy Family Catholic Church
Brentwood, Tennessee



PLEASE NOTE:
 • Double Envelopes are not available for monarch papers.

DINNER AND DANCING
FOLLOWING THE CEREMONY
The Governors Club
9681 Concord Road
Brentwood, Tennessee



POPPY SUITE

PAPER CODE	DESCRIPTION	WEIGHT	PRICE GROUP
LC7111	MONARCH INVITATION	96#	P
LE7111	SINGLE ENVELOPE	32#	P
LC1111	RECEPTION CARD	96#	AA

DESIGN ELEMENTS

Lettering	LIBERTY SCRIPT EXCELSIOR GOTHIC (block)
Motifs	MOT693A Flower (on invitation) MOT693B Flower Small (on reception card)
Ink	HUNTER GREEN
Process	THERMOGRAPHY
Paper	PEARL WHITE KID FINISH®

MR. AND MRS. THOMAS JASPER CARLISLE
 832 BEECHWOOD AVENUE
 NASHVILLE, TENNESSEE 37212

The favour of a reply is requested
 BY THE SEVENTH OF AUGUST

M _____

_____ ACCEPT WITH PLEASURE
 _____ DECLINE WITH REGRET
 NUMBER ATTENDING _____

BRITTANY SUITE

PAPER CODE	DESCRIPTION	WEIGHT	PRICE GROUP
LC1536	BEVELED PANEL RESPONSE/RECEPTION CARD	96#	I
LE1116	RESPONSE ENVELOPE	32#	I
LF1116	HEAVYWEIGHT NOTE	64#	W
LE1116	NOTE ENVELOPE	32#	W

DESIGN ELEMENTS

Lettering BICKHAM SWASH, SERLIO (block), BICKHAM SCRIPT
 Monogram MON303A
 Ink POLISHED COPPER
 Process ENGRAVING
 Lining LIN792A Rose Gold (additional - price group HH)
 Paper ECRU KID FINISH®





BRITTANY SUITE • PRICE GROUP I

PAPER CODE	DESCRIPTION	WEIGHT
LC0536	ROYALTY BEVELED PANEL INVITATION	96#
W17	INSIDE ENVELOPE (ungummed)	32#
W37	OUTSIDE ENVELOPE	32#
LE0116	SINGLE ENVELOPE (not shown)	32#

DESIGN ELEMENTS

Lettering	SERLIO (block), BICKHAM SWASH
Monogram	MON303B
Motif	MOT1482A Swash to
Ink	POLISHED COPPER
Process	ENGRAVING
Lining	LIN122D Ecru Moire (additional - price group HH)
Paper	ECRU KID FINISH®

ISLAND SUITE • PRICE GROUP A

PAPER CODE	DESCRIPTION	WEIGHT
LC1322	BEACH GLASS SAVE THE DATE CARD	96#
LE1123	LIGHT PINK ENVELOPE	32W
LC1123	LIGHT PINK RESPONSE CARD	110C
LE1112	LIGHT GRAY RESPONSE ENVELOPE	32W

DESIGN ELEMENTS

Lettering	EXCELSIOR GOTHIC (block, shown all small caps), AVANT GARDE PRO BOOK (block, shown all lower case)
Ink	HUNTER GREEN
Process	ENGRAVING
Paper	BEACH GLASS KID FINISH® LIGHT PINK LETTRA IMPRESS LIGHT GRAY LETTRA IMPRESS

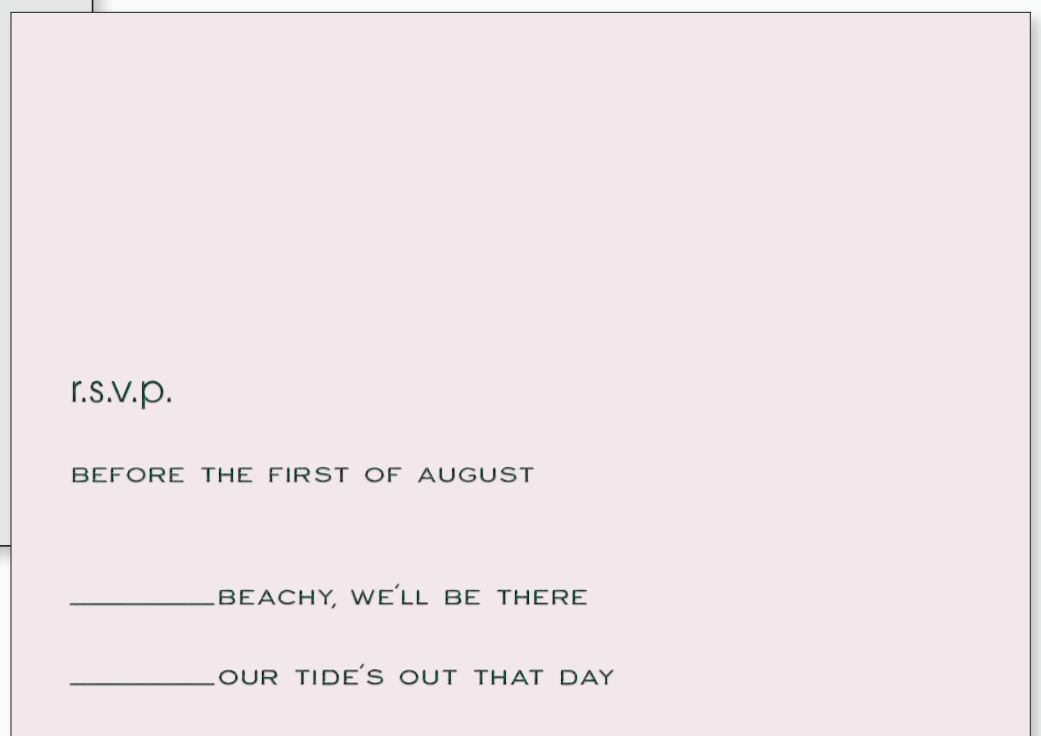
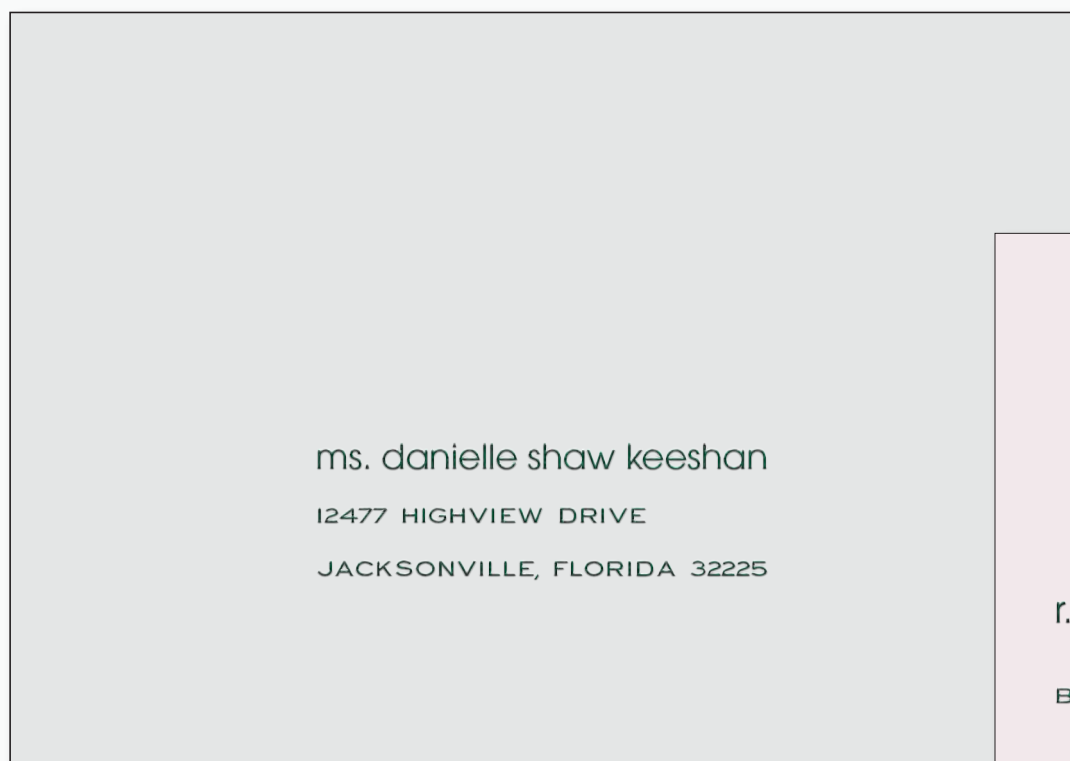

PLEASE NOTE:

- Embassy invitations may require additional postage.
- Double Envelopes are not available for colored papers.

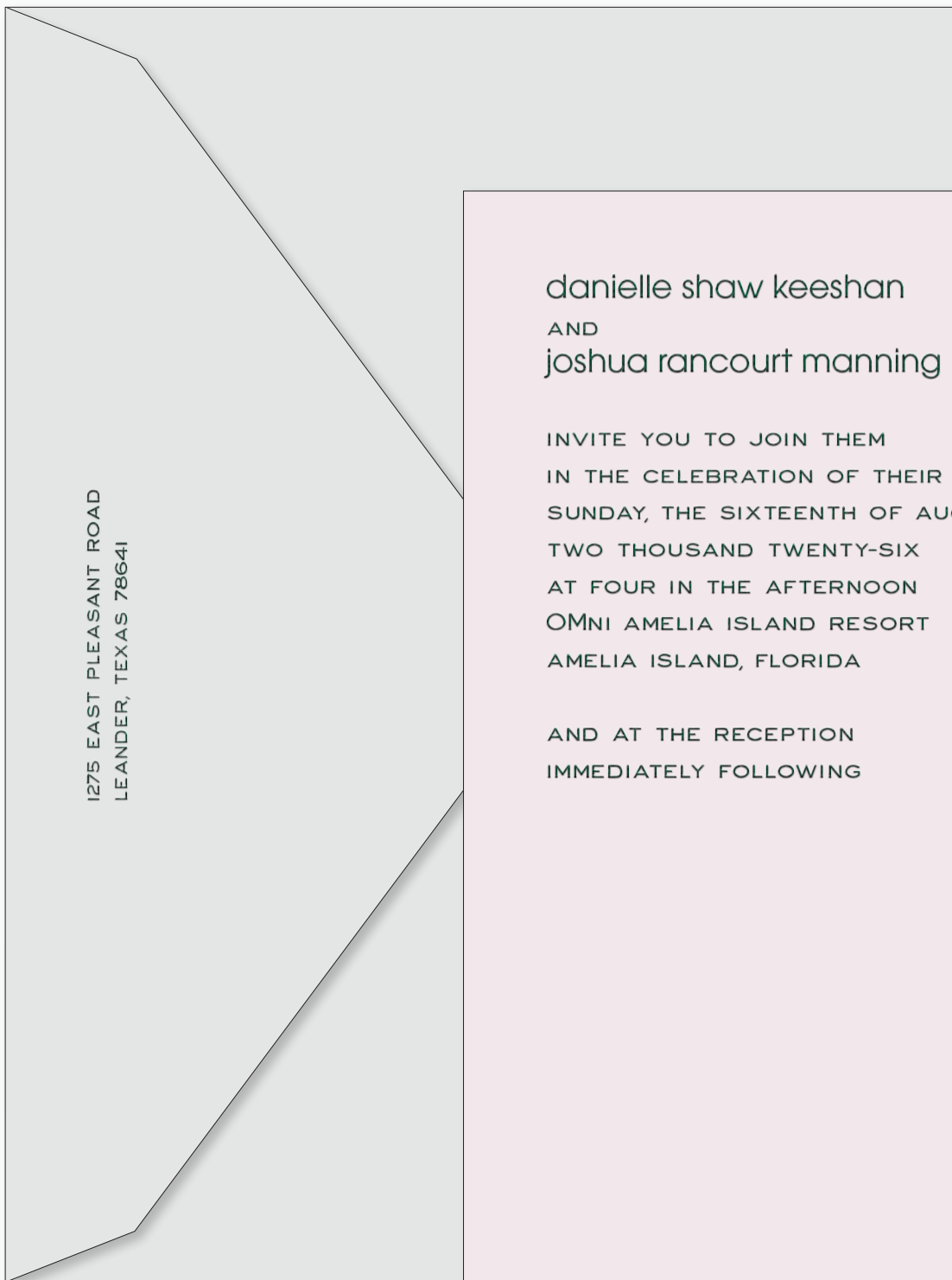

danielle shaw keeshan
AND
joshua rancourt manning

INVITE YOU TO JOIN THEM
IN THE CELEBRATION OF THEIR MARRIAGE
SUNDAY, THE SIXTEENTH OF AUGUST
TWO THOUSAND TWENTY-SIX
AT FOUR IN THE AFTERNOON
OMNI AMELIA ISLAND RESORT
AMELIA ISLAND, FLORIDA

AND AT THE RECEPTION
IMMEDIATELY FOLLOWING

ISLAND SUITE

PAPER CODE	DESCRIPTION	WEIGHT	PRICE GROUP
LC9123	EMBASSY LIGHT PINK INVITATION	110C	A
LE9112	LIGHT GRAY SINGLE ENVELOPE	32W	A
LE9123	LIGHT PINK SINGLE ENVELOPE (not shown)	32W	A
V19-130	BEACH GLASS ACCOMMODATIONS CARD	96#	EE

DESIGN ELEMENTS

Lettering	EXCELSIOR GOTHIC (block, shown all small caps) AVANT GARDE PRO BOOK (block, shown all lower case)
Ink	HUNTER GREEN
Process	ENGRAVING
Paper	LIGHT PINK LETTRA IMPRESS LIGHT GRAY LETTRA IMPRESS BEACH GLASS KID FINISH®

A BLOCK OF ROOMS
HAS BEEN RESERVED UNDER
the keeshan/manning wedding
AT THE OMNI AMELIA ISLAND RESORT

WE HOPE TO SEE YOU THERE!

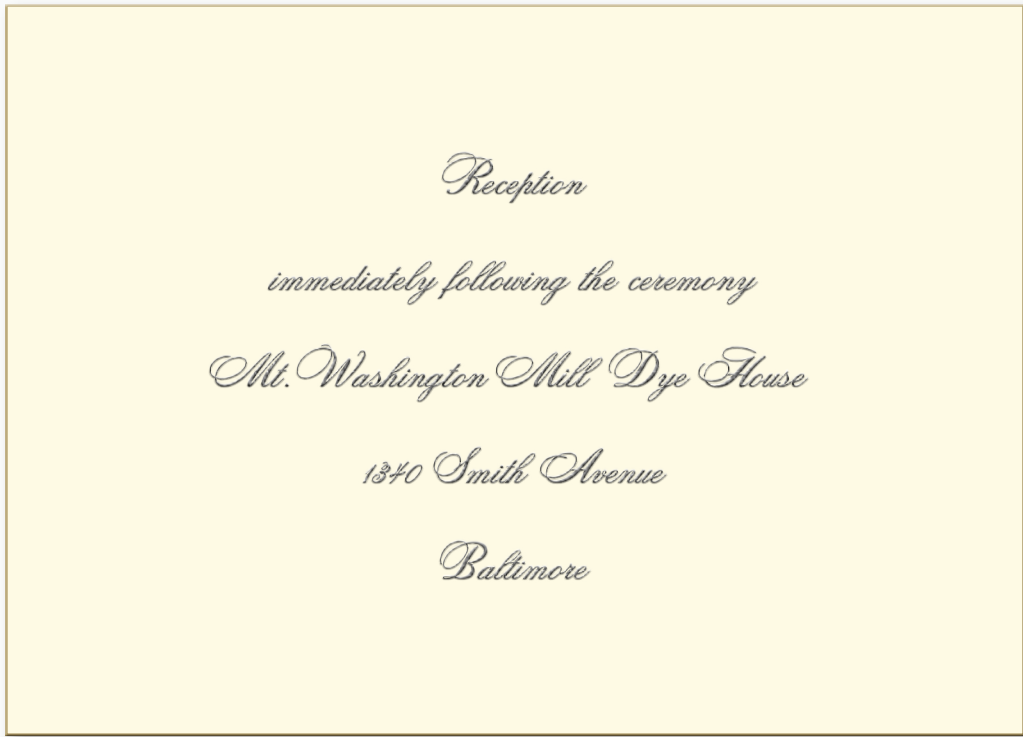

CHARLOTTE SUITE

PAPER CODE	DESCRIPTION	WEIGHT	PRICE GROUP
LC1066	PREMIUM WEIGHT GILT EDGE RESPONSE/RECEPTION CARD	192#	B
LE1116	RESPONSE ENVELOPE	32#	B
V31-130	INFORMATION CARD	96#	EE
LF1116	HEAVYWEIGHT NOTE	64#	W
LE1116	NOTE ENVELOPE	32#	W

DESIGN ELEMENTS

Lettering	CITADEL SCRIPT
Monogram	MON200D
Inks	PEWTER
	BLIND EMBOSS
Processes	ENGRAVING
	BLIND EMBOSSING
Lining	LIN1078B Gray Floral (additional - price group HH)
Paper	ECRU KID FINISH®



*3201 West Lake Avenue
Baltimore, Maryland 21210*

*Mr. and Mrs. Darren Herbert Richardson
and
Ms. Shannon Kelley Parker
request the honour of your presence
at the marriage of their daughter*

Elizabeth Parker Richardson

to

Phillip Cameron Wilson

son of

Mr. and Mrs. Timothy Ian Wilson

Saturday, the fourteenth of November

Two thousand twenty-six

at four o'clock

*The Chapel of the Church of the Redeemer
Baltimore, Maryland*

PLEASE NOTE:

- Embassy invitations may require additional postage.

CHARLOTTE SUITE • PRICE GROUP B

PAPER CODE	DESCRIPTION	WEIGHT
LC9066	EMBASSY PREMIUM WEIGHT GILT EDGE INVITATION	192#
W65	INSIDE ENVELOPE (ungummed)	32#
W85	OUTSIDE ENVELOPE	32#
LE9116	SINGLE ENVELOPE (not shown)	32#

DESIGN ELEMENTS

Lettering	CITADEL SCRIPT
Ink	PEWTER
Process	ENGRAVING
Lining	LIN391B Pearl Stripe (additional - price group HH)
Paper	ECRU KID FINISH®

A M T



FIRST COURSE

FARM FRESH GREENS

TOASTED ALMONDS, CRANBERRIES, GOAT CHEESE
BALSAMIC VINAIGRETTE

ENTRÉE SELECTION

GRILLED BEEF TENDERLOIN

WITH NATIVE MAINE LOBSTER TAIL
ROASTED FINGERLING POTATOES, GRILLED ASPARAGUS

CORIANDER CRUSTED SEA BASS

WITH GRILLED VEGETABLE BASMATI RICE, BABY CARROTS

PHYLLO STAR

WITH ROASTED EGGPLANT AND OVEN DRIED TOMATO

DESSERT

MADAGASCAR VANILLA WEDDING CAKE

WITH RASPBERRY COULIS, CRÉME ANGLAISE AND FRESH BERRIES



Welcome Dinner

FRIDAY, 7:00 P.M.

THE SCHOONER AURORA

Brunch with us!

SUNDAY, 10:00 A.M. TO NOON

THE UPPER DECK

AT OCEANCLIFF



FOR ACCOMMODATIONS

AND ALL THE DETAILS

PLEASE VISIT

WWW.ADELLEANDTHEO.COM

KINDLY REPLY

before

MAY TWENTY-NINTH

M _____

ACCEPTS

WITH PLEASURE

N^e _____

DECLINES

WITH REGRET

N^e _____

PLEASE NOTE:

- Marquis cards will require additional postage.
- Premium Weight papers are reserved for engraving and letterpress only.
- Premium Weight Gold Ink Edged orders will require 14 business days once order is received or final proof is approved, in addition to the printing process turn time.

REGENCY SUITE

PAPER CODE	DESCRIPTION	WEIGHT	PRICE GROUP
LCM116	MARQUIS CARD (shown as a Menu in two colors)	96#	H
LEM136	INSIDE ENVELOPE (ungummed, not shown)	32#	H
LEM146	OUTSIDE ENVELOPE (not shown)	32#	H
LEM136G	SINGLE ENVELOPE (not shown)	32#	W
LC1996	PREMIUM WEIGHT GOLD INK EDGED EVENT CARD	192#	O
LC1996	PREMIUM WEIGHT GOLD INK EDGED RESPONSE/RECEPTION CARD	192#	O
LE1116	RESPONSE ENVELOPE (not shown)	32#	O
DESIGN ELEMENTS			
Lettering	CHEVALIER STD STRIPE (shaded) BAUER BODONI ITALIC (italic, shown all caps with letter spacing added) CORONET (block) MOZART (script)		
Monogram	MON505A		
Motifs	MOT1298A Flourish Top MOT1301B Flourish Bottom MOT033A Anchor MOT1510A Accepts/Declines with No.		
Inks	NAVY GOLD		
Process	ENGRAVING		
Paper	ECRU KID FINISH®		

MR. AND MRS. JAMES ALLEN RANDOLPH
REQUEST THE PLEASURE OF YOUR COMPANY
AT THE MARRIAGE OF THEIR DAUGHTER



ADELLE
KATHERINE

to

THEODORE
WESLEY MARTIN



SATURDAY, THE THIRTEENTH OF JUNE
TWO THOUSAND TWENTY-SIX
AT FOUR O'CLOCK IN THE AFTERNOON

THE REGATTA PLACE
NEWPORT, RHODE ISLAND

Reception to follow



PLEASE NOTE:

- Royalty invitations will require additional postage.
- Premium Weight papers are reserved for engraving and letterpress only.
- Premium Weight Gold Ink Edged orders will require 14 business days once order is received or final proof is approved, in addition to the printing process turn time.

REGENCY SUITE • PRICE GROUP O

PAPER CODE	DESCRIPTION	WEIGHT
LCR0996	PREMIUM WEIGHT GOLD INK EDGED ROYALTY INVITATION	192#
W17	INSIDE ENVELOPE (ungummed, not shown)	32#
W37	OUTSIDE ENVELOPE (not shown)	32#
LE0116	SINGLE ENVELOPE	32#

DESIGN ELEMENTS

Lettering	CHEVALIER STD STRIPE (shaded), CORONET (block) DIDOT STD ROMAN (large block, shown all upper case), MOZART (script) BAUER BODONI ITALIC (italic, shown all upper case with letter spacing added)
Motifs	MOT1298A Flourish Top MOT1301B Flourish Bottom MOT1509A Reception to Follow
Inks	NAVY, GOLD
Process	ENGRAVING
Lining	LIN292C Regency (additional - price group HH)
Paper	ECRU KID FINISH®

celebrating

CATHERINE

AND

STANFORD

menu

SALAD OF MIXED GREENS
WARM CHEVRE, TOMATOES
PORTOBELLO MUSHROOMS

FILET MIGNON
PERIGOURDINE SAUCE AND SHAVED TRUFFLES
ROASTED POTATOES, HARICOT VERTS
GLAZED BABY CARROTS

CHOCOLATE DIPPED STRAWBERRIES
WEDDING CAKE

*271 ridgefield road, no. 6
stamford, connecticut 06614*

catherine

AND

stanford

save

THE

date

CATHERINE BROWN
and
STANFORD MARKSMAN

are
GETTING MARRIED

on
AUGUST 8TH, 2026

invitation to follow

STANFORD SUITE

PAPER CODE	DESCRIPTION	WEIGHT	PRICE GROUP
LC3482	NAVY MENU	96#	R
F1111NVY	NAVY BORDERED HEAVYWEIGHT NOTE	64#	X
LE1482	NAVY NOTE ENVELOPE	32#	X
LC1482	NAVY SAVE THE DATE	96#	A
LE1111	SAVE THE DATE ENVELOPE	32#	A
LE1482	NAVY SAVE THE DATE ENVELOPE (not shown)	32#	A

DESIGN ELEMENTS

Lettering	BICKHAM SCRIPT (shown all lower case) SERLIO (block, shown all small caps with letter spacing added)
Motifs	MOT1323A Rule line with "and" (shown on menu and note) MOT1339A Rule line with "the" (shown on save the date)
Inks	WHITE NAVY
Process	ENGRAVING
Lining	LIN131A Navy (additional - price group HH)
Paper	NAVY KID FINISH® PEARL WHITE KID FINISH®

PLEASE NOTE:

- Navy papers are reserved for engraving and blind embossing only

PLEASE NOTE:

- Embassy invitations may require additional postage.
- Double Envelopes are not available for colored papers.
- Navy papers are reserved for engraving and blind embossing only

catherine

AND

stanford

MR. AND MRS. PATRICK ALLEN BROWN
REQUEST THE HONOUR OF YOUR PRESENCE

at

THE MARRIAGE OF THEIR DAUGHTER
CATHERINE LOUISE

to

STANFORD THOMAS MARKSMAN

on

SATURDAY, THE EIGHTH OF AUGUST
TWO THOUSAND TWENTY-SIX
SIX O'CLOCK IN THE EVENING

at

OLD LYME CONGREGATIONAL CHURCH
OLD LYME, CONNECTICUT

favour

OF

*a reply**by*

THE TWENTIETH OF JULY

STANFORD SUITE • PRICE GROUP A

PAPER CODE	DESCRIPTION	WEIGHT
LC9482	EMBASSY NAVY INVITATION	96#
LE9482	NAVY SINGLE ENVELOPE	32#
LE9111	PEARL WHITE SINGLE ENVELOPE	
	(not shown)	32#
LC1111	RESPONSE CARD	96#
LE1111	RESPONSE CARD ENVELOPE	
	(not shown)	32#
LE1482	NAVY RESPONSE CARD	
	ENVELOPE (not shown)	32#

DESIGN ELEMENTS

Lettering	BICKHAM SCRIPT (shown all lower case) SERLIO (block, shown all small caps with letter spacing added)
Motifs	MOT1323A Rule line with "and" (shown on invitation) MOT1341A Rule line with "of" (shown on response)
Inks	WHITE NAVY
Process	ENGRAVING
Lining	LIN123D White Moire (additional - price group HH)
Paper	NAVY KID FINISH® PEARL WHITE KID FINISH®



MR. AND MRS. KENNETH MATHIEWS
 INVITE YOU TO JOIN THEM FOR THE
 REHEARSAL DINNER
 IN HONOR OF

KELSEA and ROBERT

FRIDAY, THE THIRTEENTH OF FEBRUARY
 TWO THOUSAND TWENTY-SIX
 AT SIX O'CLOCK IN THE EVENING
 TIDELINE RESORT
 PALM BEACH, FLORIDA

RSVP 555-1212



RECEPTION

AT HALF AFTER FIVE O'CLOCK



CAFÉ BOULUD
THE BRAZILIAN COURT HOTEL
 PALM BEACH

ROCHESTER SUITE

PAPER CODE	DESCRIPTION	WEIGHT	PRICE GROUP
GB9116	EMBASSY GOLD BEVEL INVITATION	96#	B
LE9116	SINGLE ENVELOPE (not shown)	32#	B
GB1206	PREMIUM WEIGHT GOLD BEVEL		
	RECEPTION CARD (shown 2 color)	192#	M
GB1116	GOLD BEVEL RESPONSE CARD	96#	B
LE1116	RESPONSE ENVELOPE (not shown)	32#	B

DESIGN ELEMENTS

Lettering	SERLIO (block, shown all small caps with letter spacing added) CHEVALIER STD STRIPE (shaded) BICKHAM SCRIPT
Monogram	MON532A
Motif	MOT570D Swirl
Inks	GOLD BLACK
Process	ENGRAVING
Paper	ECRU KID FINISH®

PLEASE NOTE:

- Embassy invitations may require additional postage.
- Premium Weight papers are reserved for engraving and letterpress only.

R.S.V.P.

BY THE THIRTIETH OF JANUARY

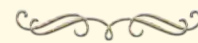



MR. AND MRS. RICHARD GAVIN STANLEY
 REQUEST THE HONOUR OF YOUR PRESENCE
 AT THE MARRIAGE OF THEIR DAUGHTER

KELSEA ANNE

to

MR. ROBERT ALAN MATHIEWS

SATURDAY, THE FOURTEENTH OF FEBRUARY
 TWO THOUSAND TWENTY-SIX
 AT THREE O'CLOCK



BETHESDA-BY-THE-SEA EPISCOPAL CHURCH
 PALM BEACH, FLORIDA

10873 EGRET POINTE LANE
 WEST PALM BEACH, FLORIDA 33412

PLEASE NOTE:

- Royalty invitations are not available with die cuts or bleed motifs and will require additional postage.
- Premium Weight papers are reserved for engraving and letterpress only.

W-2023

ROCHESTER SUITE • PRICE GROUP M

PAPER CODE	DESCRIPTION	WEIGHT
LCR0206	ROYALTY PREMIUM WEIGHT GOLD BEVEL INVITATION (shown 2 color)	192#
W17	INSIDE ENVELOPE (ungummed)	32#
W37	OUTSIDE ENVELOPE	32#
LE0116	SINGLE ENVELOPE (not shown)	32#

DESIGN ELEMENTS

Lettering	SERLIO (block, shown all small caps with letter spacing added) CHEVALIER STD STRIPE (shaded)
Monogram	MON532A
Motifs	MOT1482A Swash to MOT570D Swirl
Inks	GOLD BLACK
Process	ENGRAVING
Lining	LIN099D Linen Gold (additional - price group HH)
Paper	ECRU KID FINISH®

*The favour of your reply
is requested by the second of October*

*M _____
will _____ attend*

Doctor and Mrs. James Michael Randolph

341 Clay Street

Franklin, Virginia 23851

LOIRE SUITE • PRICE GROUP C

PAPER CODE	DESCRIPTION	WEIGHT
C1116GLD	GOLD BORDERED RESPONSE CARD	96#
LE1116	RESPONSE ENVELOPE	32#
C1116GLD	GOLD BORDERED RECEPTION CARD	96#

DESIGN ELEMENTS

Lettering	ANGELINA ONE
Ink	NAVY
Process	THERMOGRAPHY
Paper	ECRU KID FINISH®

Reception to follow

The Commonwealth Club

401 West Franklin Street

*341 Clay Street
Franklin, Virginia 23851*

*Dr. and Mrs. James Michael Randolph
request the honour of your presence
at the marriage of their daughter*

Michelle Emily

to

Jackson Charles Stanford

Saturday, the twenty-fourth of October

Two thousand twenty-six

at five o'clock

Reveille United Methodist Church

Richmond, Virginia

W-2023

PLEASE NOTE:

- Embassy invitations may require additional postage.

LOIRE SUITE • PRICE GROUP C

PAPER CODE	DESCRIPTION	WEIGHT
C9116GLD	EMBASSY GOLD BORDERED INVITATION	96#
W65	INSIDE ENVELOPE (ungummed)	32#
W85	OUTSIDE ENVELOPE	32#
LE9116	SINGLE ENVELOPE (not shown)	32#

DESIGN ELEMENTS

Lettering	ANGELINA ONE
Ink	NAVY
Process	THERMOGRAPHY
Lining	LIN445E Vintage Gold Floral (additional - price group HH)
Paper	ECRU KID FINISH®



PALOMA SUITE

PAPER CODE	DESCRIPTION	WEIGHT	PRICE GROUP
LC3322	BEACH GLASS EVENT CARD	96#	R
LE3111	ENVELOPE	32#	R
LE3322	BEACH GLASS ENVELOPE (not shown)	32#	R
V19-130	BEACH GLASS DETAILS CARD	96#	EE
LC1322	BEACH GLASS RESPONSE/RECEPTION CARD	96#	H
LE1111	PEARL WHITE RESPONSE ENVELOPE (not shown)	32#	H
LE1322	BEACH GLASS RESPONSE ENVELOPE (not shown)	32#	H

DESIGN ELEMENTS

- Lettering LONDON SCRIPT
SERLIO (block, shown all small caps with letter spacing added)
- Motifs MOT462A Seashell
MOT457A Sand Dollar
MOT1046A Two Pencil Starfish
- Ink GOLD
- Process ENGRAVING
- Lining LIN284B Gold Micro Stripe (additional - price group HH)
- Paper BEACH GLASS KID FINISH®
PEARL WHITE KID FINISH® (envelope)



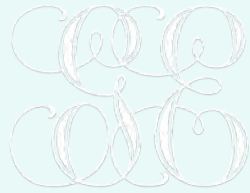

MR. AND MRS. GREGORY NELSON DOUGLAS
 INVITE YOU TO JOIN IN CELEBRATING
 THE MARRIAGE OF THEIR DAUGHTER

Georgia Courtney

TO

Eric Liam McDonough

SON OF MR. AND MRS. ALLEN MATTHEW MCDONOUGH
 SATURDAY, THE FIFTH OF SEPTEMBER
 TWO THOUSAND TWENTY-SIX
 AT THREE O'CLOCK IN THE AFTERNOON
 WYCHMERE BEACH CLUB
 23 SNOW INN ROAD
 HARWICH FORT, MASSACHUSETTS

Cocktails, dinner and dancing to follow

Mr. and Mrs. Gregory N. Douglas
 48 KNOLLWOOD ROAD
 MEDFIELD, MASSACHUSETTS 02052

PLEASE NOTE:

- Royalty invitations will require additional postage.
- Premium Weight papers are reserved for engraving and letterpress only.
- Double Envelopes are not available for colored papers.

PALOMA SUITE • PRICE GROUP L

PAPER CODE	DESCRIPTION	WEIGHT	DESIGN ELEMENTS
LCR0322	ROYALTY PREMIUM WEIGHT BEACH GLASS INVITATION (shown 2 color)	192#	Lettering SERLIO (block, shown all small caps with letter spacing added) LONDON SCRIPT
W13	INSIDE ENVELOPE (ungummed)	32#	Monogram MON439A
W33	OUTSIDE ENVELOPE	32#	Ink GOLD, WHITE
LE0111	SINGLE ENVELOPE (not shown)	32#	Process ENGRAVING
LE0322	BEACH GLASS SINGLE ENVELOPE (not shown)	32#	Lining LIN178B Gold Lustre (additional - price group HH)
			Paper BEACH GLASS KID FINISH® PEARL WHITE KID FINISH®

may thirtieth

PLEASE MARK YOUR CALENDAR
FOR THE WEDDING OF
KATHLEEN HILLENBRANDT AND BENJAMIN FISK
ASPEN, COLORADO
INVITATION TO FOLLOW

reception

FOLLOWING THE CEREMONY
THE LITTLE NELL
ASPEN, COLORADO

THE FAVOUR OF A REPLY IS REQUESTED
BY MAY TENTH
KATHANDBENWEDDING@EMAIL.COM

ASPEN SUITE

PAPER CODE	DESCRIPTION	WEIGHT	PRICE GROUP
LC1116	SAVE THE DATE CARD	96#	A
LE1116	SAVE THE DATE ENVELOPE (not shown)	32#	A
LC1116	RECEPTION/RESPONSE CARD	96#	A
LN1116	NOTE (shown 2 color)	32#	V
LE1116	NOTE ENVELOPE	32#	V

DESIGN ELEMENTS

Lettering	LA FIGURA (script, shown all lower case) FRANCO ROMAN (block)
Motif	MOT450A Four Trees
Inks	GOLD, MOSS GREEN
Process	ENGRAVING
Lining	LIN178B Gold Lustre (additional - price group HH)
Paper	ECRU KID FINISH®



TWENTY-SEVEN WEST PINES ROAD
ASPEN, COLORADO 81611



MR. AND MRS. JOHN BERNARD HILLENBRANDT

REQUEST THE HONOUR OF YOUR PRESENCE AT THE MARRIAGE OF THEIR DAUGHTER

Kathleen Susannah

TO

Benjamin Douglas Fisk

SATURDAY, MAY THIRTIETH, TWO THOUSAND TWENTY-SIX

AT SIX IN THE EVENING

THE ASPEN CHAPEL, ASPEN, COLORADO

ASPEN SUITE • PRICE GROUP A

PAPER CODE	DESCRIPTION	WEIGHT
LC9116	EMBASSY INVITATION (shown 2 color)	96#
W65	INSIDE ENVELOPE (ungummed)	32#
W85	OUTSIDE ENVELOPE	32#
LE9116	SINGLE ENVELOPE (not shown)	32#

DESIGN ELEMENTS

Lettering	LA FIGURA (script, shown all lower case)
	FRANCO ROMAN (block)
Motif	MOT450A Four Trees
Inks	GOLD, MOSS GREEN
Process	ENGRAVING
Lining	LIN200C Gold Leaves on Green (additional - price group HH)
Paper	ECRU KID FINISH®

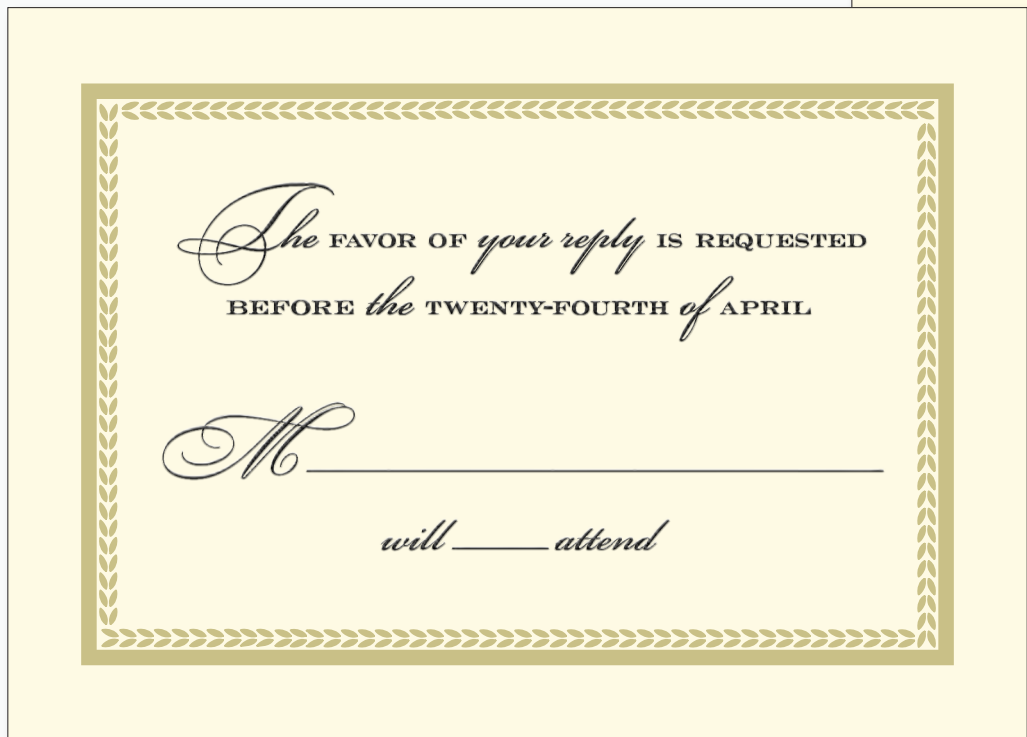

ACADIA SUITE • PRICE GROUP I

PAPER CODE	DESCRIPTION	WEIGHT
LC1106	TRAILING LEAVES RESPONSE CARD	96#
LE1116	RESPONSE ENVELOPE	32#
LC1106	TRAILING LEAVES RECEPTION CARD	96#

DESIGN ELEMENTS

Lettering	BICKHAM SWASH ENGRAVERS BOLD ROMAN (bold block) CORONET (block)
Motif	MOT1489A Leaf Duet
Ink	CHARCOAL
Process	ENGRAVING
Paper	ECRU KID FINISH®

1712 BROOKSIDE LANE
VIENNA, VIRGINIA 22182



MR. AND MRS. COLIN FREDERICK MITCHELL
REQUEST THE PLEASURE OF YOUR COMPANY
AT THE MARRIAGE OF THEIR DAUGHTER

Abigail Jordan

TO

Blake Richard Thompson

SATURDAY, THE SIXTEENTH OF MAY

TWO THOUSAND TWENTY-SIX

AT FIVE O'CLOCK

VIENNA PRESBYTERIAN CHURCH

VIENNA, VIRGINIA

PLEASE NOTE:

- Marquis Trailing Leaves invitations will require additional postage.

W-2023

ACADIA SUITE • PRICE GROUP I

PAPER CODE	DESCRIPTION	WEIGHT
LCM106	MARQUIS TRAILING LEAVES INVITATION	96#
LEM136	INSIDE ENVELOPE (ungummed)	32#
LEM146	OUTSIDE ENVELOPE	32#
LEM136G	SINGLE ENVELOPE (not shown)	32#

DESIGN ELEMENTS

Lettering	ENGRAVERS BOLD ROMAN (bold block), CORONET (block), BICKHAM SWASH
Monogram	MON532A
Inks	PLATINUM CHARCOAL
Process	ENGRAVING
Lining	LIN177B Silver Lustre (additional - price group HH)
Paper	ECRU KID FINISH®

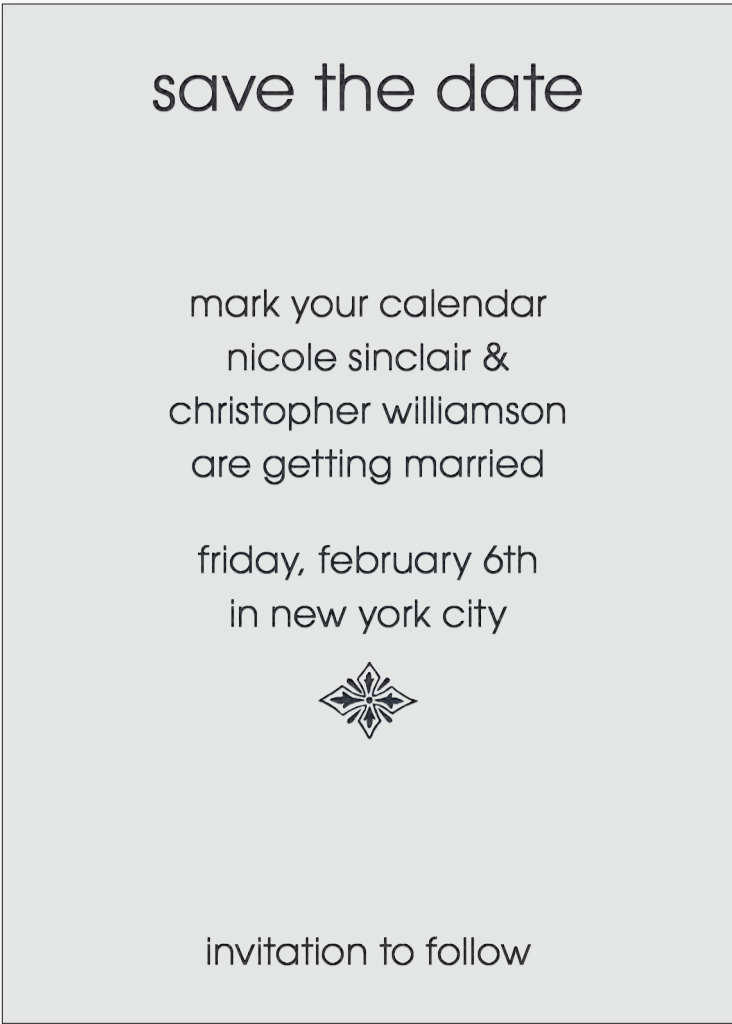

PLEASE NOTE:

- Above is an example of cards stacked together, revealing the top of each card.

SINCLAIR SUITE

PAPER CODE	DESCRIPTION	WEIGHT	PRICE GROUP
LC9322	EMBASSY BEACH GLASS INVITATION	96#	A
LC3123	LIGHT PINK RECEPTION CARD	110C	R
LC1112	LIGHT GRAY SAVE THE DATE CARD	110C	A
LE1112	LIGHT GRAY SAVE THE DATE ENVELOPE (not shown)	32W	A

DESIGN ELEMENTS

Lettering	AVANT GARDE PRO BOOK (shown all lower case)
Motifs	MOT174A Wine & Cheese (on reception card) MOT522A Dingbat (on save the date)
Ink	CHARCOAL
Process	ENGRAVING
Paper	BEACH GLASS KID FINISH® LIGHT PINK LETTRA IMPRESS LIGHT GRAY LETTRA IMPRESS

PLEASE NOTE:

- Embassy invitations may require additional postage.
- Double Envelopes are not available for colored papers.

2 west 49th street, apt. 3n
new york, new york 10021

ceremony

please join us
as we unite in marriage

friday, february 6th
two thousand twenty-six
four o'clock in the afternoon

first presbyterian church
12 west 12th street
new york, new york

nicole sinclair & christopher williamson

please reply

let us know
by january 12th

if you'll be joining us
nic&chriswedd@email.com



looking forward to seeing you

SINCLAIR SUITE • PRICE GROUP A

PAPER CODE	DESCRIPTION	WEIGHT
LC9322	EMBASSY BEACH GLASS INVITATION	96#
LE9123	LIGHT PINK SINGLE ENVELOPE	32W
LE9322	BEACH GLASS SINGLE ENVELOPE (not shown)	32#
LC1112	LIGHT GRAY RESPONSE CARD	110C

DESIGN ELEMENTS

Lettering	AVANT GARDE PRO BOOK (shown all lower case)
Motif	MOT026A Fleur de Lis Large
Ink	CHARCOAL
Process	ENGRAVING
Paper	BEACH GLASS KID FINISH® LIGHT PINK LETTRA IMPRESS LIGHT GRAY LETTRA IMPRESS

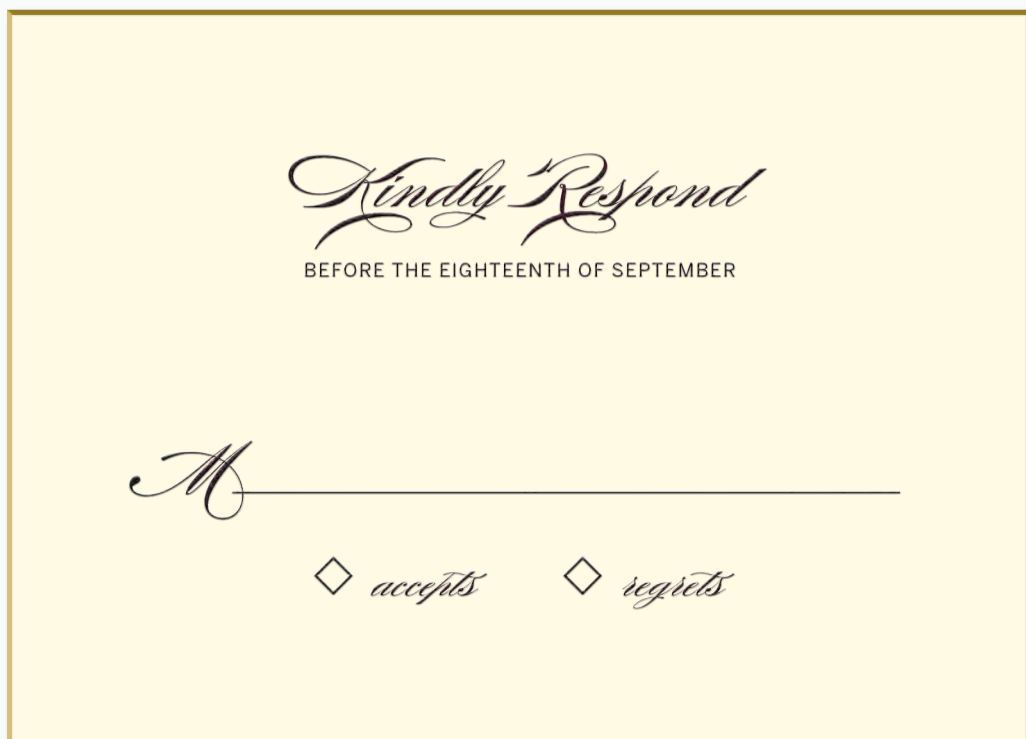

VIENNA SUITE

PAPER CODE	DESCRIPTION	WEIGHT	PRICE GROUP
GB1116	GOLD BEVEL RESPONSE/RECEPTION CARD	96#	J
LE1116	RESPONSE ENVELOPE (not shown)	32#	J
F1116GLD	GOLD BORDERED HEAVYWEIGHT NOTE	64#	X
LE1116	NOTE ENVELOPE	32#	X

DESIGN ELEMENTS

Lettering	BURGUES SCRIPT, BENTON REGULAR (block)
Motifs	MOT1515A Small Diamond MOT269B Ornament
Inks	KONA GOLD
Process	ENGRAVING
Lining	LIN443E Metallic Gold (additional - price group HH)
Paper	ECRU KID FINISH®



5700 SEAWALK DRIVE, APARTMENT FIVE
PLAYA VISTA, CALIFORNIA 90094

PLEASE NOTE:
• Royalty invitations will require additional postage.

VIENNA SUITE • PRICE GROUP J

PAPER CODE	DESCRIPTION	WEIGHT
LC0116	ROYALTY GOLD BEVEL INVITATION (shown 2 color)	96#
W17	INSIDE ENVELOPE (ungummed)	32#
W37	OUTSIDE ENVELOPE	32#
LE0116	SINGLE ENVELOPE (not shown)	32#

DESIGN ELEMENTS

Lettering	BURGUES SCRIPT, BENTON REGULAR (block)
Motif	MOT269B Ornament
Inks	GOLD
	KONA
Process	ENGRAVING
Lining	LIN382S Golden Swirl (additional - price group HH)
Paper	ECRU KID FINISH®

*Mr. and Mrs. Ethan Stephen Morneau
request the honour of your presence
at the marriage of their daughter*

Elena Shannon

to

Doctor Sean Joseph Morley, III

Saturday, the seventh of March

two thousand twenty-six

at six o'clock in the evening

First Presbyterian Church

100 School Street

Greer, South Carolina

At Home

after the twenty-seventh of March

3284 Cottonwood Drive

Aiken, South Carolina 29803

WINCHESTER SUITE

PAPER CODE	DESCRIPTION	WEIGHT	PRICE GROUP
LF9116	EMBASSY INVITATION	64#	E
V31-130	AT HOME CARD	96#	EE
LC1116	RECEPTION/RESPONSE CARD	96#	E
LE1116	RESPONSE ENVELOPE (not shown)	32#	E

DESIGN ELEMENTS

Lettering	SHELLEY ALLEGRO
Ink	BLACK
Processes	THERMOGRAPHY, FLAT (invite inside)
Paper	ECRU KID FINISH®

Reception to follow

Poinsett Club

807 East Washington Street

Greenville, South Carolina

The favour of a reply is requested

204 Antigua Way

Greer, South Carolina 29650

*204 Antigua Way
Greer, South Carolina 29650*

EMS

PLEASE NOTE:

- Embassy folders may require additional postage.

W-2023

WINCHESTER SUITE • PRICE GROUP E

PAPER CODE	DESCRIPTION	WEIGHT
LF9116	EMBASSY INVITATION	64#
W65	INSIDE ENVELOPE (ungummed)	32#
W85	OUTSIDE ENVELOPE	32#
LE9116	SINGLE ENVELOPE (not shown)	32#

DESIGN ELEMENTS

Lettering	SHELLEY ALLEGRO
Monogram	MON200D
Inks	GOLD
	BLACK
Process	THERMOGRAPHY
Lining	LIN099D Linen Gold (additional - price group HH)
Paper	ECRU KID FINISH®

Accommodations

A block of rooms has been reserved at the following hotels.
Please refer to the Flynn/Wainwright wedding when making
reservations to receive the special rate.

THE ST. REGIS
www.stregisnewyork.com 888-627-7103

THE RITZ-CARLTON
www.ritzcarlton.com/New-York 800-542-8680

Please make your reservations prior to September 4th.

Visit us at

flynnwainwrightwed.com for additional details

Kindly respond

BY THE TWENTY-FIRST OF SEPTEMBER

SIENA SUITE

PAPER CODE	DESCRIPTION	WEIGHT	PRICE GROUP
LC3116	ACCOMMODATIONS CARD	96#	R
LC1116	RESPONSE/RECEPTION CARD	96#	H
LE1116	RESPONSE ENVELOPE (not shown)	32#	H
LF1116	HEAVYWEIGHT NOTE	64#	W
LE1116	NOTE ENVELOPE	32#	W

DESIGN ELEMENTS

Lettering	NEW BASKERVILLE (block), MOZART (script)
Motif	MOT1311A Branch
Inks	CHARCOAL GOLD
Process	ENGRAVING
Lining	LIN490E Grey and Gold Marble (additional - price group HH)
Paper	ECRU KID FINISH®

Elizabeth Wainwright



MR. AND MRS. CHARLES KENNETH FLYNN
34 Beechwood Boulevard
Rye Brook, New York 10573

MR. AND MRS. CHARLES KENNETH FLYNN
request the pleasure of your company at the marriage of their daughter

Elizabeth Sarah
to
Matthew Darren Wainwright

SATURDAY, THE SEVENTEENTH OF OCTOBER

Two thousand twenty-six
at six o'clock in the evening

THE ST. REGIS
New York, New York

Reception to follow

PLEASE NOTE:

- Royalty invitations will require additional postage.

SIENA SUITE • PRICE GROUP H

PAPER CODE	DESCRIPTION	WEIGHT
LC0106	ROYALTY INVITATION (shown 2 color)	96#
W17	INSIDE ENVELOPE (ungummed)	32#
W37	OUTSIDE ENVELOPE	32#
LE0116	SINGLE ENVELOPE (not shown)	32#

DESIGN ELEMENTS

Lettering	NEW BASKERVILLE (block)
	MOZART (script)
Motif	MOT1509A Reception to Follow
Inks	CHARCOAL, GOLD
Process	ENGRAVING
Lining	LIN469C Damask Cream (additional - price group HH)
Paper	ECRU KID FINISH®

The favour of a reply is requested

BY THE ELEVENTH OF APRIL

M _____

WILL _____ ATTEND

Cocktails, dinner and dancing

FOLLOWING THE CEREMONY

at

THREE O'CLOCK IN THE EVENING

Woodbury Country Club

540 HOYS STREET

DARIEN, CONNECTICUT



WHITNEY SUITE

PAPER CODE	DESCRIPTION	WEIGHT	PRICE GROUP
LC1111	RESPONSE CARD	96#	H
LE1111	RESPONSE ENVELOPE (not shown)	32#	L
LC1661	PREMIUM WEIGHT RECEPTION CARD	192#	L
F1111GLD	GOLD BORDERED HEAVYWEIGHT NOTE	64#	X
LE1111	NOTE ENVELOPE	32#	X

DESIGN ELEMENTS

Lettering	BICKHAM SCRIPT
	FUTURA BOOK (block)
Monogram	MON307A
Ink Edge	PEWTER (on response and reception cards)
Ink	PEWTER
Process	ENGRAVING
Lining	LIN177B Silver Lustre (additional - price group HH)
Paper	PEARL WHITE KID FINISH®

PLEASE NOTE:

- For painted edge treatments shown, orders need to indicate color choice and will require additional delivery time.



Mr. and Mrs. Thomas Joseph Anderson

REQUEST THE HONOUR OF YOUR PRESENCE
AT THE MARRIAGE OF THEIR DAUGHTER

Stephanie Roberta

to

Mr. Richard Wylie Albert, junior

SATURDAY, THE SECOND OF MAY
TWO THOUSAND TWENTY-SIX
at
ONE O'CLOCK IN THE AFTERNOON

Saint Morysius Church

NEW CANAAN, CONNECTICUT

*Tom Blueberry Lane
South Salem, New York 10590*

PLEASE NOTE:

- Royalty invitations will require additional postage.
- For the painted edge treatment shown, orders need to indicate color choice and will require additional delivery time.

W-2023

WHITNEY SUITE • PRICE GROUP L

PAPER CODE	DESCRIPTION	WEIGHT
LCR0161	ROYALTY PREMIUM WEIGHT INVITATION (shown 2 color)	192#
W13	INSIDE ENVELOPE (ungummed)	32#
W33	OUTSIDE ENVELOPE	32#
LE0111	SINGLE ENVELOPE (not shown)	32#

DESIGN ELEMENTS

Lettering	BICKHAM SCRIPT, FUTURA BOOK (block)
Monogram	MON307B
Ink Edge	PEWTER
Inks	PEWTER, GOLD
Process	ENGRAVING
Lining	LIN123D White Moire Fabric (additional - price group HH)
Paper	PEARL WHITE KID FINISH®

SYDNEY AND SHANE
THE HISTORIC ATLAS THEATRE - MAY 9TH, 2026

FIRST COURSE

ROASTED HEIRLOOM BEETS
WITH GOAT CHEESE AND TOASTED HAZELNUTS
AND CITRUS SHALLOT VINAIGRETTE

ENTRÉE

CUMIN RUBBED LAMB LOIN
WITH ROASTED DELICATA SQUASH
AND A SOUR CHERRY SAUCE

- OR -

GRILLED FILET MIGNON
WITH CONFIT HEIRLOOM TOMATOES
SAUTÉED SPINACH AND PARMESAN TUILE

DESSERT

WEDDING CAKE AND MINIATURE PECAN PIES
COFFEE AND TEA

DECO SUITE

PAPER CODE	DESCRIPTION	WEIGHT	PRICE GROUP
LC3116	MENU CARD	96#	R
LC1556	EMBOSSED FRAME SAVE THE DATE CARD	96#	D
LE1116	SAVE THE DATE ENVELOPE	32#	D
T84-124	PLACE CARD	64#	EE

DESIGN ELEMENTS

Lettering	CORONET
Ink	CHARCOAL
Process	ENGRAVING
Paper	ECRU KID FINISH®

9115 WILDFLOWER DRIVE
CHEYENNE, WYOMING 82009

SYDNEY AND SHANE

MAY 9, 2026

PLEASE SAVE THE DATE FOR THE WEDDING OF

SYDNEY FRANCIS

AND

SHANE BANKS

CHEYENNE, WYOMING

FORMAL INVITATION TO FOLLOW



DECO SUITE • PRICE GROUP D

PAPER CODE	DESCRIPTION	WEIGHT
LC9556	EMBASSY EMBOSSED FRAME INVITATION	96#
W65	INSIDE ENVELOPE	32#
W85	OUTSIDE ENVELOPE	32#
LE9116	SINGLE ENVELOPE (not shown)	32#
LC1556	EMBOSSED FRAME RESPONSE CARD	96#
LE1116	RESPONSE ENVELOPE (not shown)	32#

DESIGN ELEMENTS

Lettering	CORONET
Ink	CHARCOAL
Process	ENGRAVING
Lining	LIN377B Gold Stripes (additional - price group HH)
Paper	ECRU KID FINISH®





Together with their families

**CRYSTAL BROOKE
LANGEVIN**

and

**ANTONIO RENE
PALACIO**

REQUEST THE PLEASURE OF YOUR COMPANY
AT THEIR WEDDING
SATURDAY, THE FIFTH OF DECEMBER
TWO THOUSAND TWENTY-SIX
AT FIVE O'CLOCK IN THE AFTERNOON

NORTH BEACH
THE RITZ-CARLTON
NAPLES, FLORIDA

DINNER AND DANCING TO FOLLOW

A SPECIAL ROOM RATE HAS BEEN RESERVED
FOR THE LANGEVIN / PALACIO WEDDING CELEBRATION
PLEASE CALL (877) 590-5187 PRIOR TO 11/06/26

PLEASE JOIN US FRIDAY NIGHT FOR COCKTAILS AND DINNER
THE DUSK RESTAURANT AT SEVEN O'CLOCK



KINDLY R.S.V.P. BEFORE NOVEMBER TWENTIETH
VIA CRYSTALANDANTONIOWED.COM

LAGUNA SUITE • PRICE GROUP A

PAPER CODE	DESCRIPTION	WEIGHT
LC9322	EMBASSY INVITATION	96#
LE9322	SINGLE ENVELOPE	32#
LC1322	RESPONSE/RECEPTION CARD	96#
LE1322	RESPONSE ENVELOPE (not shown)	32#

DESIGN ELEMENTS

Lettering	CITADEL SCRIPT, SHADED ROMAN (shaded block), SERLIO (block)
Motifs	MOT178B Palm Tree MOT455A Sea Grass
Ink	TAUPE
Process	LETTERPRESS
Lining	LIN278B Champagne Shimmer (additional - price group HH)
Paper	BEACH GLASS KID FINISH®

PLEASE NOTE:

- Embassy invitations may require additional postage.
- Double Envelopes are not available for colored papers.

W-2023

PLEASE NOTE:

- Royalty invitations will require additional postage.

MR. AND MRS. EDWARD RAYMOND HENDERSON
 REQUEST THE PLEASURE OF YOUR COMPANY
 AT THE MARRIAGE OF THEIR DAUGHTER

Rachel Annabelle

TO

Nathaniel Drew Bentley

SATURDAY, THE THIRTY-FIRST OF OCTOBER
 TWO THOUSAND TWENTY-SIX
 AT HALF AFTER SIX O’CLOCK IN THE EVENING

Rosewood Mayakoba

RIVIERA MAYA | QUINTANA ROO

MEXICO



Reception to follow

BIANCA SUITE • PRICE GROUP H

PAPER CODE	DESCRIPTION	WEIGHT
LC0101	ROYALTY INVITATION	96#
W13	INSIDE ENVELOPE (ungummed, not shown)	32#
W33	OUTSIDE ENVELOPE (not shown)	32#
LE0111	SINGLE ENVELOPE	32#
LC1111	RESPONSE/RECEPTION CARD	96#
LE1111	RESPONSE ENVELOPE (not shown)	32#

DESIGN ELEMENTS

Lettering	NEW BASKERVILLE (block, shown all upper case with letter spacing added)
	LONDON SCRIPT
Motif	MOT780A Printer’s Ornament
Frame	FRA030
Ink	POLISHED COPPER
Process	ENGRAVING
Lining	LIN277B Pearl Shimmer (additional - price group HH)
Paper	PEARL WHITE KID FINISH®

Kindly reply by
 THE NINTH OF OCTOBER

M _____

_____ JOYFULLY ACCEPT

_____ REGRETFULLY DECLINE

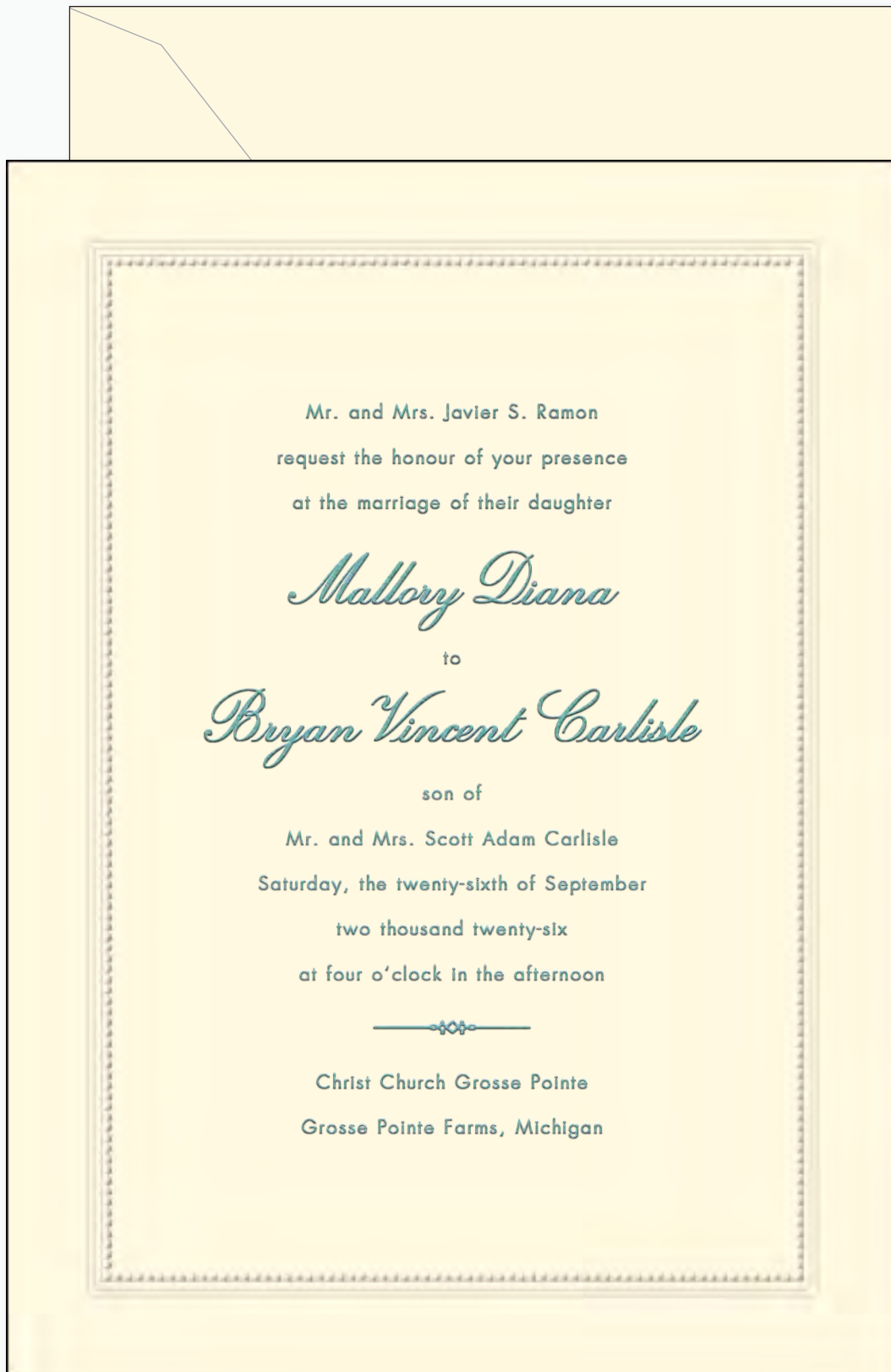

PLEASE NOTE:
 • Embassy invitations may require additional postage.

CARLISLE SUITE • PRICE GROUP D

PAPER CODE	DESCRIPTION	WEIGHT
LC9986	BEADED FRAME INVITATION	96#
W65	INSIDE ENVELOPE (ungummed, not shown)	32#
W85	OUTSIDE ENVELOPE (not shown)	32#
LE9116	SINGLE ENVELOPE	32#
LC1986	BEADED FRAME RESPONSE/ RECEPTION CARD	96#
LE1116	RESPONSE ENVELOPE (not shown)	32#

DESIGN ELEMENTS

Lettering	FUTURA LIGHT (block), LONDON SCRIPT
Motif	MOT1004A Line Knot
Ink	PEACOCK
Process	ENGRAVING
Lining	LIN278B Champagne Shimmer (additional - price group HH)
Paper	ECRU KID FINISH®



PLEASE NOTE:

- Royalty invitations will require additional postage.
- Premium Weight Lettra papers are reserved for engraving and letterpress only.

*Mr. and Mrs. Leonard Charles Ashton
request the pleasure of your company
at the marriage of their daughter*

Emma Jayne

to

Daniel Stephen Rochester

Saturday, the twenty-fifth of April

Two thousand twenty-six

at four o'clock in the afternoon

The Brass on Baltimore

Kansas City, Missouri

Reception to follow

*4940 Summit Street
Kansas City, Missouri 64119*

*The favour of a reply is requested
before the third of April*

M _____

will _____ attend

KESWICK SUITE • PRICE GROUP L

PAPER CODE	DESCRIPTION	WEIGHT
LCR0261	ROYALTY PREMIUM WEIGHT INVITATION	220#
W54	INSIDE ENVELOPE (ungummed)	32#
W55	OUTSIDE ENVELOPE	32#
LE0721	SINGLE ENVELOPE (not shown)	32#
LC1901	PREMIUM WEIGHT RESPONSE/RECEPTION CARD	220#
LE1721	RESPONSE ENVELOPE (not shown)	32#

DESIGN ELEMENTS

Lettering	MOZART
Motifs	MOT1521A Reception to follow MOT1516A The favour of a reply is requested
Ink	GOLD
Process	ENGRAVING
Lining	LIN284B Gold Micro Stripe (additional - price group HH)
Paper	PEARL WHITE LETTRA®

CJS

Mr. and Mrs. Nathan Charles Wright
request the pleasure of your company
at the marriage of their daughter

CARLY NICOLE

to

SAMUEL PHILLIP JONES

Saturday, the eighteenth of July
two thousand twenty-six
at one o'clock in the afternoon

THE POLO BARN AT SAXONY FARM
Lexington, Kentucky

Dinner and dancing to follow

PLEASE NOTE:

- Embassy invitations may require additional postage.

CJS

Accommodations

Hilton/Lexington Downtown
369 West Vine Street
859-231-9000

A block of rooms
has been reserved under
the Wright/Jones Wedding

R.S.V.P.

before the third of July via our website:

WWW.CARLYANDSAM.COM

OXFORD SUITE • PRICE GROUP A

PAPER CODE	DESCRIPTION	WEIGHT
LC9826	EMBASSY INVITATION (shown 2 color)	110#
W95	INSIDE ENVELOPE (ungummed, not shown)	32#
W96	OUTSIDE ENVELOPE (not shown)	32#
LE9326	SINGLE ENVELOPE	32#
LC1026	ACCOMMODATION CARD	110#
LC1026	RESPONSE/RECEPTION CARD (not shown)	110#
LE1326	RESPONSE ENVELOPE (not shown)	32#

DESIGN ELEMENTS

Lettering	FUTURA LIGHT (block) LIGHT FRENCH ROMAN (small cap block) NEW BASKERVILLE ITALIC ITC PRO (italic)
Monogram	MON414A
Frame	FRA012
Inks	RASPBERRY, PEWTER
Process	LETTERPRESS
Lining	LIN058A Raspberry (additional - price group HH)
Paper	ECRU LETTRA®

PLEASE NOTE:

- Royalty invitations will require additional postage.
- Premium Weight Letra papers are reserved for engraving and letterpress only.

LRM

Together with their families

the pleasure of your company is requested at the marriage of

Lindsay Hopkins and Morgan Raab

Sunday, the twenty-seventh of September
two thousand twenty-six
at five o'clock in the afternoon

The Rainier Club
820 4th Avenue
Seattle, Washington



Reception immediately following

RSVP

before the fourth of September

M _____

_____ will attend

_____ will not attend

VERONA SUITE • PRICE GROUP L

PAPER CODE	DESCRIPTION	WEIGHT
LCR0266	ROYALTY PREMIUM WEIGHT INVITATION (shown 2 color)	220#
W57	INSIDE ENVELOPE (ungummed, not shown)	32#
W59	OUTSIDE ENVELOPE (not shown)	32#
LE0726	SINGLE ENVELOPE	32#
LC1906	PREMIUM WEIGHT RESPONSE/RECEPTION CARD (shown 2 color)	220#
LE1326	RESPONSE ENVELOPE (not shown)	32#

DESIGN ELEMENTS

Lettering	NEW BASKERVILLE (block), FEEL SCRIPT
Monogram	M451
Motifs	MOT1317A Flourish, MOT1327A RSVP
Inks	TAUPE, BLIND DEBOSS (reserved for letterpress only)
Process	LETTERPRESS
Lining	LIN469C Damask Cream (additional - price group HH)
Paper	ECRU LETTRA®



TOGETHER WITH THEIR FAMILIES

RILEY DEVIN NICHOLS

and

BENJAMIN JACOB SIMMONS

REQUEST THE PLEASURE OF YOUR COMPANY
AT THE CELEBRATION OF THEIR MARRIAGE
SATURDAY, THE TWENTY-SECOND OF AUGUST
AT SIX O'CLOCK IN THE EVENING

RITTENHOUSE HOTEL

PHILADELPHIA

Dinner and dancing to follow

PLEASE NOTE:

- Embassy invitations may require additional postage.

REVERE SUITE • PRICE GROUP C

PAPER CODE	DESCRIPTION	WEIGHT
C9111PLT	EMBASSY PLATINUM BORDERED INVITATION	96#
W60	INSIDE ENVELOPE (ungummed, not shown)	32#
W80	OUTSIDE ENVELOPE (not shown)	32#
LE9111	SINGLE ENVELOPE	32#
C1111PLT	PLATINUM BORDERED RESPONSE/RECEPTION CARD	96#
LE1111	RESPONSE ENVELOPE (not shown)	32#

DESIGN ELEMENTS

Lettering	CORONET (block), ROYAL SCRIPT
Monogram	MON557C
Motifs	MOT1512A Small Line MOT1513A RSVP with Small Line
Ink	CHARCOAL
Process	THERMOGRAPHY
Lining	LIN177B Silver Lustre (additional - price group HH)
Paper	PEARL WHITE KID FINISH®

R S V P

before the thirty-first of July

PLEASE NOTE:

- Royalty Pearl Frame invitations will require additional postage.
- See Hebrew page for alternate Hebrew phrase motifs.

ב"ה

*Mr. and Mrs. Thomas Aaron Smith
Mr. and Mrs. Robert Jason Kassin
request the honour of your presence
at the marriage uniting their children*

*Amanda
and
Joshua*

*Sunday, the seventeenth of January
two thousand twenty-six
at five o'clock in the afternoon
Sixth and Historic Synagogue
600 I Street, N.W.
Washington, District of Columbia*

2198 NORTH VEITCH STREET #110
ARLINGTON, VIRGINIA 22201

W-2023

*Please join us in celebration
immediately following the ceremony
Sequoia at Washington Harbour
3000 I Street N.W.
Washington, District of Columbia*

LANCASTER SUITE • PRICE GROUP I

PAPER CODE	DESCRIPTION	WEIGHT
LC0141	ROYALTY PEARL FRAME INVITATION	96#
W13	INSIDE ENVELOPE (ungummed)	32#
W33	OUTSIDE ENVELOPE	32#
LE0111	SINGLE ENVELOPE (not shown)	32#
LC1141	PEARL FRAME RESPONSE/RECEPTION CARD	96#
LE1111	RESPONSE ENVELOPE (not shown)	32#

DESIGN ELEMENTS

Lettering	BURGUES SCRIPT, BENTON REGULAR (block on envelope)
Motif	MOT1123A Bays Hay
Inks	NAVY, BLIND EMBOSS
Processes	ENGRAVING, BLIND EMBOSSING
Lining	LIN131A Navy (additional - price group HH)
Paper	PEARL WHITE KID FINISH®

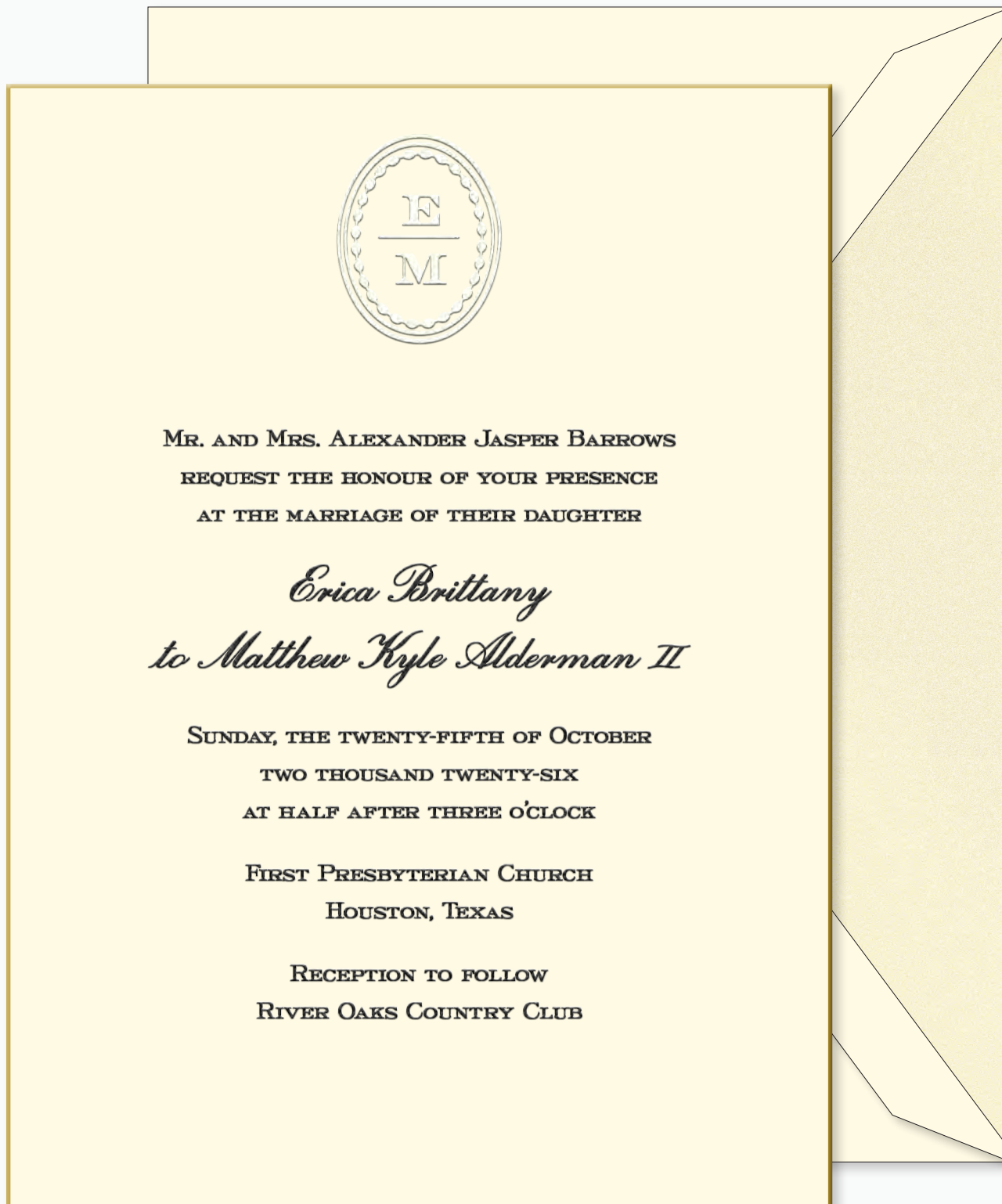

CHELSEA SUITE

PAPER CODE	DESCRIPTION	WEIGHT	PRICE GROUP
GB9116	EMBASSY GOLD BEVEL INVITATION (shown 2 color)	96#	B
GB9206	EMBASSY PREMIUM WEIGHT GOLD BEVEL INVITATION (not shown)	192#	G
W65	INSIDE ENVELOPE (ungummed, not shown)	32#	B
W85	OUTSIDE ENVELOPE (not shown)	32#	B
LE9116	SINGLE ENVELOPE	32#	B
GB1116	GOLD BEVEL RESPONSE/RECEPTION CARD (shown 2 color)	96#	B
GB1206	PREMIUM WEIGHT GOLD BEVEL RESPONSE/RECEPTION CARD (not shown)	192#	G
LE1116	RESPONSE ENVELOPE (not shown)	32#	B

DESIGN ELEMENTS

Lettering	LIGHT FRENCH ROMAN (block) ROYAL SCRIPT
Monogram	MON512A
Inks	CHARCOAL, BLIND EMBOSS
Processes	THERMOGRAPHY, BLIND EMBOSSING
Lining	LIN278B Champagne Shimmer (additional - price group HH)
Paper	ECRU KID FINISH®

PLEASE NOTE:

- Embassy invitations may require additional postage.

PLEASE NOTE:

- Embassy invitations may require additional postage.

MR. AND MRS. PARKER JAMES TURNER

REQUEST THE PLEASURE OF YOUR COMPANY

AT THE MARRIAGE OF THEIR DAUGHTER

Julia Alyssa

TO

Colin Robert Lachman

SATURDAY, THE TWENTY-FOURTH OF JANUARY

TWO THOUSAND TWENTY-SIX

AT HALF AFTER SIX O'CLOCK IN THE EVENING

The Manor House

7440 SOUTH MASON MONTGOMERY ROAD

MASON, OHIO

Cocktails, Dinner and Dancing

IMMEDIATELY FOLLOWING THE CEREMONY

R.S.V.P.

BY JANUARY 2, 2026

M _____

_____ **WOULDN'T MISS IT FOR THE WORLD**

_____ **NUMBER ATTENDING**

_____ **WILL BE THERE IN SPIRIT**

JULIA SUITE • PRICE GROUP A

PAPER CODE	DESCRIPTION	WEIGHT
LC9116	EMBASSY INVITATION	96#
W65	INSIDE ENVELOPE (ungummed, not shown)	32#
W85	OUTSIDE ENVELOPE (not shown)	32#
LE9116	SINGLE ENVELOPE	32#
LC1116	RESPONSE/RECEPTION CARD	96#
LE1116	RESPONSE ENVELOPE (not shown)	32#

DESIGN ELEMENTS

Lettering	ENGRAVERS BOLD ROMAN (block) BURGUES SCRIPT
Ink	BLACK
Process	THERMOGRAPHY
Lining	LIN468C Gold Damask on Black (additional - price group HH)
Paper	ECRU KID FINISH®



PLEASE NOTE:

- Embassy invitations may require additional postage.
- Lettra papers are reserved for engraving or letterpress only.

HAYWORTH SUITE • PRICE GROUP D

PAPER CODE	DESCRIPTION	WEIGHT
LC9781	EMBASSY ELEGANT FRAME INVITATION	110#
W90	INSIDE ENVELOPE (ungummed, not shown)	32#
W91	OUTSIDE ENVELOPE (not shown)	32#
LE9821	SINGLE ENVELOPE	32#
LC1781	ELEGANT FRAME RESPONSE/RECEPTION CARD	110#
LE1721	RESPONSE ENVELOPE (not shown)	32#

DESIGN ELEMENTS

Lettering	CORONET (block) MOZART (script)
Motif	MOT1409A Small Calligraphic Swash
Ink	CHARCOAL
Process	LETTERPRESS
Lining	LIN178B Gold Lustre (additional - price group HH)
Paper	PEARL WHITE LETTRA®





PLEASE NOTE:
• Marquis cards will require additional postage.

PRESTON SUITE • PRICE GROUP H

PAPER CODE	DESCRIPTION	WEIGHT
LCM111	MARQUIS INVITATION (shown 2 color)	96#
LEM131	INSIDE ENVELOPE (ungummed, not shown)	32#
LEM141	OUTSIDE ENVELOPE (not shown)	32#
LEM131G	SINGLE ENVELOPE	32#
LC1111	RESPONSE/RECEPTION CARD	96#
LE1111	RESPONSE ENVELOPE (not shown)	32#

DESIGN ELEMENTS

Lettering	SERLIO (block, shown in small caps with letter spacing added) BICKHAM SCRIPT
Motifs	MOT1086D Ornamental Triangle MOT1518A Reception immediately following the ceremony MOT1520A Floral Shape (on reply)
Inks	BLACK PLATINUM
Process	ENGRAVING
Lining	LIN135A Black (additional - price group HH)
Paper	PEARL WHITE KID FINISH®



*Mr. and Mrs. Nicholas Chase Anderson
request the pleasure of your company
at the marriage of their daughter*

Bethany Grace

to

Mr. Colin Thomas Lawson

*Saturday, the eighteenth of April
two thousand twenty-six
at five o'clock*

Canoe

*4199 Duces Ferry Road Southeast
Atlanta, Georgia*

Reception to follow



PLEASE NOTE:

- Embassy invitations may require additional postage.
- Premium Weight papers are reserved for engraving or letterpress only.
- For painted edge treatments shown, orders need to indicate color choice and will require additional delivery time.

TIVOLI SUITE • PRICE GROUP F

PAPER CODE	DESCRIPTION	WEIGHT
LC9666	EMBASSY PREMIUM WEIGHT INVITATION	192#
W65	INSIDE ENVELOPE (ungummed, not shown)	32#
W85	OUTSIDE ENVELOPE (not shown)	32#
LE9116	SINGLE ENVELOPE	32#
LC1666	PREMIUM WEIGHT RESPONSE/RECEPTION CARD	192#
LE1116	RESPONSE ENVELOPE (not shown)	32#

DESIGN ELEMENTS

Lettering	BICKHAM SCRIPT BICKHAM SWASH
Ink Edge	CLEMENTINE
Ink	GOLD
Process	ENGRAVING
Lining	LIN309C Red Florentine (additional - price group HH)
Paper	ECRU KID FINISH®

*The favor of a reply is requested
before the twenty-seventh of March*

M _____

_____ *will attend*

_____ *will not attend*

_____ *number attending*



*José Hernández Caratini
Carmen María de Hernández*

y

*Juan Martínez Sarza
Consuelo Elena de Mercado*
*tienen el honor de invitarle
al matrimonio de sus hijos*

Sophía

y

Joaquín

*el sábado, veintuno de marzo
dos mil veintiois
a las dos de la tarde
Santa Iglesia Catedral
San Juan de Puerto Rico*

*José Hernández Caratini
Carmen María de Hernández*

and

*Juan Martínez Sarza
Consuelo Elena de Mercado*
*request the honour of your presence
at the marriage uniting their children*

Sophía Hernández

and

Joaquín Mercado

*Saturday, the twenty-first of March
two thousand twenty-six
at two o'clock in the afternoon
Santa Iglesia Cathedral
San Juan, Puerto Rico*

INSIDE FOLDER

PLEASE NOTE:

- Royalty folders will require additional postage.



*Por favor, responda antes del veinte de febrero
Kindly respond by the twentieth of February*

CHESHIRE SUITE • PRICE GROUP K

PAPER CODE	DESCRIPTION	WEIGHT
LF0111	ROYALTY INVITATION	64#
W13	INSIDE ENVELOPE (ungummed, not shown)	32#
W33	OUTSIDE ENVELOPE (not shown)	32#
LE0111	SINGLE ENVELOPE	32#
LC1111	RESPONSE/RECEPTION CARD (shown 2 color)	96#
LE1111	RESPONSE ENVELOPE (not shown)	32#

DESIGN ELEMENTS

Lettering	STUYVESANT SCRIPT
Monograms	MON439D (on invite) MON439C (on reply)
Inks	GOLD, CHARCOAL
Processes	THERMOGRAPHY
Lining	FLAT (invite inside)
Paper	LIN178B Gold Lustre (additional - price group HH) PEARL WHITE KID FINISH®



GOLD BEVEL KENT CARD

PAPER CODE	DESCRIPTION	WEIGHT	PRICE GROUP
GB3116	GOLD BEVEL MENU CARD	96#	S
GB3111	PEARL WHITE GOLD BEVEL MENU CARD (not shown)	96#	S
GB3206	ECRU PREMIUM WEIGHT GOLD BEVEL MENU CARD (not shown)	192#	T
GB3201	PEARL WHITE PREMIUM WEIGHT GOLD BEVEL MENU CARD (not shown)	192#	T

DESIGN ELEMENTS

Lettering	SERLIO (block, shown all small caps with letter spacing added) BURGUES SCRIPT
Motifs	MOT1110A Menu MOT1404B Sweeping Flourish
Ink	GOLD
Process	ENGRAVING
Paper	ECRU KID FINISH®

MONARCH CARD • PRICE GROUP P

PAPER CODE	DESCRIPTION	WEIGHT
LC7116	ECRU MENU CARD	96#
LC7111	PEARL WHITE MENU CARD (not shown)	96#

DESIGN ELEMENTS

Lettering	FUTURA BOOK (block) MOZART (script)
Monogram	MON529B
Motifs	MOT1525A Salad MOT1526A Entrées MOT1527A Dessert
Ink	TAUPE
Process	ENGRAVING
Paper	ECRU KID FINISH®



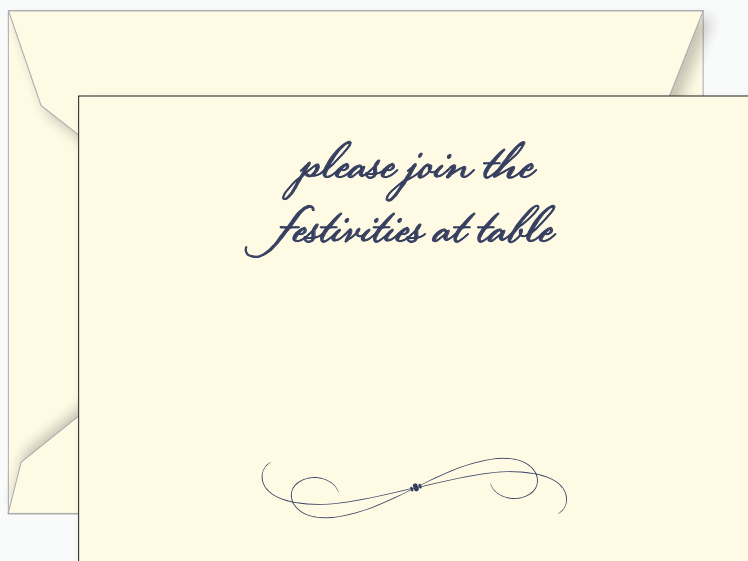

PAPER CODE	DESCRIPTION	WEIGHT	PRICE GROUP
V31-130	ECRU TABLE CARD	96#	EE
E82-130	TABLE CARD ENVELOPE	32#	EE

DESIGN ELEMENTS

Lettering	ANGELINA ONE
Motif	MOT1404A Sweeping Flourish
Ink	NAVY
Process	THERMOGRAPHY
Paper	ECRU KID FINISH®

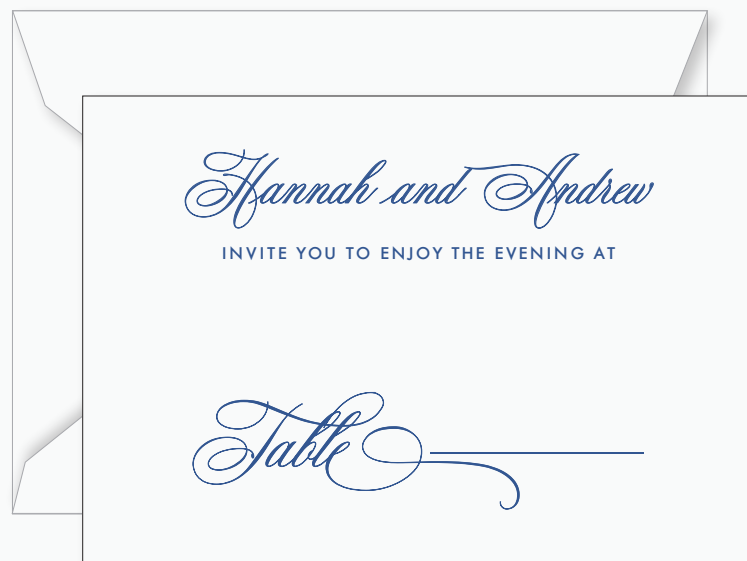

PAPER CODE	DESCRIPTION	WEIGHT	PRICE GROUP
V30-130	PEARL WHITE TABLE CARD	96#	EE
E91-130	TABLE CARD ENVELOPE	32#	EE

DESIGN ELEMENTS

Lettering	MOZART (script), FUTURA BOOK (block)
Motif	MOT1528A Table
Ink	REGENT BLUE
Process	THERMOGRAPHY
Paper	PEARL WHITE KID FINISH®

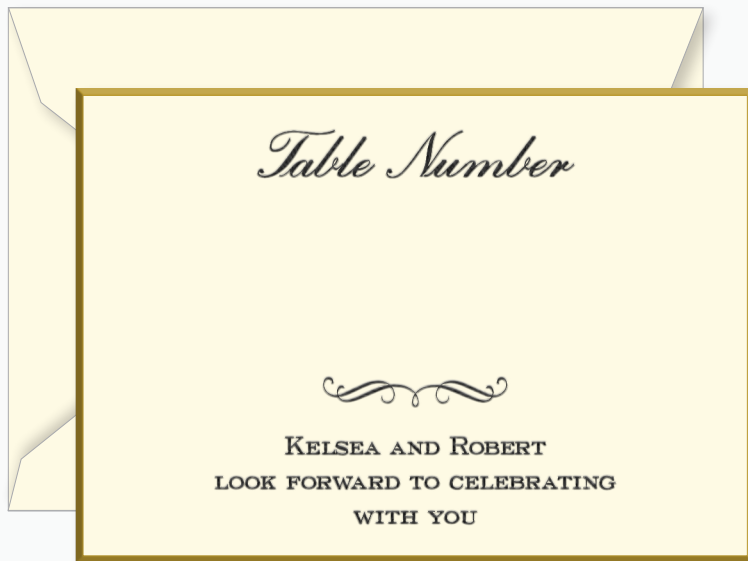

PAPER CODE	DESCRIPTION	WEIGHT	PRICE GROUP
GB31-130	GOLD BEVEL TABLE CARD	96#	FF
E82-130	TABLE CARD ENVELOPE	32#	FF

DESIGN ELEMENTS

Lettering	ROYAL SCRIPT, LIGHT FRENCH ROMAN (block)
Motif	MOT570D Swirl
Ink	CHARCOAL
Process	ENGRAVING
Paper	ECRU KID FINISH®

PLEASE NOTE:
 • The Gold Bevel Table Card is reserved for engraving or blind embossing only.



PAPER CODE	DESCRIPTION	WEIGHT	PRICE GROUP
V19-130	BEACH GLASS TABLE CARD	96#	EE
E91-130	TABLE CARD ENVELOPE	32#	EE

DESIGN ELEMENTS

Lettering	SERLIO (shown all small caps with letter spacing added)
Monogram	MON439A
Ink	GOLD
Process	ENGRAVING
Paper	BEACH GLASS KID FINISH®, PEARL WHITE KID FINISH®

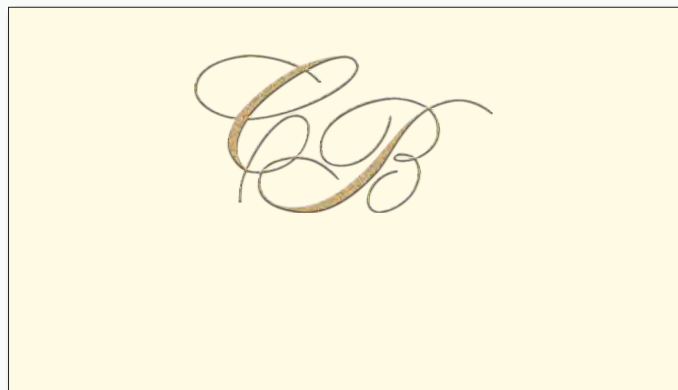

PAPER CODE	DESCRIPTION	WEIGHT	PRICE GROUP
T84-124	ECRU PLACE CARD	64#	EE
E82-124	PLACE CARD ENVELOPE (not shown)	32#	EE

DESIGN ELEMENTS

Monogram	MON542A
Ink	GOLD
Process	ENGRAVING
Paper	ECRU KID FINISH®



PAPER CODE	DESCRIPTION	WEIGHT	PRICE GROUP
T91-124	PEARL WHITE PLACE CARD	64#	EE
E91-124	PLACE CARD ENVELOPE (not shown)	32#	EE

DESIGN ELEMENTS

Lettering	ROYAL SCRIPT
Motif	MOT1116B Calligraphy Flourish
Ink	FRENCH BLUE
Process	THERMOGRAPHY
Paper	PEARL WHITE KID FINISH®



Crane

DESIGN ELEMENTS

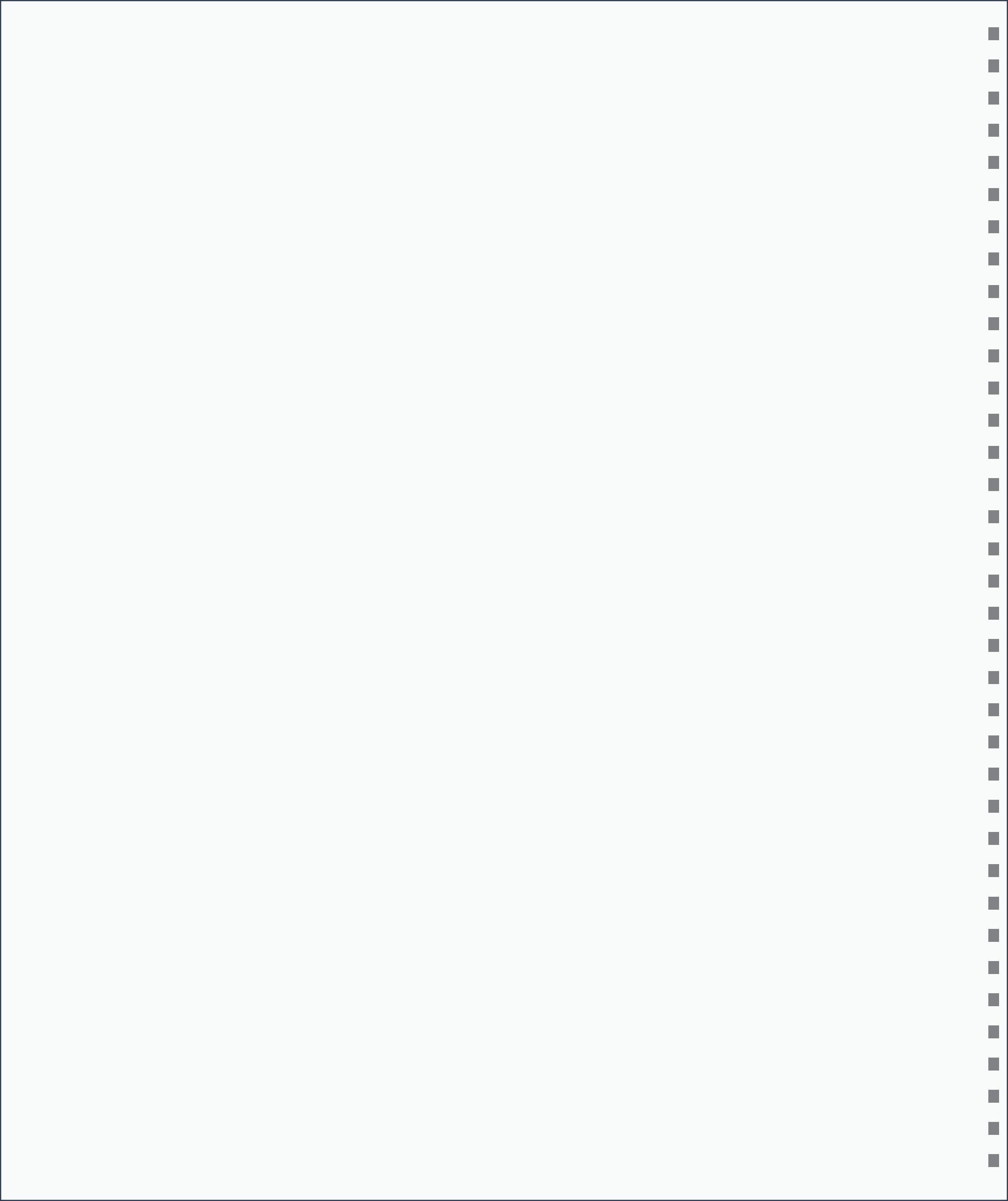

CRANE PAPERS

PLEASE NOTE:

- PREMIUM WEIGHT 192# KID FINISH AND 110# AND 220# LETTRA PAPERS ARE RESERVED FOR ENGRAVING OR LETTERPRESS PRINTING ONLY.
- INSIDE ENVELOPES WILL BE SUPPLIED UNGUMMED.
- DOUBLE ENVELOPES ARE NOT AVAILABLE FOR COLORED PAPERS.

PAPER CODE	FORMAT	COLOR	FINISH	WEIGHT	MEASUREMENTS
ROYALTY (SIZE 50)					
LC0101	Flat Card	Pearl White	Kid	96#	6 3/16" x 8 7/8"
LC0141	Pearl Frame Flat Card	Pearl White	Kid	96#	6 3/16" x 8 7/8"
LC0871	Gold Triple Border Frame Flat Card	Pearl White	Kid	96#	6 3/16" x 8 7/8"
LCR0161	Premium Weight Flat Card	Pearl White	Kid	192#	6 3/16" x 8 13/16"
LCR0161LB	Premium Weight Flat Card Oversized for Luxury Bevel	Pearl White	Kid	192#	6 3/16" x 8 13/16"
LCR0201	Premium Weight Flat Card with Silver Bevel	Pearl White	Kid	192#	6 3/16" x 8 13/16"
LCR0361	Premium Weight Flat Card with Gilt Edge	Pearl White	Kid	192#	6 3/16" x 8 13/16"
LF0111	Folder	Pearl White	Kid	64#	6 3/16" x 8 3/4"
W13	Inside Envelope	Pearl White	Kid	32#	6 3/8 x 9 3/16"
W33	Outside Envelope	Pearl White	Kid	32#	6 9/16 x 9 7/16"
LE0111	Single Envelope	Pearl White	Kid	32#	6 3/8 x 9 3/16"
LC0721	Flat Card	Pearl White	Lettra	110#	6 3/16" x 8 7/8"
LCR0261	Premium Weight Flat Card	Pearl White	Lettra	220#	6 3/16" x 8 13/16"
W54	Inside Envelope	Pearl White	Lettra	32#	6 3/8 x 9 3/16"
W55	Outside Envelope	Pearl White	Lettra	32#	6 9/16 x 9 7/16"
LE0721	Single Envelope	Pearl White	Lettra	32#	6 3/8 x 9 3/16"
LC0106	Flat Card	Ecru	Kid	96#	6 3/16" x 8 7/8"
LC0116	Flat Card with Gold Bevel	Ecru	Kid	96#	6 3/16" x 8 7/8"
LC0456	Classic Embossed Flat Card	Ecru	Kid	96#	6 3/16" x 8 7/8"
LC0536	Beveled Panel Flat Card	Ecru	Kid	96#	6 3/16" x 8 7/8"
LCR0166	Premium Weight Flat Card	Ecru	Kid	192#	6 3/16" x 8 13/16"
LCR0166LB	Premium Weight Flat Card Oversized for Luxury Bevel	Ecru	Kid	192#	6 3/16" x 8 13/16"
LCR0206	Premium Weight Flat Card with Gold Bevel	Ecru	Kid	192#	6 3/16" x 8 13/16"
LCR0366	Premium Weight Flat Card with Gilt Edge	Ecru	Kid	192#	6 3/16" x 8 13/16"
LCR0446	Premium Weight Stately Corners Flat Card	Ecru	Kid	192#	6 3/16" x 8 13/16"
LCR0996	Premium Weight Gold Ink Edged Flat Card	Ecru	Kid	192#	6 3/16" x 8 13/16"
LF0116	Folder	Ecru	Kid	64#	6 3/16" x 8 3/4"
W17	Inside Envelope	Ecru	Kid	32#	6 3/8 x 9 3/16"
W37	Outside Envelope	Ecru	Kid	32#	6 9/16 x 9 7/16"
LE0116	Single Envelope	Ecru	Kid	32#	6 3/8 x 9 3/16"
LC0726	Flat Card	Ecru	Lettra	110#	6 3/16" x 8 7/8"
LCR0266	Premium Weight Flat Card	Ecru	Lettra	220#	6 3/16" x 8 13/16"
W57	Inside Envelope	Ecru	Lettra	32#	6 3/8 x 9 3/16"
W59	Outside Envelope	Ecru	Lettra	32#	6 9/16 x 9 7/16"
LE0726	Single Envelope	Ecru	Lettra	32#	6 3/8 x 9 3/16"
LC0322	Flat Card	Beach Glass	Kid	96#	6 3/16" x 8 7/8"
LCR0322	Premium Weight Flat Card	Beach Glass	Kid	192#	6 3/16" x 8 13/16"
LE0322	Single Envelope	Beach Glass	Kid	32#	6 3/8 x 9 3/16"
EMBASSY (SIZE 9)					
LC9111	Flat Card	Pearl White	Kid	96#	5 1/2" x 7 1/2"
LC9061	Premium Weight Flat Card with Gilt Edge	Pearl White	Kid	192#	5 1/2" x 7 7/16"

W-2023

CRANE PAPERS

PAPER CODE	FORMAT	COLOR	FINISH	WEIGHT	MEASUREMENTS
EMBASSY (SIZE 9) CONTINUED					
LC9531	Beveled Panel Flat Card	Pearl White	Kid	96#	5 1/2" x 7 1/2"
LC9661	Premium Weight Flat Card	Pearl White	Kid	192#	5 1/2" x 7 7/16"
LC9661LB	Premium Weight Flat Card Oversized for Luxury Bevel	Pearl White	Kid	192#	5 1/2" x 7 7/16"
LC9921	Premium Weight Flat Card with Gold Bevel	Pearl White	Kid	192#	5 1/2" x 7 7/16"
LC9981	Beaded Frame Flat Card	Pearl White	Kid	96#	5 1/2" x 7 1/2"
C9111BLK	Black Bordered Flat Card	Pearl White	Kid	96#	5 1/2" x 7 1/2"
C9111PLT	Platinum Bordered Flat Card	Pearl White	Kid	96#	5 1/2" x 7 1/2"
C9111NVY	Navy Bordered Flat Card	Pearl White	Kid	96#	5 1/2" x 7 1/2"
GB9111	Flat Card with Gold Bevel	Pearl White	Kid	96#	5 1/2" x 7 1/2"
GB9121	Flat Card with Gold Bevel Round Corner	Pearl White	Kid	96#	5 1/2" x 7 1/2"
SB9111	Flat Card with Silver Bevel	Pearl White	Kid	96#	5 1/2" x 7 1/2"
SB9121	Flat Card with Silver Bevel Round Corner	Pearl White	Kid	96#	5 1/2" x 7 1/2"
SB9201	Premium Weight Flat Card with Silver Bevel	Pearl White	Kid	192#	5 1/2" x 7 7/16"
LF9111	Folder	Pearl White	Kid	64#	5 1/2" x 7 3/8"
W60	Inside Envelope	Pearl White	Kid	32#	5 3/4" x 7 11/16"
W80	Outside Envelope	Pearl White	Kid	32#	5 7/8" x 7 7/8"
LE9111	Single Envelope	Pearl White	Kid	32#	5 3/4" x 7 11/16"
LC9821	Flat Card	Pearl White	Lettra	110#	5 1/2" x 7 1/2"
LC9781	Elegant Frame Flat Card	Pearl White	Lettra	110#	5 1/2" x 7 1/2"
LC9901	Premium Weight Flat Card	Pearl White	Lettra	220#	5 1/2" x 7 7/16"
W90	Inside Envelope	Pearl White	Lettra	32#	5 3/4" x 7 11/16"
W91	Outside Envelope	Pearl White	Lettra	32#	5 7/8" x 7 7/8"
LE9821	Single Envelope	Pearl White	Lettra	32#	5 3/4" x 7 11/16"
LC9116	Flat Card	Ecu	Kid	96#	5 1/2" x 7 1/2"
LC9066	Premium Weight Flat Card with Gilt Edge	Ecu	Kid	192#	5 1/2" x 7 7/16"
LC9516	Pearl and Beveled Panel Flat Card	Ecu	Kid	96#	5 1/2" x 7 1/2"
LC9556	Embossed Frame Flat Card	Ecu	Kid	96#	5 1/2" x 7 1/2"
LC9666	Premium Weight Flat Card	Ecu	Kid	192#	5 1/2" x 7 7/16"
LC9666LB	Premium Weight Flat Card Oversized for Luxury Bevel	Ecu	Kid	192#	5 1/2" x 7 7/16"
LC9986	Beaded Frame Flat Card	Ecu	Kid	96#	5 1/2" x 7 1/2"
C9116BLK	Black Bordered Flat Card	Ecu	Kid	96#	5 1/2" x 7 1/2"
C9116GLD	Gold Bordered Flat Card	Ecu	Kid	96#	5 1/2" x 7 1/2"
C9116PRL	Pearl Bordered Flat Card	Ecu	Kid	96#	5 1/2" x 7 1/2"
GB9116	Flat Card with Gold Bevel	Ecu	Kid	96#	5 1/2" x 7 1/2"
GB9126	Flat Card with Gold Bevel Round Corner	Ecu	Kid	96#	5 1/2" x 7 1/2"
GB9206	Premium Weight Flat Card with Gold Bevel	Ecu	Kid	192#	5 1/2" x 7 7/16"
LF9116	Folder	Ecu	Kid	64#	5 1/2" x 7 3/8"
W88	French Fold Wedding Sheet	Ecu	Kid	40#	5 1/2" x 7 1/2"
W65	Inside Envelope	Ecu	Kid	32#	5 3/4" x 7 11/16"
W85	Outside Envelope	Ecu	Kid	32#	5 7/8" x 7 7/8"
LE9116	Single Envelope	Ecu	Kid	32#	5 3/4" x 7 11/16"
LC9826	Flat Card	Ecu	Lettra	110#	5 1/2" x 7 1/2"
LC9906	Premium Weight Flat Card	Ecu	Lettra	220#	5 1/2" x 7 7/16"
W95	Inside Envelope	Ecu	Lettra	32#	5 3/4" x 7 11/16"

CRANE PAPERS

PAPER CODE	FORMAT	COLOR	FINISH	WEIGHT	MEASUREMENTS
EMBASSY (SIZE 9) CONTINUED					
W96	Outside Envelope	Ecru	Lettra	32#	5 7/8" x 7 7/8"
LE9326	Single Envelope	Ecru	Lettra	32#	5 3/4" x 7 11/16"
LC9322	Flat Card	Beach Glass	Kid	96#	5 1/2" x 7 1/2"
LE9322	Single Envelope	Beach Glass	Kid	32#	5 3/4" x 7 11/16"
LC9482	Flat Card	Navy	Kid	96#	5 1/2" x 7 1/2"
LE9482	Single Envelope	Navy	Kid	32#	5 3/4" x 7 11/16"
LC9123	Flat Card	Light Pink	Impress	110C	5 1/2" x 7 1/2"
LE9123	Single Envelope	Light Pink	Impress	32W	5 3/4" x 7 11/16"
LC9112	Flat Card	Light Gray	Impress	110C	5 1/2" x 7 1/2"
LE9112	Single Envelope	Light Gray	Impress	32W	5 3/4" x 7 11/16"
MARQUIS (SIZE 80)					
LCM111	Flat Card	Pearl White	Kid	96#	6 3/4" x 6 3/4"
LEM131	Inside Envelope	Pearl White	Kid	32#	7" x 7"
LEM141	Outside Envelope	Pearl White	Kid	32#	7 5/16" x 7 5/16"
LEM131G	Single Envelope	Pearl White	Kid	32#	7" x 7"
LCM116	Flat Card	Ecru	Kid	96#	6 3/4" x 6 3/4"
LCM106	Trailing Leaves Flat Card	Ecru	Kid	96#	6 3/4" x 6 3/4"
LEM136	Inside Envelope	Ecru	Kid	32#	7" x 7"
LEM146	Outside Envelope	Ecru	Kid	32#	7 5/16" x 7 5/16"
LEM136G	Single Envelope	Ecru	Kid	32#	7" x 7"
KENT (SIZE 3)					
LC3111	Flat Card	Pearl White	Kid	96#	4 1/4" x 6 3/8"
LC3011	Embossed Pantheon Flat Card	Pearl White	Kid	96#	4 1/4" x 6 3/8"
LC31121	Bar Panel Flat Card	Pearl White	Kid	96#	4 1/4" x 6 3/8"
GB3111	Flat Card with Gold Bevel	Pearl White	Kid	96#	4 1/4" x 6 3/8"
LC3281	Bevel Panel Flat Card	Pearl White	Kid	96#	4 1/4" x 6 3/8"
C3111BLK	Black Bordered Flat Card	Pearl White	Kid	96#	4 1/4" x 6 3/8"
C3111CHAR	Charcoal Bordered Flat Card	Pearl White	Kid	96#	4 1/4" x 6 3/8"
C3111GLD	Gold Bordered Flat Card	Pearl White	Kid	96#	4 1/4" x 6 3/8"
C3111HGRN	Hunter Green Bordered Flat Card	Pearl White	Kid	96#	4 1/4" x 6 3/8"
C3111INVY	Navy Bordered Flat Card	Pearl White	Kid	96#	4 1/4" x 6 3/8"
C3111NWP	Newport Blue Bordered Flat Card	Pearl White	Kid	96#	4 1/4" x 6 3/8"
C3111PLT	Platinum Bordered Flat Card	Pearl White	Kid	96#	4 1/4" x 6 3/8"
C3111RED	Red Bordered Flat Card	Pearl White	Kid	96#	4 1/4" x 6 3/8"
C3111REG	Regent Blue Bordered Flat Card	Pearl White	Kid	96#	4 1/4" x 6 3/8"
GB3201	Premium Weight Flat Card with Gold Bevel	Pearl White	Kid	192#	4 1/4" x 6 3/8"
LF3111	Heavyweight Note	Pearl White	Kid	64#	4 1/4" x 6 1/4"
LF31121	Bar Panel Heavyweight Note	Pearl White	Kid	64#	4 1/4" x 6 1/4"
LF31271	Embossed Pantheon Heavyweight Note	Pearl White	Kid	64#	4 1/4" x 6 1/4"
LH3111	Half Sheet	Pearl White	Kid	32#	6 3/8" x 8 1/2"
LH3281	Bevel Panel Half Sheet	Pearl White	Kid	32#	6 3/8" x 8 1/2"
H3111NWP	Newport Blue Bordered Half Sheet	Pearl White	Kid	32#	6 3/8" x 8 1/2"
LE3111	Envelope	Pearl White	Kid	32#	4 3/8" x 6 9/16"
LE3721	Newport Blue Bordered Envelope	Pearl White	Kid	32#	4 3/8" x 6 9/16"

W-2023

CRANE PAPERS

PAPER CODE	FORMAT	COLOR	FINISH	WEIGHT	MEASUREMENTS
KENT (SIZE 3) CONTINUED					
LC3821	Flat Card	Pearl White	Lettra	110#	4 1/4" x 6 3/8"
LH3821	Half Sheet	Pearl White	Lettra	32#	6 3/8" x 8 1/2"
LE3821	Envelope	Pearl White	Lettra	32#	4 3/8" x 6 9/16"
LC3208	Flat Card	Fluorescent White	Kid	96#	4 1/4" x 6 3/8"
LH3208	Half Sheet	Fluorescent White	Kid	32#	6 3/8" x 8 1/2"
LE3208	Envelope	Fluorescent White	Kid	32#	4 3/8" x 6 9/16"
LC3116	Flat Card	Ecru	Kid	96#	4 1/4" x 6 3/8"
GB3116	Flat Card with Gold Bevel	Ecru	Kid	96#	4 1/4" x 6 3/8"
GB3126	Flat Card with Gold Bevel and Round Corners	Ecru	Kid	96#	4 1/4" x 6 3/8"
LC3286	Bevel Panel Flat Card	Ecru	Kid	96#	4 1/4" x 6 3/8"
LC30626	Rounded Bar Panel Flat Card	Ecru	Kid	96#	4 1/4" x 6 3/8"
LC31126	Bar Panel Flat Card	Ecru	Kid	96#	4 1/4" x 6 3/8"
LC3186	Embossed Bevel Frame Flat Card	Ecru	Kid	96#	4 1/4" x 6 3/8"
LC3016	Embossed Pantheon Flat Card	Ecru	Kid	96#	4 1/4" x 6 3/8"
C3116BLK	Black Bordered Flat Card	Ecru	Kid	96#	4 1/4" x 6 3/8"
C3116CHAR	Charcoal Bordered Flat Card	Ecru	Kid	96#	4 1/4" x 6 3/8"
C3116GLD	Gold Bordered Flat Card	Ecru	Kid	96#	4 1/4" x 6 3/8"
C3116HGRN	Hunter Green Bordered Flat Card	Ecru	Kid	96#	4 1/4" x 6 3/8"
C3116NVY	Navy Bordered Flat Card	Ecru	Kid	96#	4 1/4" x 6 3/8"
C3116PLT	Platinum Bordered Flat Card	Ecru	Kid	96#	4 1/4" x 6 3/8"
C3116RED	Red Bordered Flat Card	Ecru	Kid	96#	4 1/4" x 6 3/8"
C3116REG	Regent Blue Bordered Flat Card	Ecru	Kid	96#	4 1/4" x 6 3/8"
GB3206	Premium Weight Flat Card with Gold Bevel	Ecru	Kid	192#	4 1/4" x 6 3/8"
LF3116	Heavyweight Note	Ecru	Kid	64#	4 1/4" x 6 1/4"
LF31126	Bar Panel Heavyweight Note	Ecru	Kid	64#	4 1/4" x 6 1/4"
LF31276	Embossed Pantheon Heavyweight Note	Ecru	Kid	64#	4 1/4" x 6 1/4"
LH3116	Half Sheet	Ecru	Kid	32#	6 3/8" x 8 1/2"
LH3286	Bevel Panel Half Sheet	Ecru	Kid	32#	6 3/8" x 8 1/2"
LH30626	Rounded Bar Panel Half Sheet	Ecru	Kid	32#	6 3/8" x 8 1/2"
LH3016	Embossed Pantheon Half Sheet	Ecru	Kid	32#	6 3/8" x 8 1/2"
H3116CHAR	Charcoal Bordered Half Sheet	Ecru	Kid	32#	6 3/8" x 8 1/2"
H3116NVY	Navy Bordered Half Sheet	Ecru	Kid	32#	6 3/8" x 8 1/2"
H3116RED	Red Bordered Half Sheet	Ecru	Kid	32#	6 3/8" x 8 1/2"
H3116REG	Regent Blue Bordered Half Sheet	Ecru	Kid	32#	6 3/8" x 8 1/2"
LE3116	Envelope	Ecru	Kid	32#	4 3/8" x 6 9/16"
LC3826	Flat Card	Ecru	Lettra	110#	4 1/4" x 6 3/8"
LH3826	Half Sheet	Ecru	Lettra	32#	6 3/8" x 8 1/2"
LE3826	Envelope	Ecru	Lettra	32#	4 3/8" x 6 9/16"
LC3322	Flat Card	Beach Glass	Kid	96#	4 1/4" x 6 3/8"
LH3322	Half Sheet	Beach Glass	Kid	32#	6 3/8" x 8 1/2"
LE3322	Envelope	Beach Glass	Kid	32#	4 3/8" x 6 9/16"
LC3482	Flat Card	Navy	Kid	96#	4 1/4" x 6 3/8"
LE3482	Envelope	Navy	Kid	32#	4 3/8" x 6 9/16"
LC3123	Flat Card	Light Pink	Impress	110C	4 1/4" x 6 3/8"

CRANE PAPERS

PAPER CODE	FORMAT	COLOR	FINISH	WEIGHT	MEASUREMENTS
KENT (SIZE 3) CONTINUED					
LE3123	Envelope	Light Pink	Impress	32W	4 3/8" x 6 9/16"
LC3112	Flat Card	Light Gray	Impress	110C	4 1/4" x 6 3/8"
LH3112	Half Sheet	Light Gray	Impress	32W	6 3/8" x 8 1/2"
LE3112	Envelope	Light Gray	Impress	32W	4 3/8" x 6 9/16"
CORINNE (SIZE 1)					
LC1111	Flat Card	Pearl White	Kid	96#	3 13/16" x 5 5/16"
LC1141	Pearl Frame Flat Card	Pearl White	Kid	96#	3 13/16" x 5 5/16"
LC1531	Beveled Panel Flat Card	Pearl White	Kid	96#	3 13/16" x 5 5/16"
LC1871	Gold Triple Border Frame Flat Card	Pearl White	Kid	96#	3 13/16" x 5 5/16"
LC1981	Beaded Frame Flat Card	Pearl White	Kid	96#	3 13/16" x 5 5/16"
C1111BLK	Black Bordered Flat Card	Pearl White	Kid	96#	3 13/16" x 5 5/16"
C1111NVY	Navy Bordered Flat Card	Pearl White	Kid	96#	3 13/16" x 5 5/16"
C1111PLT	Platinum Bordered Flat Card	Pearl White	Kid	96#	3 13/16" x 5 5/16"
GB1111	Flat Card with Gold Bevel	Pearl White	Kid	96#	3 13/16" x 5 5/16"
GB1121	Flat Card with Gold Bevel Round Cornered	Pearl White	Kid	96#	3 13/16" x 5 5/16"
SB1111	Flat Card with Silver Bevel	Pearl White	Kid	96#	3 13/16" x 5 5/16"
SB1201	Flat Card with Silver Bevel Round Cornered	Pearl White	Kid	96#	3 13/16" x 5 5/16"
LC1661	Premium Weight Flat Card	Pearl White	Kid	192#	3 13/16" x 5 1/4"
LC1061	Premium Weight Flat Card with Gilt Edge	Pearl White	Kid	192#	3 13/16" x 5 1/4"
LC1921	Premium Weight Flat Card with Gold Bevel	Pearl White	Kid	192#	3 13/16" x 5 1/4"
LC1941	Premium Weight Flat Card with Silver Bevel	Pearl White	Kid	192#	3 13/16" x 5 1/4"
LN1111	Note	Pearl White	Kid	32#	3 13/16" x 5 5/16"
LF1111	Heavyweight Note	Pearl White	Kid	64#	3 13/16" x 5 3/16"
LF1281	Beveled Panel Heavyweight Note	Pearl White	Kid	64#	3 13/16" x 5 3/16"
LF11121	Bar Panel Heavyweight Note	Pearl White	Kid	64#	3 13/16" x 5 3/16"
LF1011	Embossed Pantheon Heavyweight Note	Pearl White	Kid	64#	3 13/16" x 5 3/16"
LF1831	Embossed Cross Heavyweight Note	Pearl White	Kid	64#	3 13/16" x 5 3/16"
LF1861	Classic Star of David Heavyweight Note	Pearl White	Kid	64#	3 13/16" x 5 3/16"
F1111BLK	Black Bordered Heavyweight Note	Pearl White	Kid	64#	3 13/16" x 5 3/16"
F1111CHAR	Charcoal Bordered Heavyweight Note	Pearl White	Kid	64#	3 13/16" x 5 3/16"
F1111GLD	Gold Bordered Heavyweight Note	Pearl White	Kid	64#	3 13/16" x 5 3/16"
F1111HGRN	Hunter Green Bordered Heavyweight Note	Pearl White	Kid	64#	3 13/16" x 5 3/16"
F1111NVY	Navy Bordered Heavyweight Note	Pearl White	Kid	64#	3 13/16" x 5 3/16"
F1111PLT	Platinum Bordered Heavyweight Note	Pearl White	Kid	64#	3 13/16" x 5 3/16"
F1111RED	Red Bordered Heavyweight Note	Pearl White	Kid	64#	3 13/16" x 5 3/16"
F1111REG	Regent Blue Bordered Heavyweight Note	Pearl White	Kid	64#	3 13/16" x 5 3/16"
LE1111	Envelope	Pearl White	Kid	32#	3 15/16" x 5 9/16"
LC1721	Flat Card	Pearl White	Lettra	110#	3 13/16" x 5 5/16"
LC1901	Premium Weight Flat Card	Pearl White	Lettra	220#	3 13/16" x 5 1/4"
LC1781	Elegant Frame Flat Card	Pearl White	Lettra	110#	3 13/16" x 5 5/16"
LN1121	Note	Pearl White	Lettra	32#	3 13/16" x 5 5/16"
LF1721	Heavyweight Note	Pearl White	Lettra	110#	3 13/16" x 5 3/16"
LE1721	Envelope	Pearl White	Lettra	32#	3 15/16" x 5 9/16"
LC1208	Flat Card	Fluorescent White	Kid	96#	3 13/16" x 5 5/16"

W-2023

CRANE PAPERS

PAPER CODE	FORMAT	COLOR	FINISH	WEIGHT	MEASUREMENTS
CORINNE (SIZE 1) CONTINUED					
LN1208	Note	Fluorescent White	Kid	32#	3 13/16" x 5 5/16"
LE1208	Envelope	Fluorescent White	Kid	32#	3 15/16" x 5 9/16"
LC1116	Flat Card	Ecru	Kid	96#	3 13/16" x 5 5/16"
LC1106	Trailing Leaves Flat Card	Ecru	Kid	96#	3 13/16" x 5 5/16"
LC1536	Beveled Panel Flat Card	Ecru	Kid	96#	3 13/16" x 5 5/16"
LC1556	Embossed Frame Flat Card	Ecru	Kid	96#	3 13/16" x 5 5/16"
LC1986	Beaded Frame Flat Card	Ecru	Kid	96#	3 13/16" x 5 5/16"
C1116BLK	Black Bordered Flat Card	Ecru	Kid	96#	3 13/16" x 5 5/16"
C1116GLD	Gold Bordered Flat Card	Ecru	Kid	96#	3 13/16" x 5 5/16"
C1116PRL	Pearl Bordered Flat Card	Ecru	Kid	96#	3 13/16" x 5 5/16"
GB1116	Flat Card with Gold Bevel	Ecru	Kid	96#	3 13/16" x 5 5/16"
GB1126	Flat Card with Gold Bevel Round Corner	Ecru	Kid	96#	3 13/16" x 5 5/16"
LN1116	Note	Ecru	Kid	32#	3 13/16" x 5 5/16"
LF1116	Heavyweight Note	Ecru	Kid	64#	3 13/16" x 5 3/16"
LF11126	Bar Panel Heavyweight Note	Ecru	Kid	64#	3 13/16" x 5 3/16"
LF1016	Embossed Pantheon Heavyweight Note	Ecru	Kid	64#	3 13/16" x 5 3/16"
LF17436	Interlocking Emboss Frame Heavyweight Note	Ecru	Kid	64#	3 13/16" x 5 3/16"
LF1176	Beveled Frame Heavyweight Note	Ecru	Kid	64#	3 13/16" x 5 3/16"
LF1286	Bevel Panel Heavyweight Note	Ecru	Kid	64#	3 13/16" x 5 3/16"
LF1846	Classic Cross Heavyweight Note	Ecru	Kid	64#	3 13/16" x 5 3/16"
F1116BLK	Black Bordered Heavyweight Note	Ecru	Kid	64#	3 13/16" x 5 3/16"
F1116CHAR	Charcoal Bordered Heavyweight Note	Ecru	Kid	64#	3 13/16" x 5 3/16"
F1116GLD	Gold Bordered Heavyweight Note	Ecru	Kid	64#	3 13/16" x 5 3/16"
F1116HGRN	Hunter Green Bordered Heavyweight Note	Ecru	Kid	64#	3 13/16" x 5 3/16"
F1116NVY	Navy Bordered Heavyweight Note	Ecru	Kid	64#	3 13/16" x 5 3/16"
F1116PLT	Platinum Bordered Heavyweight Note	Ecru	Kid	64#	3 13/16" x 5 3/16"
F1116RED	Red Bordered Heavyweight Note	Ecru	Kid	64#	3 13/16" x 5 3/16"
F1116REG	Regent Blue Bordered Heavyweight Note	Ecru	Kid	64#	3 13/16" x 5 3/16"
LC1666	Premium Weight Flat Card	Ecru	Kid	192#	3 13/16" x 5 1/4"
LC1066	Premium Weight Flat Card with Gilt Edge	Ecru	Kid	192#	3 13/16" x 5 1/4"
GB1206	Premium Weight Flat Card with Gold Bevel	Ecru	Kid	192#	3 13/16" x 5 1/4"
LC1446	Premium Weight Stately Corners Flat Card	Ecru	Kid	192#	3 13/16" x 5 1/4"
LC1996	Premium Weight Gold Ink Edged Flat Card	Ecru	Kid	192#	3 13/16" x 5 1/4"
LE1116	Envelope	Ecru	Kid	32#	3 15/16" x 5 9/16"
LC1026	Flat Card	Ecru	Lettra	110#	3 13/16" x 5 5/16"
LC1906	Premium Weight Flat Card	Ecru	Lettra	220#	3 13/16" x 5 1/4"
LN1126	Note	Ecru	Lettra	32#	3 13/16" x 5 5/16"
LF1326	Heavyweight Note	Ecru	Lettra	110#	3 13/16" x 5 5/16"
LE1326	Envelope	Ecru	Lettra	32#	3 15/16" x 5 9/16"
LC1322	Flat Card	Beach Glass	Kid	96#	3 13/16" x 5 5/16"
LN1322	Note	Beach Glass	Kid	32#	3 13/16" x 5 5/16"
LF1322	Heavyweight Note	Beach Glass	Kid	64#	3 13/16" x 5 3/16"
LE1322	Envelope	Beach Glass	Kid	32#	3 15/16" x 5 9/16"
LC1482	Flat Card	Navy	Kid	96#	3 13/16" x 5 3/16"

CRANE PAPERS

PAPER CODE	FORMAT	COLOR	FINISH	WEIGHT	MEASUREMENTS
CORINNE (SIZE 1) CONTINUED					
LE1482	Envelope	Navy	Kid	32#	3 15/16" x 5 9/16"
LC1123	Flat Card	Light Pink	Impress	110C	3 13/16" x 5 3/16"
LF1123	Heavyweight Note	Light Pink	Impress	90C	3 13/16" x 5 3/16"
LE1123	Envelope	Light Pink	Impress	32W	3 15/16" x 5 9/16"
LC1112	Flat Card	Light Gray	Impress	110C	3 13/16" x 5 5/16"
LF1112	Heavyweight Note	Light Gray	Impress	90C	3 13/16" x 5 3/16"
LE1112	Envelope	Light Gray	Impress	32W	3 15/16" x 5 9/16"
BUSINESS / CALLING CARD (SIZE 124)					
V91-124	Flat Card	Pearl White	Kid	64#	2" x 3 1/2"
T91-124	Tent Card	Pearl White	Kid	64#	2" x 3 1/2"
V30-124	Flat Card	Pearl White	Kid	96#	2" x 3 1/2"
V29-124	Premium Weight Flat Card	Pearl White	Kid	192#	2" x 3 1/2"
E91-124	Envelope	Pearl White	Kid	32#	2 1/4" x 3 5/8"
V95-124	Flat Card	Pearl White	Lettra	110#	2" x 3 1/2"
V97-124	Premium Weight Flat Card	Pearl White	Lettra	220#	2" x 3 1/2"
V99-124	Flat Card	Fluorescent White	Kid	96#	2" x 3 1/2"
V84-124	Flat Card	Ecru	Kid	64#	2" x 3 1/2"
T84-124	Tent Card	Ecru	Kid	64#	2" x 3 1/2"
V31-124	Flat Card	Ecru	Kid	96#	2" x 3 1/2"
V98-124	Premium Weight Flat Card	Ecru	Kid	192#	2" x 3 1/2"
E82-124	Envelope	Ecru	Kid	32#	2 1/4" x 3 5/8"
V96-124	Flat Card	Ecru	Lettra	110#	2" x 3 1/2"
V26-124	Premium Weight Flat Card	Ecru	Lettra	220#	2" x 3 1/2"
V19-124	Flat Card	Beach Glass	Kid	96#	2" x 3 1/2"
V12-124	Flat Card	Light Gray	Impress	110C	2" x 3 1/2"
BUSINESS / CALLING CARD (SIZE 130)					
V91-130	Flat Card	Pearl White	Kid	64#	3 15/32" x 3 7/16"
T91-130	Tent Card	Pearl White	Kid	64#	2 15/32" x 3 7/16"
V30-130	Flat Card	Pearl White	Kid	96#	2 15/32" x 3 7/16"
V29-130	Premium Weight Flat Card	Pearl White	Kid	192#	2 15/32" x 3 7/16"
E91-130	Envelope	Pearl White	Kid	32#	2 5/8" x 3 5/8"
V95-130	Flat Card	Pearl White	Lettra	110#	2 15/32" x 3 7/16"
V97-130	Premium Weight Flat Card	Pearl White	Lettra	220#	2 15/32" x 3 7/16"
V99-130	Flat Card	Fluorescent White	Kid	96#	2 15/32" x 3 7/16"
V84-130	Flat Card	Ecru	Kid	64#	2 15/32" x 3 7/16"
T84-130	Tent Card	Ecru	Kid	64#	2 15/32" x 3 7/16"
V31-130	Flat Card	Ecru	Kid	96#	2 15/32" x 3 7/16"
GB31-130	Flat Card with Gold Bevel	Ecru	Kid	96#	2 15/32" x 3 7/16"
V98-130	Premium Weight Flat Card	Ecru	Kid	192#	2 15/32" x 3 7/16"
E82-130	Envelope	Ecru	Kid	32#	2 5/8" x 3 5/8"
V96-130	Flat Card	Ecru	Lettra	110#	2 15/32" x 3 7/16"
V26-130	Premium Weight Flat Card	Ecru	Lettra	220#	2 15/32" x 3 7/16"
V19-130	Flat Card	Beach Glass	Kid	96#	2 15/32" x 3 7/16"
V12-130	Flat Card	Light Gray	Impress	110C	2 15/32" x 3 7/16"

W-2023

CRANE PAPERS

PAPER CODE	FORMAT	COLOR	FINISH	WEIGHT	MEASUREMENTS
MONARCH (SIZE 7)					
LC7111	Flat Card	Pearl White	Kid	96#	3 13/16" x 7 5/16"
LS7111	Monarch Sheet	Pearl White	Kid	32#	7 1/4" x 10 1/2"
LE7111	Envelope	Pearl White	Kid	32#	3 15/16" x 7 1/2"
LC7116	Flat Card	Ecu	Kid	96#	3 13/16" x 7 5/16"
LC70626	Bar Panel Flat Card	Ecu	Kid	96#	3 13/16" x 7 5/16"
LS7116	Monarch Sheet	Ecu	Kid	32#	7 1/4" x 10 1/2"
LE7116	Envelope	Ecu	Kid	32#	3 15/16" x 7 1/2"
EXECUTIVE (SIZE 8)					
AS8111	Executive Sheet	Pearl White	Kid	32#	8 1/2" x 11"
AE8111	Envelope	Pearl White	Kid	32#	4 1/8" x 9 1/2"
AS8116	Executive Sheet	Ecu	Kid	32#	8 1/2" x 11"
AE8116	Envelope	Ecu	Kid	32#	4 1/8" x 9 1/2"
LS8112	Executive Sheet	Light Gray	Impress	32W	8 1/2" x 11"
LE8112	Envelope	Light Gray	Impress	32W	4 1/8" x 9 1/2"
JOTTERS					
JC-WHITE	Jotter Card	White	Vellum	80# Cover	3" x 5"
JC-ECRU	Jotter Card	Ecu	Vellum	80# Cover	3" x 5"

EDGE TREATMENTS

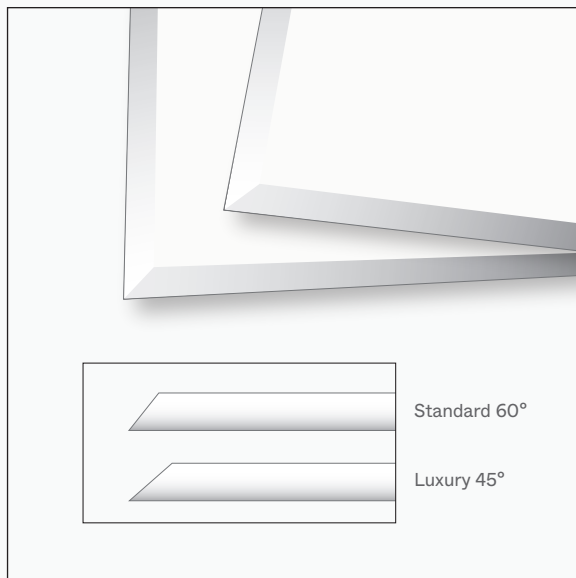

BEVEL EDGE
AVAILABLE IN STANDARD AND LUXURY BEVEL

THE SLANTED CUT EDGE OF A BEVEL GIVES A POLISHED LOOK TO STATIONERY AND INVITATIONS. BEVELS CAN BE APPLIED AT THE STANDARD 60 DEGREE OR THE STRIKING 45 DEGREE LUXURY BEVEL ON SELECT STOCKS. COLOR MAY BE ADDED TO A BEVEL EDGE WITH A CURATED SELECTION OF INK COLORS OR FOILS.

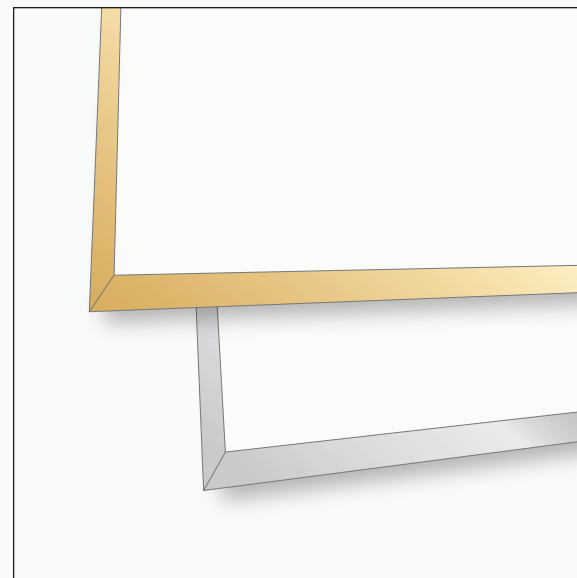

GILDED EDGE
AVAILABLE IN GOLD OR SILVER FOIL

GLEAMING METALLIC EDGES ADD A LUXURIOUS TOUCH THAT IS SURE TO BE REMEMBERED. GOLD OR SILVER FOIL MAY BE APPLIED TO A STRAIGHT OR BEVEL EDGE.

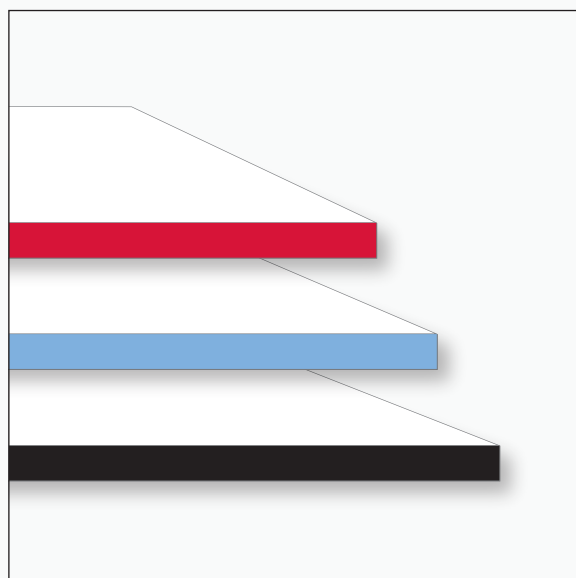

PAINTED EDGE
AVAILABLE IN SELECT CRANE ENGRAVING INK COLORS

STRAIGHT OR BEVELED EDGES GET A LITTLE EXTRA IMPACT WITH A DELIGHTFUL POP OF COLOR. CHOOSE FROM OUR CURATED ENGRAVING INK COLOR SELECTION TO APPLY INK TO THE CUT EDGE OF A CARD.

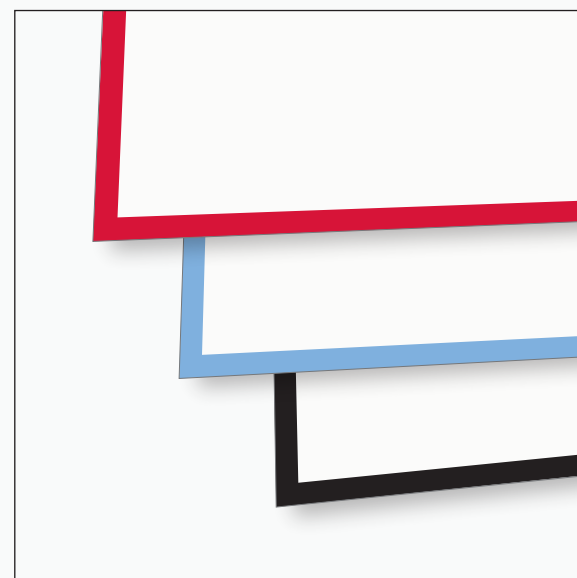

PAINTED BORDER
AVAILABLE IN A CURATED SELECTION OF COLORS

OUR PRE-BORDERED PAPERS ARE CRAFTED USING A FOUR-COLOR PRINTER TO ADD RICH COLOR TO THE OUTSIDE EDGES OF NOTES AND CARDS.

INKS



RED



BURGUNDY



PEONY



CLEMENTINE



MOSS GREEN



CLOVER



HUNTER GREEN



PEACOCK



FRENCH BLUE



NEWPORT BLUE



MARINE BLUE



REGENT BLUE



NAVY



AMETHYST



RASPBERRY



KONA



MUSHROOM



TAUPE



GRAPHITE



CHARCOAL



PEWTER



BLACK

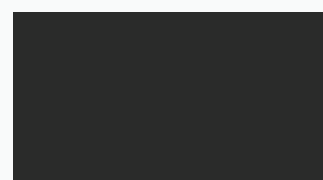

MIDNIGHT
(MATTE THERMOGRAPHY ONLY)

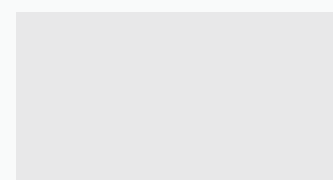

WHITE

METALLICS



POLISHED COPPER



GOLD



PLATINUM



SILVER

ENVELOPE LININGS



SCARLET
LIN388A



MATTE BURGUNDY
LIN1012A



PEONY
LIN442A



HIBISCUS
LIN466A



MOSS GREEN
LIN1073A



WOODLAND
LIN387A



HUNTER GREEN
LIN013A



PEACOCK
LIN266A

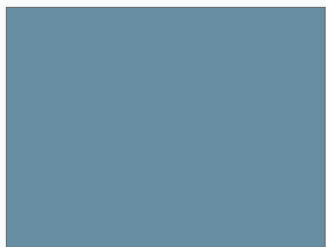

FRENCH BLUE
LIN051A

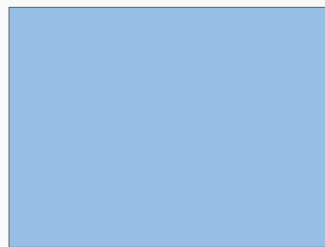

NEWPORT BLUE
LIN233A

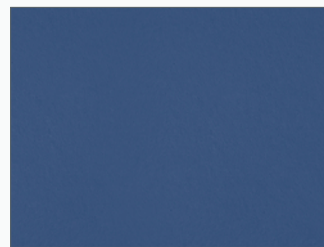

REGENT BLUE
LIN009A

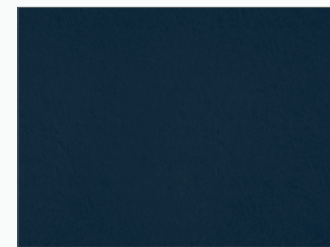

NAVY
LIN131A



LILAC
LIN909A

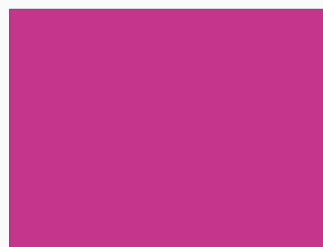

RASPBERRY
LIN058A



KONA
LIN098A



CHARCOAL
LIN017A

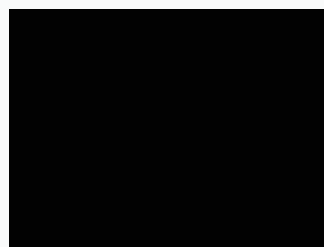

BLACK
LIN135A

ENVELOPE LININGS



GOLD LUSTRE
LIN178B



SATIN GOLD
LIN032A

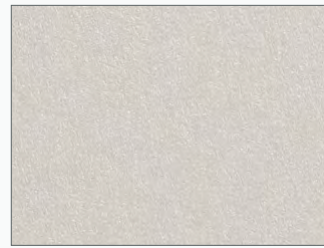

SILVER LUSTRE
LIN177B



SILVER
LIN029A



ANTIQUE GOLD
LIN383A

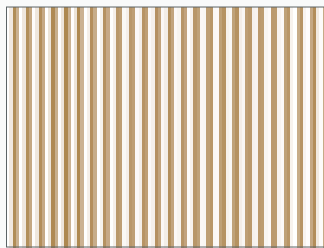

GOLD MICRO STRIPE
LIN284B

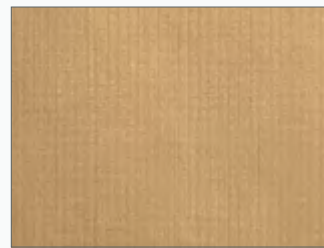

LINEN GOLD
LIN099D



GOLD STRIPES
LIN377B



ROSE GOLD
LIN792A



METALLIC GOLD
LIN443E



VINTAGE GOLD FLORAL
LIN445E

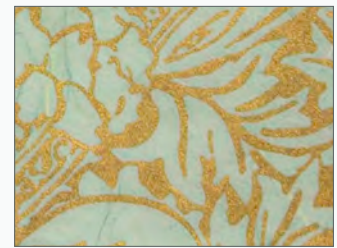

GOLD LEAVES ON GREEN
LIN200C



DAMASK CREAM
LIN469C



GOLD FOIL DAMASK
ON BLACK
LIN468C



GOLDEN SWIRL
LIN382D



GRAY FLORAL
LIN1078B



BLACK GEOMETRIC
LIN861B



BLACK & GOLD DECO
LIN452A

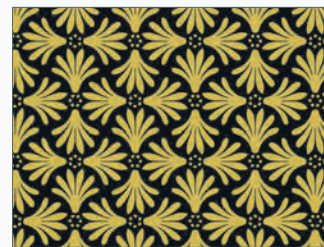

ELEGANT PALM
LIN394B

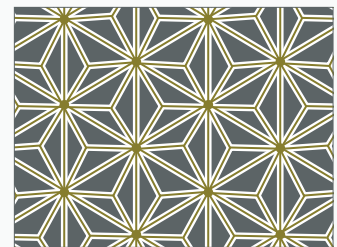

VINTAGE STARLIGHT
LIN397B

ENVELOPE LININGS

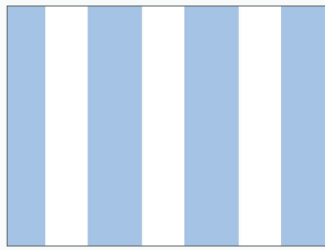

NEWPORT BLUE STRIPE
LIN432B

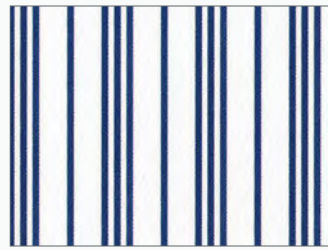

EXECUTIVE PINSTRIPE
LIN074B

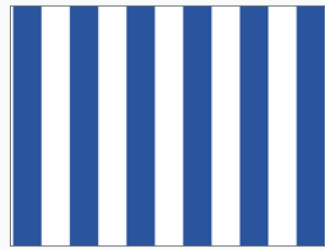

NAUTICAL STRIPE
LIN399B

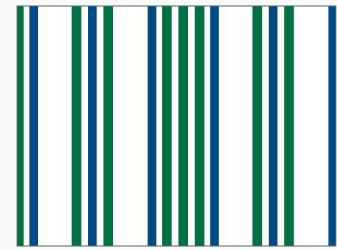

OXFORD STRIPE
LIN418B



BLUE HERRINGBONE
LIN372B

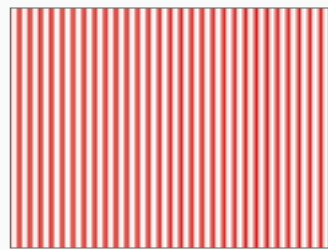

RED MICRO STRIPE
LIN467B

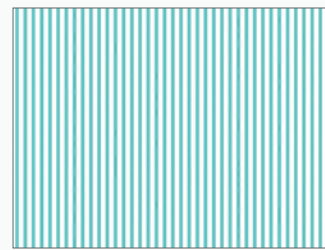

AQUA MICRO STRIPE
LIN286B

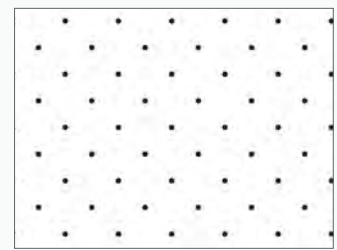

BLACK DOTS
LIN255B



PEWTER & GREEN STRIPE
LIN409B

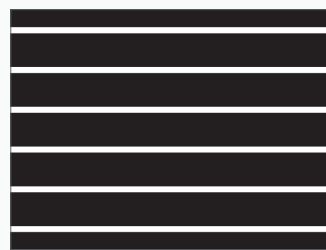

BLACK & WHITE STRIPE
LIN400B



PINK & GREEN STRIPE
LIN091B



VIBRANT LATTICE
LIN070B

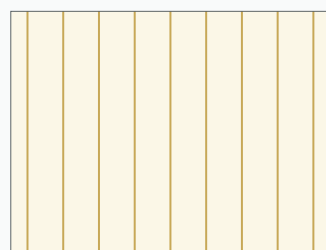

GOLD & ECRU PINSTRIPE
LIN798C



NEON BLUE HERRINGBONE
LIN864B



ORANGE & BLUE STRIPE
LIN089B



RED DIAGONAL
LIN841B

ENVELOPE LININGS



RED FLORENTINE
LIN309C



BLUE FLORENTINE
LIN381D



REGENCY
LIN292C



FLORENTINE GARDEN
LIN444J



DELFT
LIN845B



VINTAGE DAMASK
LIN039B



NAVY FLEUR DE LIS
LIN125B

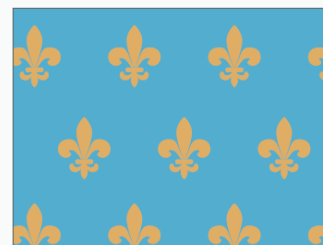

FLEUR DE LIS
LIN863B

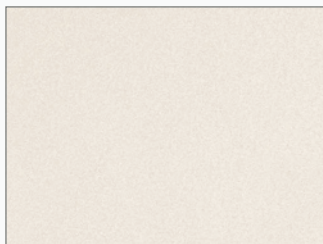

PEARL SHIMMER
LIN277B

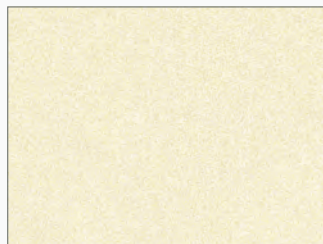

CHAMPAGNE SHIMMER
LIN278B

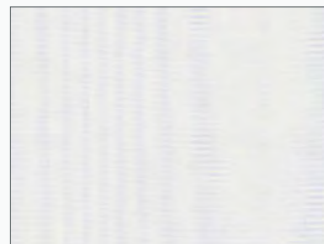

WHITE MOIRE
LIN123D



ECRU MOIRE
LIN122D

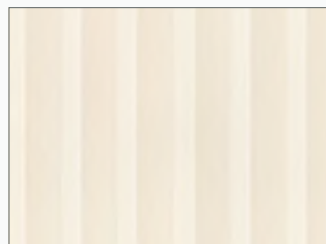

PEARL STRIPE
LIN391B



GREY & GOLD MARBLE
LIN490E

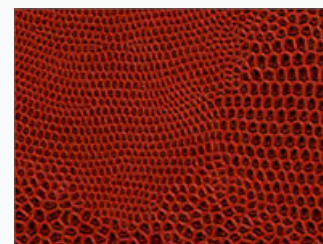

LIZARD
LIN049D



BLUE BONNET FLORAL
LIN1074B



LAUREL SPRIG
LIN1075B



FLORAL BOUQUET
LIN1076B



BLOSSOM
LIN1077B

LETTERING STYLES | Serif

AMERICANA BT
LET501

Mr. and Mrs. William Alexander Beckford
ABCDEFGHIJKLMNOPQRSTUVWXYZ
abcdefghijklmnopqrstuvwxyz & 1234567890

AMERICANA BT EXTRA BOLD
LET502

Mr. and Mrs. William Alexander Beckford
ABCDEFGHIJKLMNOPQRSTUVWXYZ
abcdefghijklmnopqrstuvwxyz & 1234567890

BAUER BODINI
T374

Mr. and Mrs. William Alexander Beckford
ABCDEFGHIJKLMNOPQRSTUVWXYZ
abcdefghijklmnopqrstuvwxyz & 1234567890

BAUER BODONI ITALIC
LET551

Mr. and Mrs. William Alexander Beckford
ABCDEFGHIJKLMNOPQRSTUVWXYZ
abcdefghijklmnopqrstuvwxyz & 1234567890

BEMBO ROMAN
LET543

Mr. and Mrs. William Alexander Beckford
ABCDEFGHIJKLMNOPQRSTUVWXYZ
abcdefghijklmnopqrstuvwxyz & 1234567890

CARLTON STD
LET503

Mr. and Mrs. William Alexander Beckford
ABCDEFGHIJKLMNOPQRSTUVWXYZ
abcdefghijklmnopqrstuvwxyz & 1234567890

CASLON OPEN FACE
T960

MR. AND MRS. WILLIAM ALEXANDER BECKFORD
ABCDEFGHIJKLMNOPQRSTUVWXYZ & 1234567890

CENTAUR MT
T873

Mr. and Mrs. William Alexander Beckford
ABCDEFGHIJKLMNOPQRSTUVWXYZ
abcdefghijklmnopqrstuvwxyz & 1234567890

LETTERING STYLES | Serif

CHEVALIER STD STRIPE
LET507

MR. AND MRS. WILLIAM ALEXANDER BECKFORD
ABCDEFGHIJKLMNOPQRSTUVWXYZ
ABCDEFGHIJKLMNOPQRSTUVWXYZ & 1234567890

COPPERPLATE GOTHIC 32
T880

MR. AND MRS. WILLIAM ALEXANDER BECKFORD
ABCDEFGHIJKLMNOPQRSTUVWXYZ
ABCDEFGHIJKLMNOPQRSTUVWXYZ & 1234567890

COPPERPLATE LIGHT CAP
LET510C

MR. AND MRS. WILLIAM ALEXANDER BECKFORD
ABCDEFGHIJKLMNOPQRSTUVWXYZ & 1234567890

CORONET
LET506S

MR. AND MRS. WILLIAM ALEXANDER BECKFORD
ABCDEFGHIJKLMNOPQRSTUVWXYZ & 1234567890

DIDOT STD ROMAN
LET511

Mr. and Mrs. William Alexander Beckford
ABCDEFGHIJKLMNOPQRSTUVWXYZ
abcdefghijklmnopqrstuvwxyz & 1234567890

DOVER HMK
T493

Mr. and Mrs. William Alexander Beckford
ABCDEFGHIJKLMNOPQRSTUVWXYZ
abcdefghijklmnopqrstuvwxyz & 1234567890

ENG OP AMADEUS
T168

Mr. and Mrs. William Alexander Beckford
ABCDEFGHIJKLMNOPQRSTUVWXYZ
abcdefghijklmnopqrstuvwxyz & 1234567890

ENGRAVERS BOLD ROMAN
LET512

MR. AND MRS. WILLIAM ALEXANDER BECKFORD
ABCDEFGHIJKLMNOPQRSTUVWXYZ
ABCDEFGHIJKLMNOPQRSTUVWXYZ & 1234567890

LETTERING STYLES | Serif

FRANCO ROMAN
T138

MR. AND MRS. WILLIAM ALEXANDER BECKFORD
ABCDEFGHIJKLMNOPQRSTUVWXYZ
ABCDEFGHIJKLMNOPQRSTUVWXYZ & 1234567890

LIGHT FRENCH ROMAN
LET513

MR. AND MRS. WILLIAM ALEXANDER BECKFORD
ABCDEFGHIJKLMNOPQRSTUVWXYZ
ABCDEFGHIJKLMNOPQRSTUVWXYZ & 1234567890

LUBALIN GRAPH EXTRA LIGHT
LET514

Mr. and Mrs. William Alexander Beckford
ABCDEFGHIJKLMNOPQRSTUVWXYZ
abcdefghijklmnopqrstuvwxyz & 1234567890

NEW BASKERVILLE
LET516

Mr. and Mrs. William Alexander Beckford
ABCDEFGHIJKLMNOPQRSTUVWXYZ
abcdefghijklmnopqrstuvwxyz & 1234567890

NEW BASKERVILLE ITALIC
ITC PRO
LET517

Mr. and Mrs. William Alexander Beckford
ABCDEFGHIJKLMNOPQRSTUVWXYZ
abcdefghijklmnopqrstuvwxyz & 1234567890

OLD STYLE 7 STD ROMAN
T315

MR. AND MRS. WILLIAM ALEXANDER BECKFORD
ABCDEFGHIJKLMNOPQRSTUVWXYZ
ABCDEFGHIJKLMNOPQRSTUVWXYZ & 1234567890

OUTLINE ROMAN
LET518

MR. AND MRS. WILLIAM ALEXANDER BECKFORD
ABCDEFGHIJKLMNOPQRSTUVWXYZ
ABCDEFGHIJKLMNOPQRSTUVWXYZ & 1234567890

LETTERING STYLES | Serif

ROMAN SHADED D
LET519

Mr. and Mrs. William Alexander Beckford
ABCDEFGHIJKLMNOPQRSTUVWXYZ
abcdefghijklmnopqrstuvwxyz & 1234567890

SERLIO
LET520

MR. AND MRS. WILLIAM ALEXANDER BECKFORD
ABCDEFGHIJKLMNOPQRSTUVWXYZ
ABCDEFGHIJKLMNOPQRSTUVWXYZ & 1234567890

SHADED ROMAN
LET522

MR. AND MRS. WILLIAM ALEXANDER BECKFORD
ABCDEFGHIJKLMNOPQRSTUVWXYZ
ABCDEFGHIJKLMNOPQRSTUVWXYZ & 1234567890

SOLID ANTIQUE ROMAN PRO
LET523

Mr. and Mrs. William Alexander Beckford
ABCDEFGHIJKLMNOPQRSTUVWXYZ
abcdefghijklmnopqrstuvwxyz & 1234567890

STATESMAN
LET524

Mr. and Mrs. William Alexander Beckford
ABCDEFGHIJKLMNOPQRSTUVWXYZ
abcdefghijklmnopqrstuvwxyz & 1234567890

TRAJAN
T913

MR. AND MRS. WILLIAM ALEXANDER BECKFORD
ABCDEFGHIJKLMNOPQRSTUVWXYZ & 1234567890

LETTERING STYLES | Sans Serif

AVANT GARDE PRO BOOK
LET601

Mr. and Mrs. William Alexander Beckford
ABCDEFGHIJKLMNOPQRSTUVWXYZ
abcdefghijklmnopqrstuvwxyz & 1234567890

BANK GOTHIC LIGHT
LET604

MR. AND MRS. WILLIAM ALEXANDER BECKFORD
ABCDEFGHIJKLMNOPQRSTUVWXYZ
ABCDEFGHIJKLMNOPQRSTUVWXYZ & 1234567890

BENTON REGULAR
LET625

MR. AND MRS. WILLIAM ALEXANDER BECKFORD
ABCDEFGHIJKLMNOPQRSTUVWXYZ & 1234567890

BENTON ITALIC ALL CAPS
LET629C

MR. AND MRS. WILLIAM ALEXANDER BECKFORD
ABCDEFGHIJKLMNOPQRSTUVWXYZ & 1234567890

BERNARD FASHION BT
LET605

Mr. and Mrs. William Alexander Beckford
ABCDEFGHIJKLMNOPQRSTUVWXYZ
abcdefghijklmnopqrstuvwxyz & 1234567890

EXCELSIOR GOTHIC
LET606

MR. AND MRS. WILLIAM ALEXANDER BECKFORD
ABCDEFGHIJKLMNOPQRSTUVWXYZ
ABCDEFGHIJKLMNOPQRSTUVWXYZ & 1234567890

FRUTIGER PRO 45 LIGHT
T476

MR. AND MRS. WILLIAM ALEXANDER BECKFORD
ABCDEFGHIJKLMNOPQRSTUVWXYZ & 1234567890

LETTERING STYLES | Sans Serif

FUTURA BOLD
LET607

Mr. and Mrs. William Alexander Beckford
ABCDEFGHIJKLMNOPQRSTUVWXYZ
abcdefghijklmnopqrstuvwxyz & 1234567890

FUTURA BOOK
LET609S

MR. AND MRS. WILLIAM ALEXANDER BECKFORD
ABCDEFGHIJKLMNOPQRSTUVWXYZ & 1234567890

FUTURA LIGHT
LET619

Mr. and Mrs. William Alexander Beckford
ABCDEFGHIJKLMNOPQRSTUVWXYZ
abcdefghijklmnopqrstuvwxyz & 1234567890

GILL SANS LT
T560

MR. AND MRS. WILLIAM ALEXANDER BECKFORD
ABCDEFGHIJKLMNOPQRSTUVWXYZ & 1234567890

KINGS HAT SANS TEXT
T507

MR. AND MRS. WILLIAM ALEXANDER BECKFORD
ABCDEFGHIJKLMNOPQRSTUVWXYZ & 1234567890

KINGS HAT SANS TEXT BL
T509

MR. AND MRS. WILLIAM ALEXANDER BECKFORD
ABCDEFGHIJKLMNOPQRSTUVWXYZ & 1234567890

LETTERING STYLES | Script

ANGELINA ONE
T390

Mr. and Mrs. William Alexander Beckford
A B C D E F G H I J K L M N O P Q R S T U V W X Y Z
abcdefghijklmnopqrstuvwxyz & 1234567890

BANK GORDON SCRIPT
LET261

Mr. and Mrs. William Alexander Beckford
A B C D E F G H I J K L M N O P Q R S T U V W X Y Z
abcdefghijklmnopqrstuvwxyz & 1234567890

BICKHAM SCRIPT
LET704

Mr. and Mrs. William Alexander Beckford
A B C D E F G H I J K L M N O P Q R S T U V W X Y Z
abcdefghijklmnopqrstuvwxyz & 1234567890

BICKHAM SWASH
LET704W

Mr. and Mrs. William Alexander Beckford
abcdefghijklmnopqrstuvwxyz & 1234567890

BURGUES SCRIPT
LET705

Mr. and Mrs. William Alexander Beckford
A B C D E F G H I J K L M N O P Q R S T U V W X Y Z
abcdefghijklmnopqrstuvwxyz & 1234567890

CITADEL SCRIPT
LET706

Mr. and Mrs. William Alexander Beckford
A B C D E F G H I J K L M N O P Q R S T U V W X Y Z
abcdefghijklmnopqrstuvwxyz & 1234567890

LETTERING STYLES | Script

COLONIAL SCRIPT
LET707

Mr. and Mrs. William Alexander Beckford

A B C D E F G H I J K L M N O P Q R S T U V W X Y Z
abcdefghijklmnopqrstuvwxyz & 1234567890

FEEL SCRIPT
LET709

Mr. and Mrs. William Alexander Beckford

A B C D E F G H I J K L M N O P Q R S T U V W X Y Z
abcdefghijklmnopqrstuvwxyz & 1234567890

HARRINGTON SCRIPT
LET710

Mr. and Mrs. William Alexander Beckford

A B C D E F G H I J K L M N O P Q R S T U V W X Y Z
abcdefghijklmnopqrstuvwxyz & 1234567890

KENSINGTON SCRIPT
LET725

Mr. and Mrs. William Alexander Beckford

A B C D E F G H I J K L M N O P Q R S T U V W X Y Z
abcdefghijklmnopqrstuvwxyz & 1234567890

LA FIGURA
LET165

Mr. and Mrs. William Alexander Beckford

A B C D E F G H I J K L M N O P Q R S T U V W X Y Z
abcdefghijklmnopqrstuvwxyz & 1234567890

LONDON SCRIPT
LET712

Mr. and Mrs. William Alexander Beckford

A B C D E F G H I J K L M N O P Q R S T U V W X Y Z
abcdefghijklmnopqrstuvwxyz & 1234567890

LETTERING STYLES | Script

MOZART
LET728

Mr. and Mrs. William Alexander Beckford
A B C D E F G H I J K L M N O P Q R S T U V W X Y Z
abcdefghijklmnopqrstuvwxyz & 1234567890

PALMER SCRIPT
LET713

Mr. and Mrs. William Alexander Beckford
A B C D E F G H I J K L M N O P Q R S T U V W X Y Z
abcdefghijklmnopqrstuvwxyz & 1234567890

PARFUMERIE SCRIPT
T540

Mr. and Mrs. William Alexander Beckford
A B C D E F G H I J K L M N O P Q R S T U V W X Y Z
abcdefghijklmnopqrstuvwxyz & 1234567890

ROOK SCRIPT
LET714

Mr. and Mrs. William Alexander Beckford
A B C D E F G H I J K L M N O P Q R S T U V W X Y Z
abcdefghijklmnopqrstuvwxyz & 1234567890

ROYAL SCRIPT
LET716

Mr. and Mrs. William Alexander Beckford
A B C D E F G H I J K L M N O P Q R S T U V W X Y Z
abcdefghijklmnopqrstuvwxyz & 1234567890

SHELLEY ALLEGRO
T169

Mr. and Mrs. William Alexander Beckford
A B C D E F G H I J K L M N O P Q R S T U V W X Y Z
abcdefghijklmnopqrstuvwxyz & 1234567890

LETTERING STYLES | Semi-Script

AVALON
LET701

Mr. and Mrs. William Alexander Beckford
A B C D E F G H I J K L M N O P Q R S T U V W X Y Z
abcdefghijklmnopqrstuvwxyz & 1234567890

BAMBOL
LET723

Mr. and Mrs. William Alexander Beckford
A B C D E F G H I J K L M N O P Q R S T U V W X Y Z
abcdefghijklmnopqrstuvwxyz & 1234567890

LIBERTY SCRIPT
LET154

Mr. and Mrs. William Alexander Beckford
A B C D E F G H I J K L M N O P Q R S T U V W X Y Z
abcdefghijklmnopqrstuvwxyz & 1234567890

SNELL ROUNDHAND
LET715

Mr. and Mrs. William Alexander Beckford
A B C D E F G H I J K L M N O P Q R S T U V W X Y Z
abcdefghijklmnopqrstuvwxyz & 1234567890

STUYVESANT SCRIPT SOLID
LET720

Mr. and Mrs. William Alexander Beckford
A B C D E F G H I J K L M N O P Q R S T U V W X Y Z
abcdefghijklmnopqrstuvwxyz & 1234567890

STUYVESANT SCRIPT
LET721

Mr. and Mrs. William Alexander Beckford
A B C D E F G H I J K L M N O P Q R S T U V W X Y Z
abcdefghijklmnopqrstuvwxyz & 1234567890

ZAPFINO ON
T853

Mr. and Mrs. William Alexander Beckford
A B C D E F G H I J K L M N O P Q R S T U V W X Y Z
abcdefghijklmnopqrstuvwxyz & 1234567890

MONOGRAMS

AVAILABLE ON PDS AND THROUGH CONCIERGE



M257



M451



MON200A



MON200B

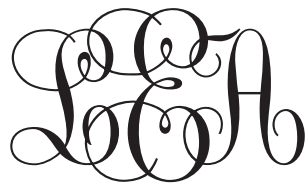

MON200C

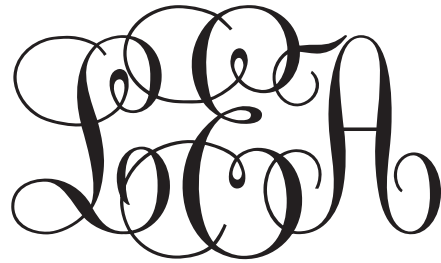

MON200D



MON202A



MON202B



MON202C



MON205A



MON205B



MON206A



MON206B



MON206C



MON206D



MON209A



MON209B



MON216A



MON216B



MON216C

MONOGRAMS

AVAILABLE ON PDS AND THROUGH CONCIERGE



MON216D



MON216E



MON217A



MON217B



MON219A



MON222C



MON224A



MON224B



MON224C

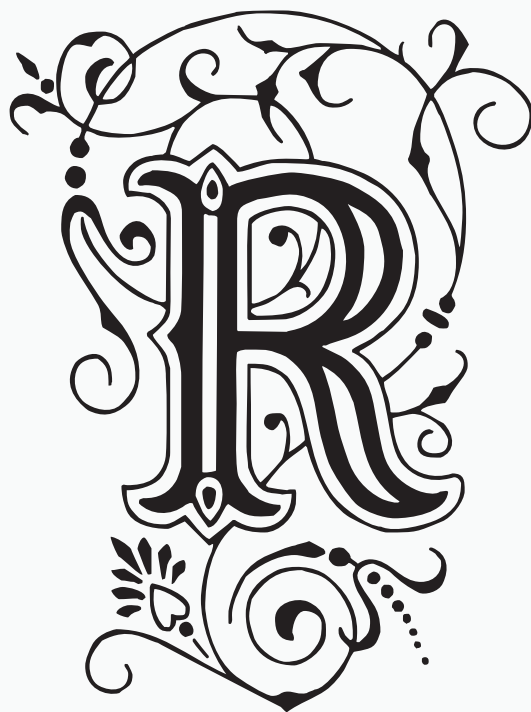

MON224D



MON231A



MON231B

MONOGRAMS

AVAILABLE ON PDS AND THROUGH CONCIERGE



MON233A
MON233C



MON233B



MON233D

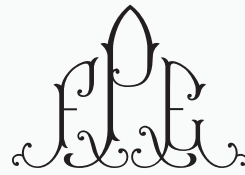

MON259A

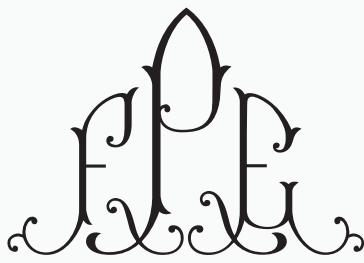

MON259B

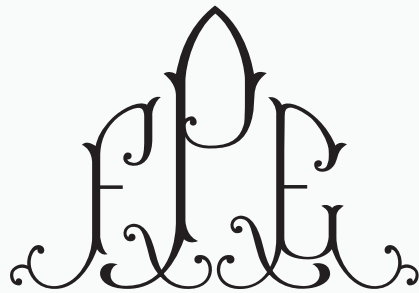

MON259C



MON266A



MON275A



MON281A



MON290A



MON293A



MON293B



MON298A



MON298B



MON299A



MON299B

MONOGRAMS

AVAILABLE ON PDS AND THROUGH CONCIERGE



MON303A



MON303B



MON307A



MON307B



MON330A



MON330B



MON330C



MON333A
MON333B



MON333C



MON334A

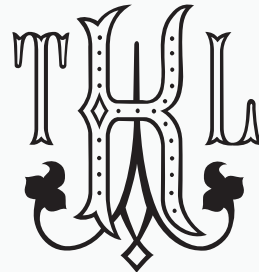

MON334B



MON334C



MON343A



MON343B



MON348A



MON353A



MON362A



MON362B



MON398A

MONOGRAMS

AVAILABLE ON PDS AND THROUGH CONCIERGE



MON398B



MON402A



MON414A



MON439A



MON439B



MON439C



MON439D



MON450A



MON455A



MON455B



MON462A



MON462B



MON462C



MON465A

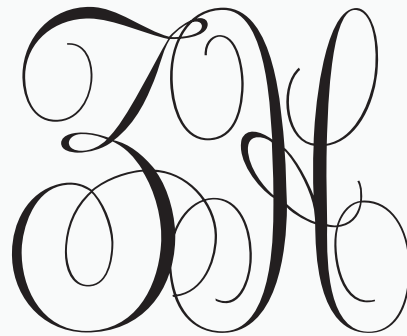

MON472A



MON498A

MONOGRAMS

AVAILABLE ON PDS AND THROUGH CONCIERGE



SML

MON505A



ER

MON507A



F
W

MON512A



F
W

MON512B



E

MON529A



E

MON529B



BA

MON532A



CS

MON542A



W

MON552A



W

MON552B



W

MON552C



W
N

MON555A



BPR

MON556A



IH

MON557A



IH

MON557B



IH

MON557C



V

MON559A

MONOGRAMS
AVAILABLE THROUGH CONCIERGE ONLY



J075



J123A



J123B



J192



J326A



J326B



J326C



J339



J340A



J340B



J341A



J341B



B342A



J342B



J344A



J344B



J345A



J345B



J354A



J354B

MONOGRAMS

AVAILABLE THROUGH CONCIERGE ONLY



J373A



J373B



J390A



J390B



J390C



J526A



J545A



M412A



M412B



M421A



M421B



M531A



M531B



M531C



M531D

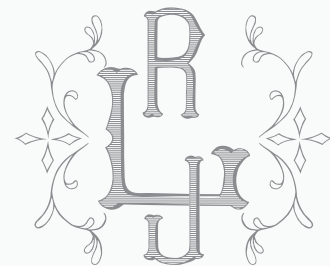

MON257A



MON257B



MON464A



MON464B



MON496A

MONOGRAMS

AVAILABLE THROUGH CONCIERGE ONLY



MON499A



MON499B



MON501A

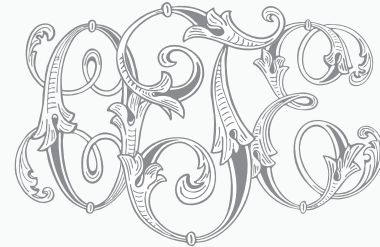

MON506A



MON508A



MON508B



MON508C



MON509A



MON513A



MON513B



MON514A



MON514B



MON514C



MON519A



MON525A



MON525B

MOTIFS



MOT551A



MOT038A



*MOT164A



MOT683A



MOT1067A



MOT174A



MOT108A

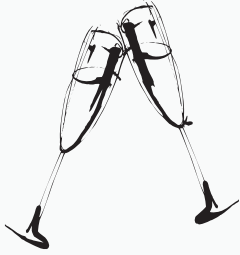

MOT512A



MOT516A



MOT414A



MOT189A



MOT1069A



MOT1068A



MOT380A



MOT516B



MOT1061A



MOT1061B



MOT1062A

W-2023

* Can Be Embossed

Designs will be printed in the size shown, unless specified otherwise.



MOTIFS



MOT661A



*MOT226A



MOT218A



MOT1057A



MOT1051A



MOT1051B



MOT1052A



MOT1052B



MOT1053A



MOT1053B



MOT1054A



MOT1054B



MOT223A



MOT1055A



MOT624A

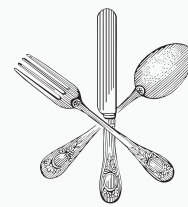

MOT097A



MOT1545A

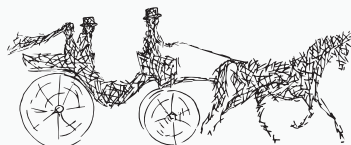

MOT354A



MOT520A



MOT200A



MOT306A



MOT536A



MOT1232A

MOTIFS

W-2023



MOT1091A



MOT1092A



MOT437A



MOT622A



MOT233A



MOT824A



MOT552A



*MOT361C



MOT1489A



MOT443A



MOT508A



MOT1071A



*MOT303B



MOT303A



MOT187A



MOT187B



MOT662A



MOT877A



MOT1143A



MOT1311A



MOT1072A



MOT720A



MOT836A



*MOT844A



MOT076A



*MOT136A



*MOT297A



*MOT297B



*MOT026A



*MOT026B



MOT1000A



MOT1000B



MOT1001A



MOT1001B



MOT1394A













































*MOT298A

* Can Be Embossed

Designs will be printed in the size shown, unless specified otherwise.



MOTIFS

					
MOT615A	MOT489A	*MOT224A	*MOT787A	*MOT159A	*MOT159B
					
*MOT299A	MOT795A	MOT451A	MOT1090A	MOT1090B	*MOT159C
					
*MOT458A	*MOT458C				*MOT481B
					
*MOT458B	*MOT458D	MOT514A	MOT446A	*MOT481A	MOT481C
					
*MOT281A	MOT874A	*MOT889A	*MOT163A	*MOT163B	*MOT208A
					
MOT1515A	MOT1520A	MOT1397A	MOT770A	MOT1155A	MOT1156A
					
MOT778A	MOT778B	MOT780A	MOT779A	MOT779B	MOT1413A

MOTIFS



MOT643A *MOT643B MOT643C MOT157A *MOT157B



MOT212A MOT398A MOT398B *MOT296A MOT296B MOT157C



MOT688A MOT689A MOT797A MOT509A MOT668A MOT528A

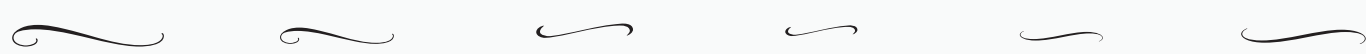

MOT447A MOT447B MOT222A MOT222B MOT1075A MOT1075B



MOT570A MOT040C MOT282A MOT412A



MOT570C MOT040B MOT570D MOT040D

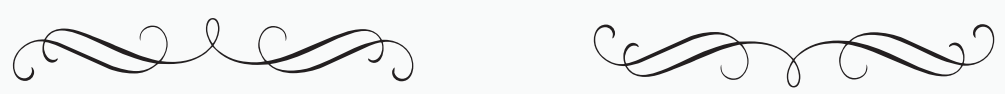

MOT040A MOT570B

W-2023

* Can Be Embossed
 Designs will be printed in the size shown, unless specified otherwise.



MOTIFS



MOT161A

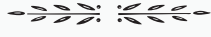

MOT161B



*MOT162A



*MOT731A



MOT789A



MOT789B



MOT788A



MOT121A



*MOT043A



*MOT043B



MOT209A



*MOT046B



MOT771A



MOT869A



*MOT046A



MOT1208A



MOT1209A



MOT1362A



MOT265A



MOT265B



MOT041A

MOTIFS



MOT1298A



MOT1407A



MOT1299A



MOT1300A



MOT1301A



MOT1317A



MOT1318A



MOT1301B



MOT1103A

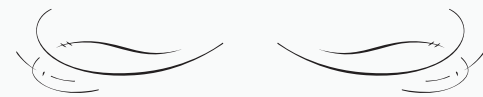

MOT1408A

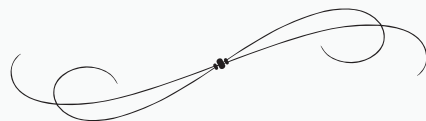

MOT1102A

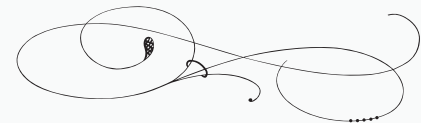

MOT1101A



MOT1404A



MOT1088A

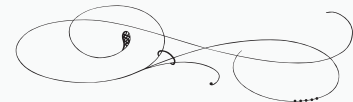

MOT1101B



MOT1404B



MOT1100A



MOT1101C



MOT1303A



MOT1409A



MOT1402A



MOT1315A

W-2023

* Can Be Embossed

Designs will be printed in the size shown, unless specified otherwise.



MOTIFS

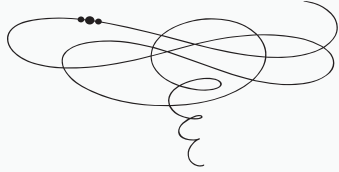

MOT1109A



MOT545A



MOT545B



MOT545C



MOT545D



MOT1182A



MOT897A



MOT898A



MOT1479A



MOT1213A



MOT1357A



MOT1472A



MOT1432A



MOT1492A



MOT1493A



MOT1116A



MOT1116B



*MOT838A



*MOT894A



MOT522A



MOT854A



*MOT211A



*MOT660B



*MOT660A



MOT1080A

MOTIFS



*MOT1081B



MOT1085A



MOT1085B



MOT1086A



MOT1086B



MOT1081A



MOT1085D



MOT1086C



MOT1086D



*MOT269A



*MOT269B

W-2023

* Can Be Embossed

Designs will be printed in the size shown, unless specified otherwise.



MOTIFS

————— BY —————
MOT1307A

————— AND —————
MOT1306A

————— TO —————
MOT1348A

————— TO —————
MOT1342A

————— BY —————
MOT1331A

————— *by* —————
MOT1305A

————— AND —————
MOT1332A

————— *the* —————
MOT1347A

..... TO

MOT1312A

————— *and* —————

MOT1304A

..... AND

MOT1345A

————— *to* —————

MOT1346A

————— TO —————
MOT1340A

————— BY —————
MOT1324A

————— AND —————
MOT1323A

————— THE —————
MOT1343A

————— OF —————
MOT1341A

————— THE —————
MOT1339A

————— to —————
MOT1437A

————— and —————
MOT1438A

MOTIFS



MOT1191A



MOT1189A

YOU'RE INVITED TO A

MOT1261A

SAVE THE DATE

MOT1351A

TOGETHER WITH THEIR FAMILIES

MOT1266A

TOGETHER WITH THEIR PARENTS

MOT1265A

KINDLY DELIVER TO:

MOT1264A

KINDLY RESPOND

MOT1262A

KINDLY REPLY BY

MOT1314A

CELEBRATE WITH US

MOT1358A

TOGETHER WITH THEIR FAMILIES

MOT1295A

TO HAVE AND TO HOLD

MOT1313A

THE FAVOUR OF YOUR RESPONSE

MOT1296A

PLEASE MARK YOUR CALENDAR

MOT1353A

PLEASE JOIN US

MOT1336A

DINNER AND DANCING TO FOLLOW

MOT1354A



MOT1173A



MOT1114A



MOT1322A



MOT1344A



MOT1361A



MOT1297A



MOT1079A



MOT1321A



MOT1316A



MOT1308A



MOT1334A



MOT1352A

W-2023

* Can Be Embossed

Designs will be printed in the size shown, unless specified otherwise.



MOTIFS



MOT1212A



MOT460A



MOT517A



MOT1199A



MOT1252A



MOT1120A



MOT1241A



MOT1104A



MOT1107A



MOT1245A



MOT1132A



MOT1251A



MOT1243A



MOT1246A



MOT1242A



MOT1240A

MOTIFS

Celebrate with us

MOT1244A

Please respond

MOT1133A

Celebration

MOT1135A

Reception

MOT1134A

Celebrate

MOT1105A

Save the Date

MOT1108A

Please Reply

MOT1113A

répondez sil vous plait

MOT1112A

N°

MOT1111A

RSVP

*MOT1327A

CELEBRATE

*MOT1355A

SAVE
THE
DATE

*MOT1356A

RSVP |

*MOT1309A

RSVP

*MOT1310A

W-2023

* Can Be Embossed

Designs will be printed in the size shown, unless specified otherwise.



MOTIFS

Salad

MOT1525A

Entrées

MOT1526A

Dessert

MOT1527A

Details

MOT1477A

bon appétit

MOT1115A

Celebrate

MOT1105A

Table _____

MOT1468A

Table _____

MOT1528A

Table _____

MOT1486A

Cheers!

MOT1032A

Menu

MOT1110A

*You Are
Invited*

MOT1009A

Celebrate!

MOT1020A

MOTIFS

*Save
the Date*

MOT1529A



MOT1399A

Join us

MOT1469A

RSVP

*MOT1425A

Together with their families

MOT1517A

RSVP

*MOT1523A

*Rehearsal
dinner*

MOT1390A

Please Reply

MOT1440A

*MOT1429A BLIND EMBOSS
ONLY

Please reply

MOT1400A

Kindly Respond

MOT1428A

W-2023

* Can Be Embossed

Designs will be printed in the size shown, unless specified otherwise.



MOTIFS

TO
Have
AND TO
Hold

TO
Love
AND TO
Cherish

MOT1329A

MOT1330A

SAVE
THE
DATE

FROM
This Day
FORWARD

*MOT1360A

MOT1350A

MOTIFS

ACCEPTS
WITH PLEASURE

N^o. _____

MOT1510A

DECLINES
WITH REGRET

N^o. _____

R S V P

MOT1513A

◇ *accepts* ◇ *regrets*

MOT1514A

to

MOT1470A

and

MOT1471A

to

MOT1482A

and

MOT1483A

SAVE *the* DATE

MOT1491A

R.S.V.P.

MOT1478A

Kindly Reply

MOT1485A

The favour of a reply is requested

MOT1516A

Reception to follow

MOT1521A

Kindly Respond

MOT1474A

Reception to follow

MOT1509A

Reception

MOT1484A

Response

MOT1467A

Reception to Follow

MOT1473A

The favour of a reply is requested

MOT1481A

Reception immediately following the ceremony

MOT1518A

W-2023

* Can Be Embossed

Designs will be printed in the size shown, unless specified otherwise.

1 inch

MOTIFS

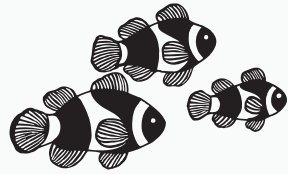

MOT751A



MOT301A



MOT562A



MOT064A



MOT099A

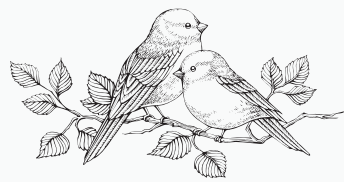

MOT099B



MOT099C



MOT1227A



MOT1286A



MOT302A



MOT103A



MOT710A



MOT710B



MOT711A



MOT014A



MOT273A



MOT1287B

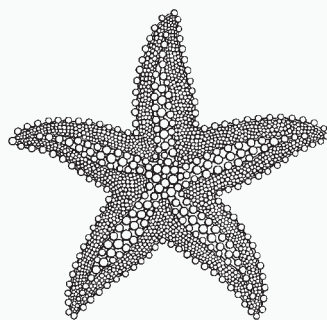

MOT1287A

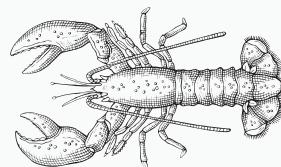

MOT118A

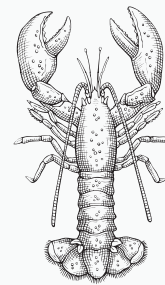

MOT1249A

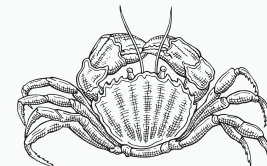

MOT117A

MOTIFS



*MOT135A



*MOT135B



*MOT135C



MOT1094B



*MOT405A



MOT466A



MOT1056A



MOT475A



*MOT134A



*MOT134B

ב"ה

*MOT1123A
BAYS HAY

לחיים

*MOT1128A
L'CHAIM

מזל טוב

*MOT1127A
MAZEL TOV

בס"ד

*MOT1124A
BAYS SAMEKH
DALED

בר מצוה

*MOT1125A
BAR MITZVAH

בת מצוה

*MOT1126A
BAT MITZVAH

W-2023

* Can Be Embossed

Designs will be printed in the size shown, unless specified otherwise.



MOTIFS



MOT312A



MOT313B



MOT313A



MOT310A



MOT017B



MOT707A

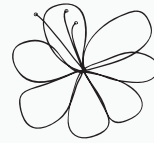

MOT501A

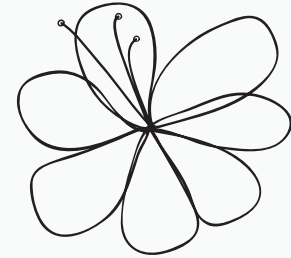

MOT501B



MOT693A



MOT450A

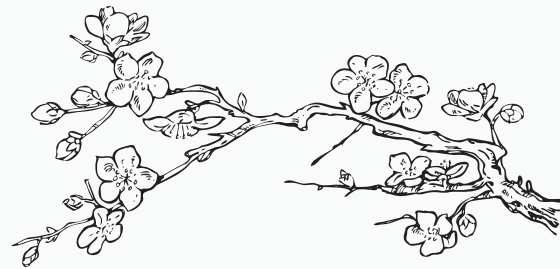

MOT706A



MOT705A

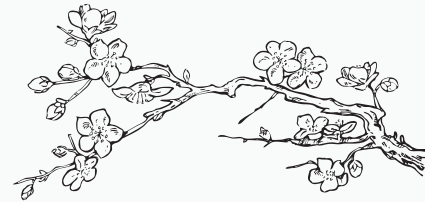

MOT706B



MOT693B



MOT704A



MOT704B

MOTIFS



MOT033A



MOT033B



MOT1333A



MOT1333B



MOT444A

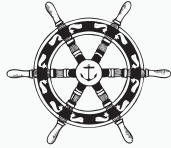

MOT068B



*MOT614A



MOT691A

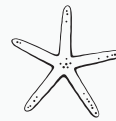

MOT1045A



MOT1046A



MOT1030A

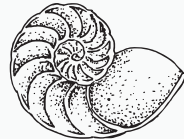

MOT387A



*MOT1047A



MOT072A



MOT471A



MOT746A



MOT746B



MOT746C

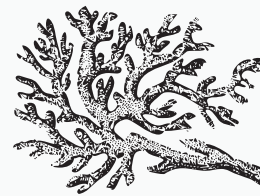

MOT883A



MOT883B



MOT178C



MOT178A



MOT178B



MOT455B



*MOT455A

W-2023

* Can Be Embossed

Designs will be printed in the size shown, unless specified otherwise.



1 inch

MOT746A

MOTIFS

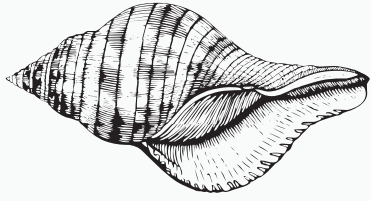

MOT1430A
*MOT1424A BLIND EMOSS ONLY



MOT063A



*MOT116A

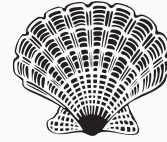

*MOT116B



MOT031A



MOT462A



MOT462B



MOT1044A



MOT453A



MOT453B



MOT1015A

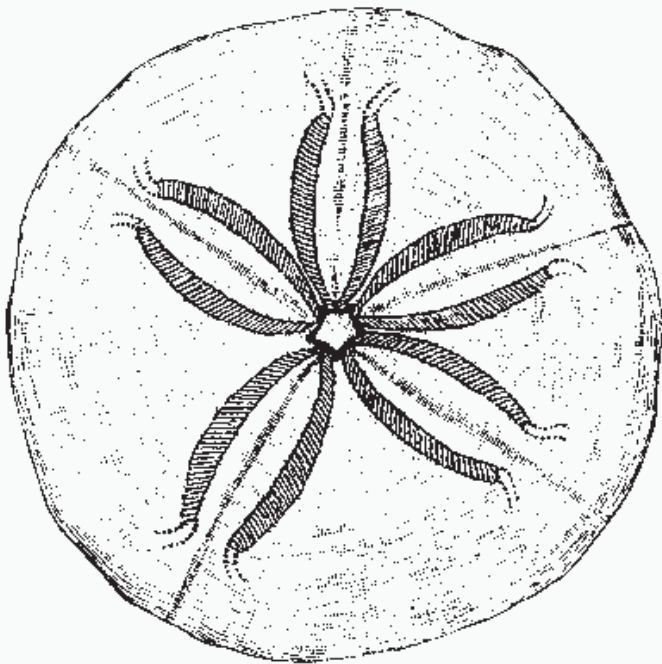

MOT1359A
*MOT1328A BLIND EMOSS ONLY

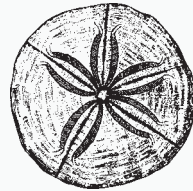

MOT1359D



MOT457A



MOT457B



*MOT047A

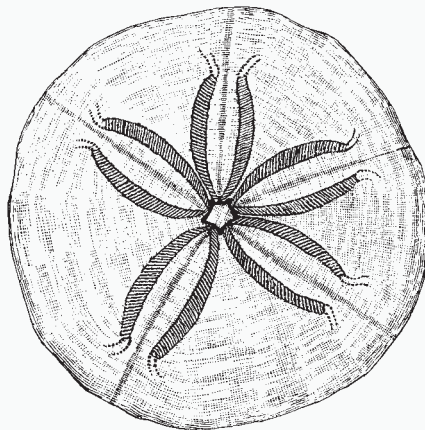

MOT1359C

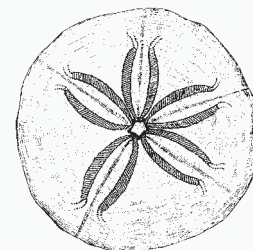

MOT1359B
*MOT1328B BLIND EMOSS ONLY

MOTIFS

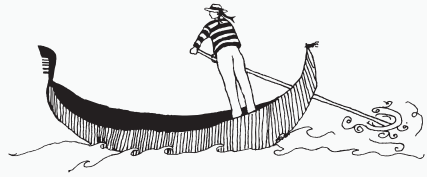

MOT762A



MOT1381A



MOT518A

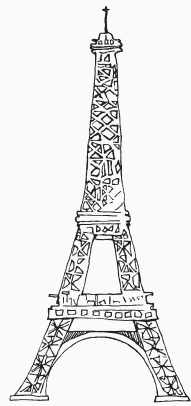

MOT763A

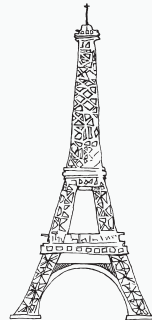

MOT763B

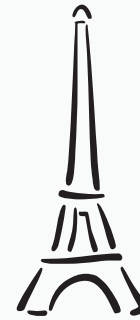

*MOT463A



*MOT470A



MOT753A



MOT806A



MOT742A



MOT1089A

W-2023

* Can Be Embossed

Designs will be printed in the size shown, unless specified otherwise.



MOTIFS

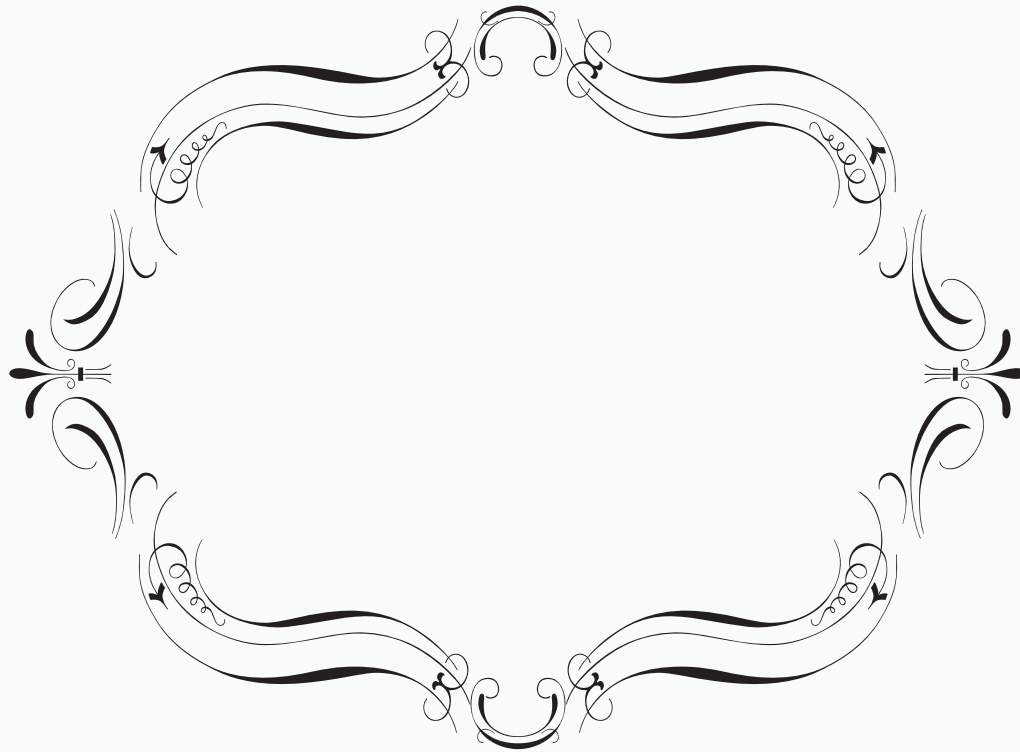

MOT1349A

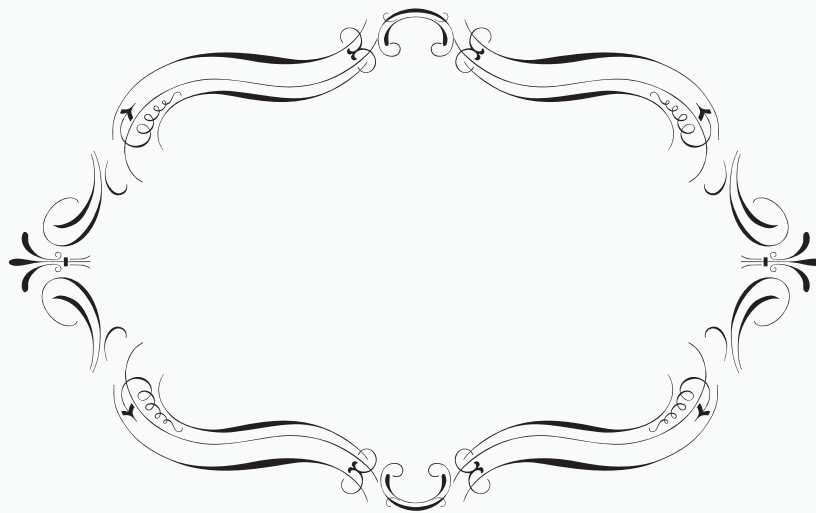

MOT1188A

FRAMES

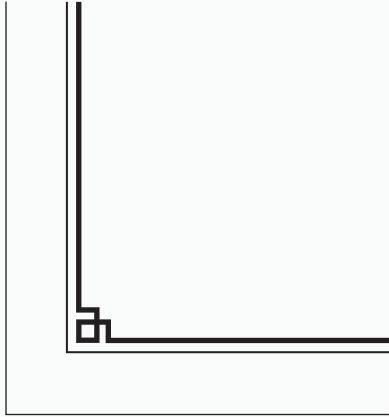

Δ* FRA002

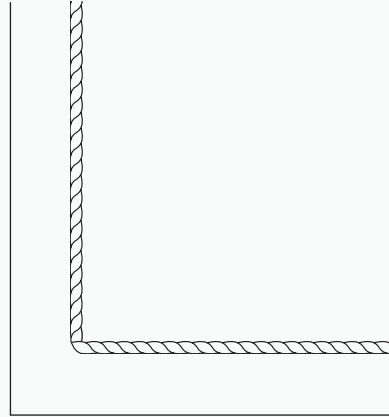

FRA005

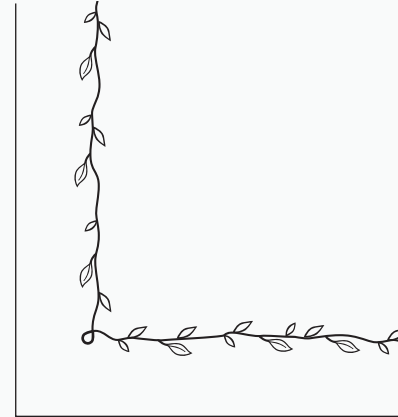

Δ FRA006

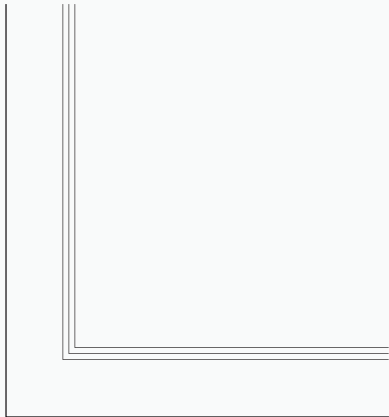

FRA010

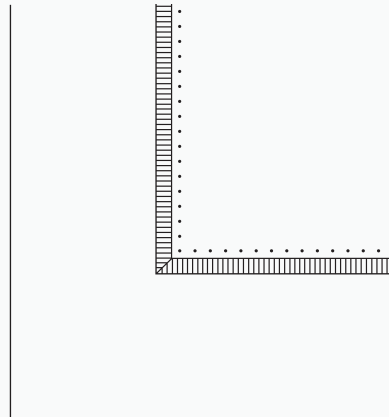

Δ FRA011

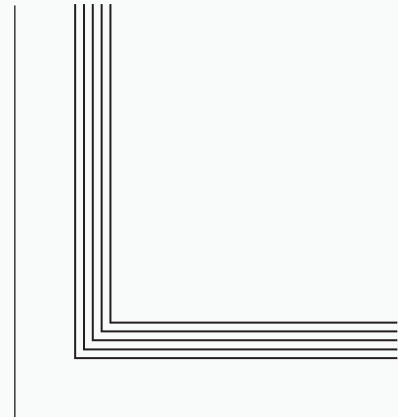

Δ FRA012

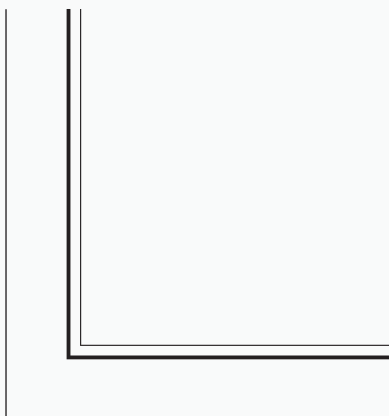

FRA022

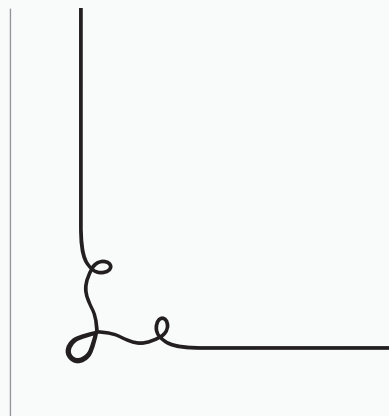

Δ* FRA024

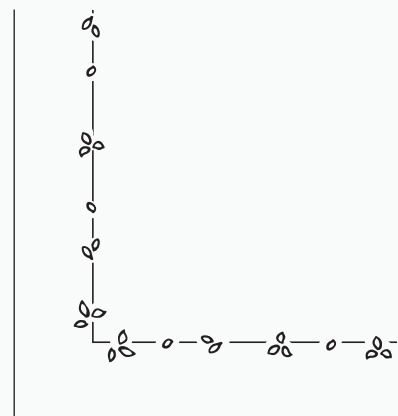

FRA042

W-2023

* Can Be Embossed

Designs will be printed in the size shown, unless specified otherwise.



FRAMES

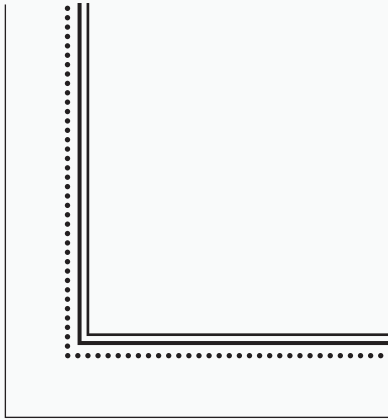

△ FRA013

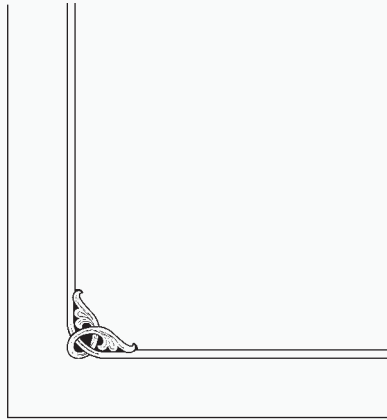

△ FRA007

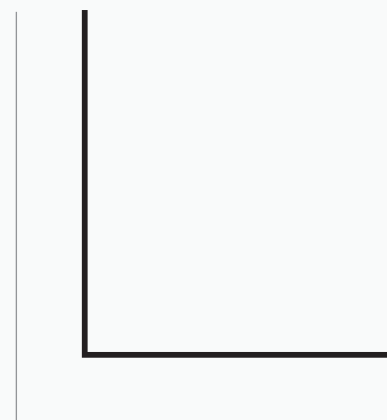

* FRA026

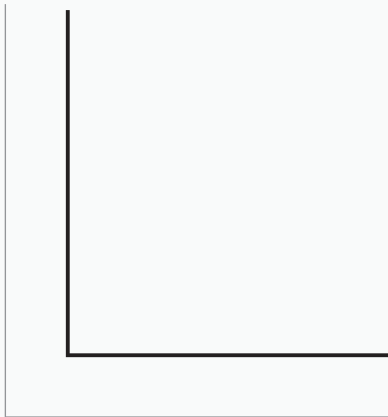

FRA023

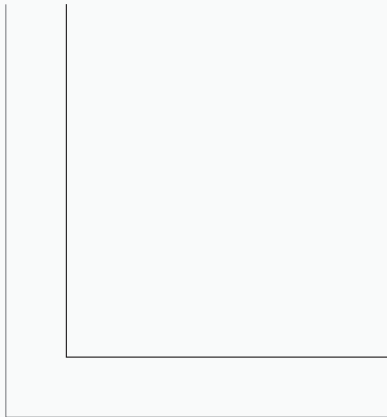

FRA028

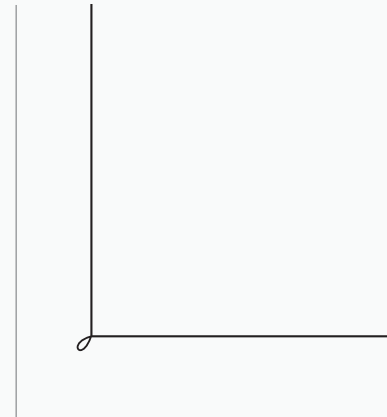

FRA025

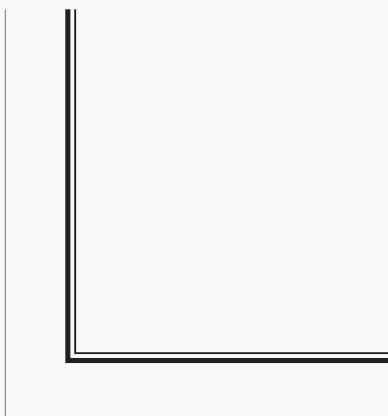

FRA027

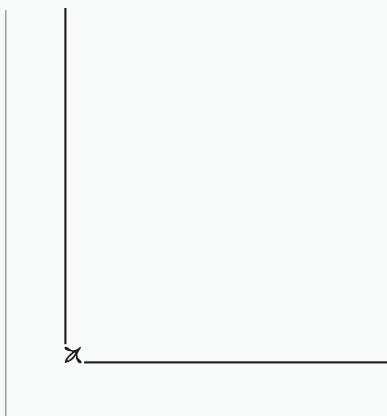

FRA030

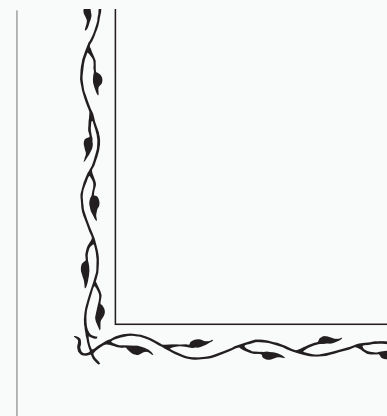

FRA031

FRAMES

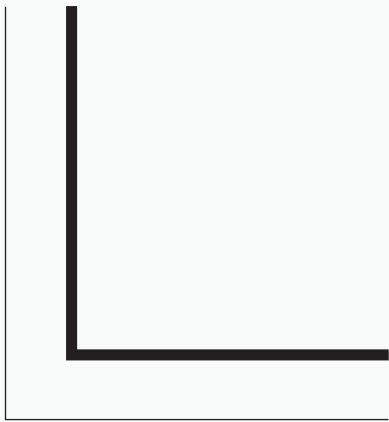

* FRA034

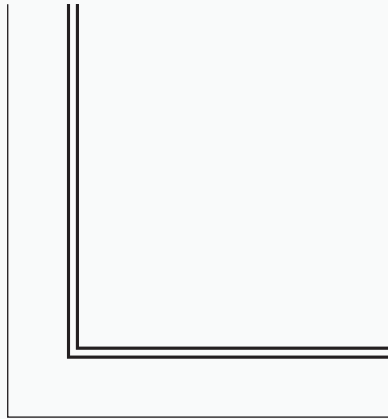

FRA035

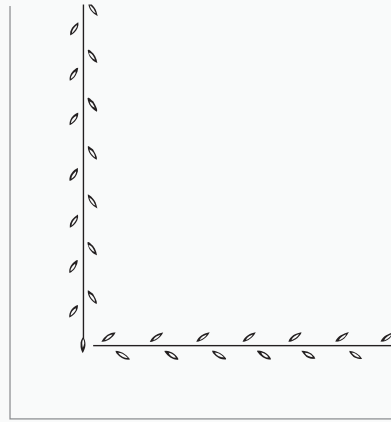

FRA036



FRA039



FRA029

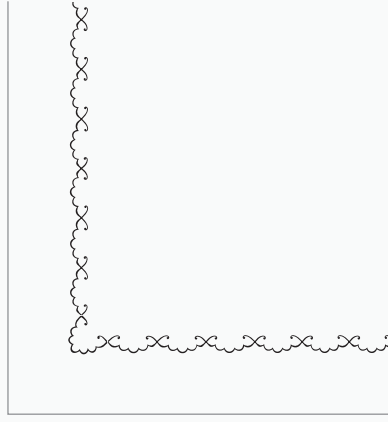

FRA043

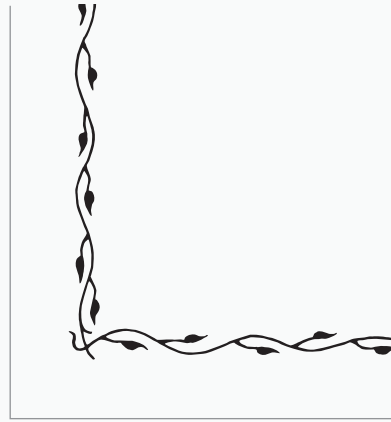

FRA037

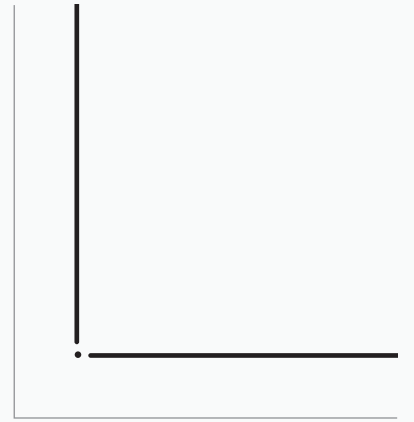

FRA040

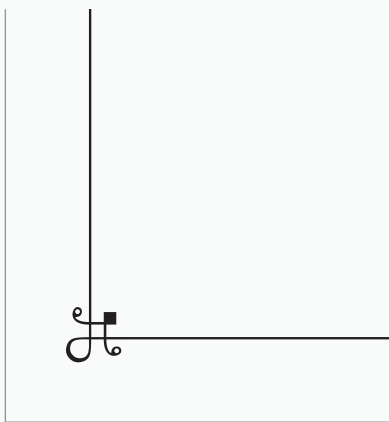

Δ FRA032

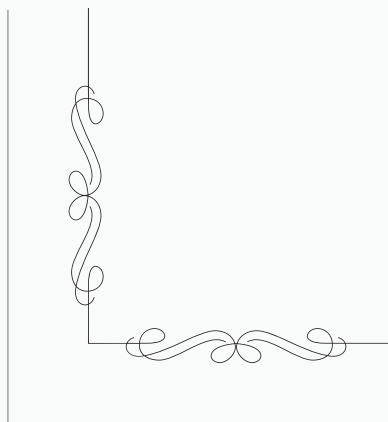

FRA038

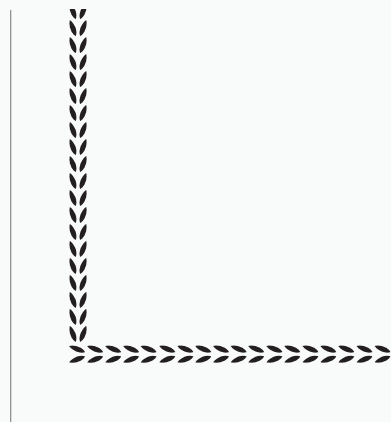

Δ FRA033

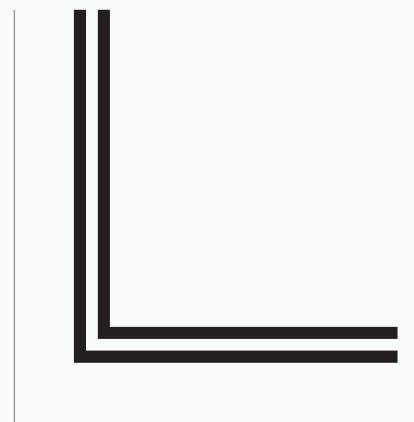

* FRA041

W-2023

* Can Be Embossed

Designs will be printed in the size shown, unless specified otherwise.



FRAMES

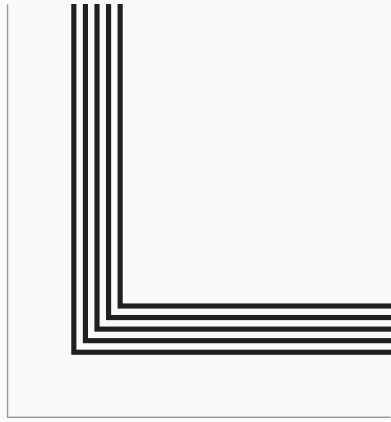

Δ* FRA1236



FRA1238

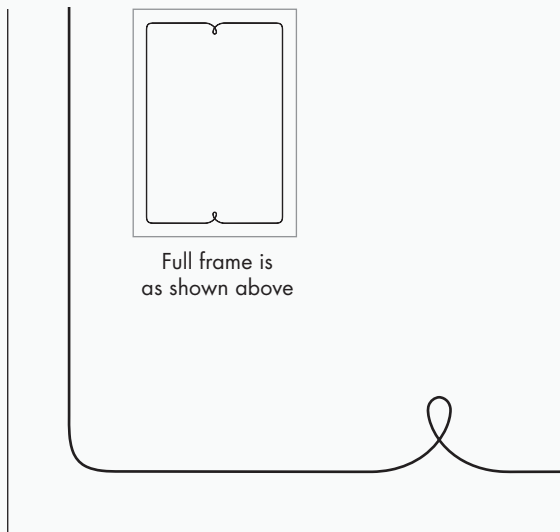

Δ FRA014

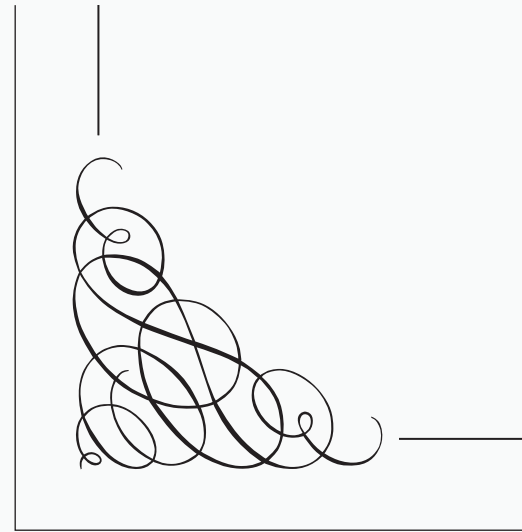

Δ FRA018

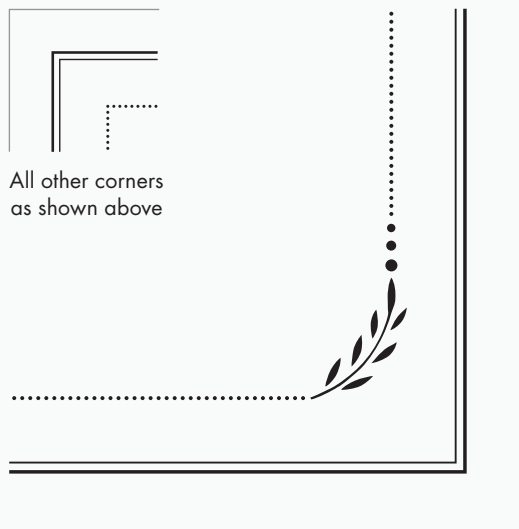

Δ FRA015

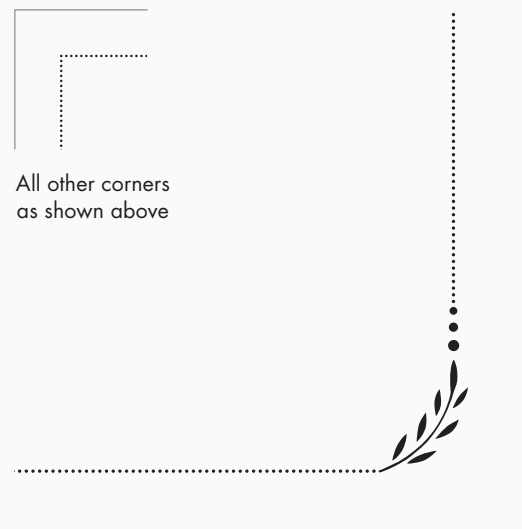

Δ FRA021

Crane

CRANE STATIONERY
461 SARATOGA STREET
COHOES, NY 12047

PHONE (877) 478 4849