

WEDDING

Crane



Crane

WEDDINGS

First impressions are everything, and the introduction to your Big Day is no exception. Choosing the right wedding invitation does so much more than give your guests the vital information they need to attend: it sets the tone for the wedding itself.

Whether your style is contemporary, classic, or somewhere in between, your invitation should reflect the personality of your ceremony and reception. It is a statement about who you are as a couple, a chance to express your joint style and character—the essence of what makes your partnership unique.

Like you, we want every detail of your wedding to be perfect. That's why we believe in meticulously handcrafting every piece on the finest pure cotton paper. Honed from one generation to the next, our craftsmanship is the signature of Crane's legendary quality, ensuring your invitation will be treasured for decades.

THE PRESSES, THE PROCESSES, THE PEOPLE



Before the telegraph, typewriter and telephone, Crane was in the business of communication. Originating from the beautiful Berkshire Mountains of Western Massachusetts, Crane has been making luxury products for more than 200 years.

Our 100% cotton papers are still made from reclaimed cotton fibers. Cotton papers are exquisitely soft, durable, and archival. This means that your wedding invitation will look as good on your Golden Anniversary as it does on the day you say “I Do”.

Our paper is the perfect canvas for our specialty printing and embellishments. From engraving, letterpress printing, and blind embossing to thermography, flat and digital printing—we do it all, and we do it well.

Our artisans also specialize in the arts of gilding with silver and gold foil, edge painting, and much more. We are craftsmen and women who handle the details, one piece of paper at a time.

Crane



AVIGNON FRENCH FOLD SUITE

PAPER CODE	DESCRIPTION	WEIGHT	PRICE GROUP
59-LN1116	NOTE	32#	V
59-LE1116	NOTE ENVELOPE	32#	V
59-LC3116	ANNOUNCEMENT CARD (shown 2 color)	96#	R
59-LE3116	ANNOUNCEMENT ENVELOPE (not shown)	32#	R

DESIGN ELEMENTS

Lettering	LET712
Monogram	MON206A (on note) MON206B (on announcement)
Inks	GOLD CHARCOAL
Process	ENGRAVING
Lining	LIN443E Metallic Gold (additional - price group HH)
Paper	ECRU KID FINISH®

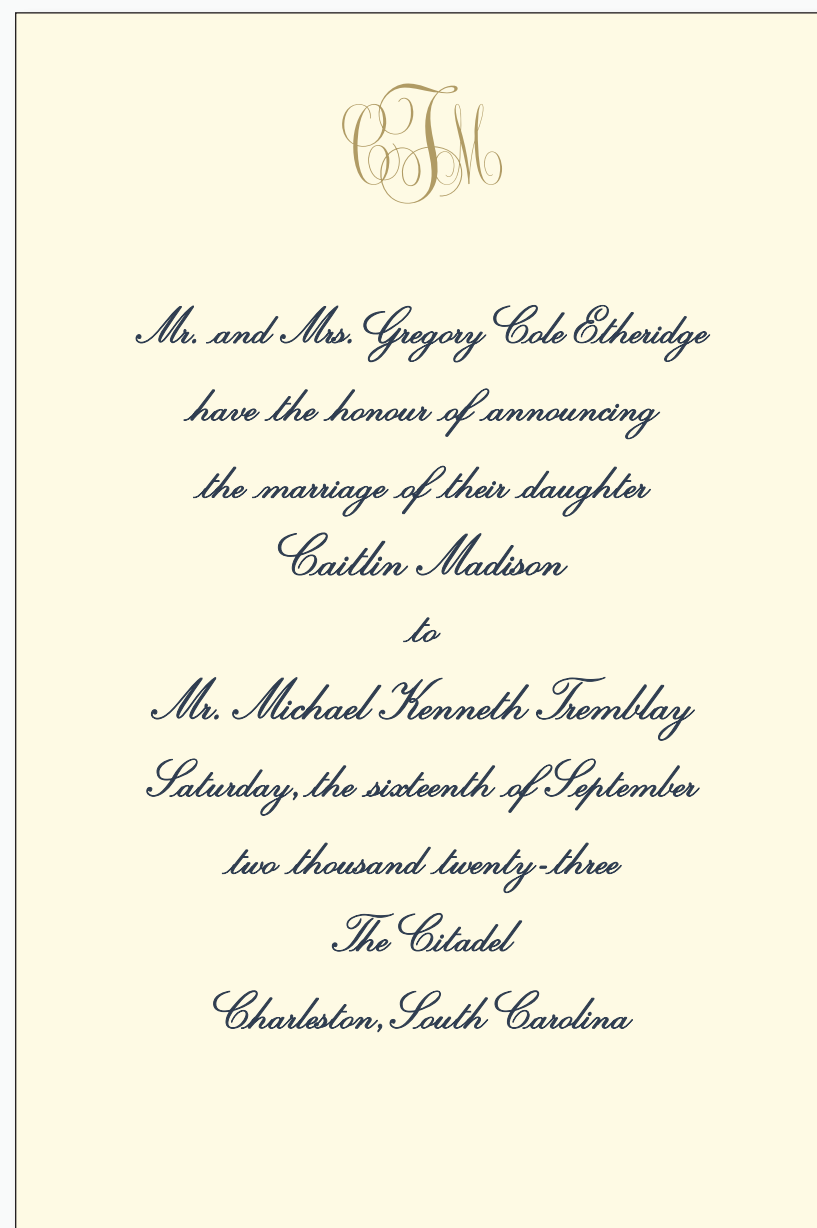

AVIGNON FRENCH FOLD SUITE

PAPER CODE	DESCRIPTION	WEIGHT	PRICE GROUP
59-LC3116	REHEARSAL DINNER CARD	96#	R
59-LE3116	REHEARSAL DINNER ENVELOPE (not shown)	32#	R
59-T84-124	PLACE CARD	64#	EE
59-LC1116	ACCOMMODATION CARD	96#	AA

DESIGN ELEMENTS	
Lettering	LET712
Monogram	MON206B
Motif	MOT1402A Loopy Swash
Inks	CHARCOAL GOLD
Process	ENGRAVING
Paper	ECRU KID FINISH®

Doctor and Mrs. Stephen Tremblay

invite you to join them for a

Rehearsal Dinner

in honor of

Caitlin and Michael

Friday, September fifteenth

at seven o'clock

The Harbour Club

25 Piquet Street

Charleston

*R.s.v.p. by September fifth
to stremblay@email.com*

CSM

Details and Accommodations



*For travel details, accommodations and
a complete list of wedding weekend festivities*

please visit

www.caitlinandmichaelwedding.com

Within the Ribbon



*Please present this card at
Summerall Chapel*

Reception
immediately following the ceremony

The William Aiken House

456 King Street
Charleston

Mr. and Mrs. Gregory Etheridge
Twelve Oaks Drive
Charleston, South Carolina 29414



*The favour of a reply is requested
before the twenty-eighth of August*

AVIGNON FRENCH FOLD SUITE

PAPER CODE	DESCRIPTION	WEIGHT	PRICE GROUP
59-V31-130	WITHIN THE RIBBON CARD	96#	EE
59-LC1116	RECEPTION CARD	96#	E
59-LC1116	RESPONSE CARD (shown 2 color)	96#	E
59-LE1116	RESPONSE ENVELOPE	32#	E

DESIGN ELEMENTS

Lettering	LET712
Monogram	MON206B
Motif	MOT1402A Loopy Swash
Inks	CHARCOAL GOLD
Process	ENGRAVING
Paper	ECRU KID FINISH®

W-2022

*Twelve Oaks Drive
Charleston, South Carolina 29414*



*Mr. and Mrs. Gregory Cole Etheridge
request the honour of your presence
at the marriage of their daughter
Caitlin Madison
to
Michael Kenneth Tremblay
Saturday, the sixteenth of September
two thousand twenty-three
at half after five o'clock
Summerall Chapel
The Citadel
Charleston, South Carolina*

Black tie

PLEASE NOTE:

- French Fold invitations are available engraved only and may require additional postage.

AVIGNON FRENCH FOLD SUITE • PRICE GROUP E

PAPER CODE	DESCRIPTION	WEIGHT
59-W88	EMBASSY FRENCH FOLD WEDDING SHEET (shown 2 color)	40#
59-W65	INSIDE ENVELOPE (ungummed)	32#
59-W85	OUTSIDE ENVELOPE	32#
59-LE9116	SINGLE ENVELOPE (not shown)	32#

DESIGN ELEMENTS

Lettering	LET712
Monogram	MON206B
Inks	GOLD CHARCOAL
Process	ENGRAVING
Lining	LIN443E Metallic Gold (additional - price group HH)
Paper	ECRU KID FINISH®

Join us

Friday, August 1st

WELCOME LIBATIONS
HOSTED BY MARY AND TED CONNOLLY
9:00 PM - 11:00 PM
THE SILVER SPOON

Sunday, August 1st

FAREWELL BRUNCH
10:00 AM - 12:00 PM
ROCHESTER BRUNCH HOUSE

FOR ADDITIONAL DETAILS
PLEASE VISIT OUR WEBSITE
AMANDAANDTYLER.COM

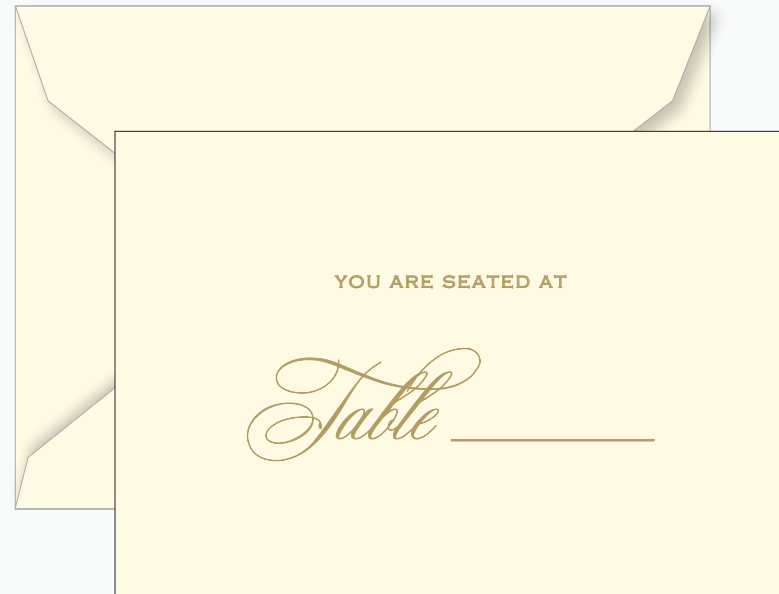

DARCY SUITE

PAPER CODE	DESCRIPTION	WEIGHT	PRICE GROUP
59-LC1116	RESPONSE/RECEPTION CARD	96#	A
59-LE1116	RESPONSE ENVELOPE (not shown)	32#	A
59-V31-130	TABLE CARD	96#	EE
59-E82-130	TABLE CARD ENVELOPE	32#	EE
59-LC1116	EVENT CARD	96#	AA

DESIGN ELEMENTS

Lettering	LET510 (block) LET728 (script)
Motifs	MOT1467A Response MOT1090B Square MOT1468A Table MOT1469A Join Us
Ink	GOLD
Process	THERMOGRAPHY
Paper	ECRU KID FINISH®

PLEASE NOTE:

- See Motif Chart for alternate word motifs

Response

KINDLY RESPOND BY
THE TWENTY-THIRD OF JULY

M _____

ACCEPTS WITH PLEASURE

PLEASE INDICATE THE NUMBER
OF GUESTS ATTENDING

_____ WELCOME LIBATIONS

_____ FAREWELL BRUNCH

DECLINES WITH REGRET

Twenty-five Camelot Way

ROCHESTER, MICHIGAN

48306

*Amanda
and
Tyler*

MR. AND MRS. PAUL JASON BRENNER
REQUEST THE PLEASURE OF YOUR COMPANY
AT THE MARRIAGE OF THEIR DAUGHTER

AMANDA HALEY

to

TYLER BLAKE CONNOLLY

SATURDAY, THE TWELFTH OF AUGUST
TWO THOUSAND TWENTY-THREE
AT FOUR O'CLOCK IN THE AFTERNOON
MEADOW BROOK HALL
ROCHESTER, MICHIGAN

RECEPTION IMMEDIATELY FOLLOWING

PLEASE NOTE:

- Embassy invitations may require additional postage.

DARCY SUITE • PRICE GROUP A

PAPER CODE	DESCRIPTION	WEIGHT
59-LC9116	EMBASSY INVITATION	96#
59-W65	INSIDE ENVELOPE (ungummed)	32#
59-W85	OUTSIDE ENVELOPE	32#
59-LE9116	SINGLE ENVELOPE (not shown)	32#

DESIGN ELEMENTS

Lettering	LET728 (script), LET510 (block), LET606 (large block)
Motif	MOT1470 swash to
Ink	GOLD
Process	THERMOGRAPHY
Lining	LIN200C Gold Leaves on Green (additional - price group HH)
Paper	ECRU KID FINISH®

WELCOME DINNER

*Friday, the sixth of October
six o'clock*

*Please join us for a casual evening with
dinner, cocktails and socializing*

*Bear Republic Brewing Co
345 Healdsburg Avenue
Healdsburg, California*

MENU

Angie and Samuel

HEALDSBURG COUNTRY GARDENS

OCTOBER 7, 2023



Wild Arugula Salad

WITH SHAVED PARMESAN
PEPITAS & SHERRY VINAIGRETTE

Filet Mignon

WITH CHIMICHURI SAUCE

Marinated Grilled Chicken Breast

WITH MUSHROOMS AND PEPPER

Grilled Salmon

WITH ROASTED CORN RELISH

Mini Pies with Seasonal Fruit

PETALUMA COFFEE & TEA

ISABELLE SUITE

PAPER CODE	DESCRIPTION	WEIGHT	PRICE GROUP
59-LC1111	EVENT CARD	96#	AA
59-LC3111	MENU CARD	96#	R
59-LC1111	RESPONSE/RECEPTION CARD	96#	A
59-LE1111	RESPONSE ENVELOPE (not shown)	32#	A

DESIGN ELEMENTS

Lettering	LET511 (block, shown in all caps with letter spacing added) LET716 (script)
Motif	MOT1116B Calligraphy Flourish
Ink	FRENCH BLUE
Process	ENGRAVING
Paper	PEARL WHITE KID FINISH®

PLEASE REPLY
BY THE EIGHTEENTH OF SEPTEMBER

M _____

_____ *delighted to attend*

_____ *regretfully decline*

_____ *will attend the Welcome Dinner*

*Doctor and Mrs. Augustine Coletta
request the pleasure of your company
at the marriage of their daughter*

ANGELA LYNNE

to

SAMUEL JOSEPH LANSING

son of Mr. and Mrs. William Lansing

Saturday, seventh of October

two thousand twenty-three

at three o'clock

Healdsburg Country Gardens

Healdsburg, California



RECEPTION TO FOLLOW



820 PALMDALE COURT
PLEASANTON, CALIFORNIA 94588

PLEASE NOTE:

- Embassy invitations may require additional postage.

ISABELLE SUITE • PRICE GROUP A

PAPER CODE	DESCRIPTION	WEIGHT
59-LC9111	EMBASSY INVITATION	96#
59-W60	INSIDE ENVELOPE (UNGUMMED)	32#
59-W80	OUTSIDE ENVELOPE	32#
59-LE9111	SINGLE ENVELOPE (not shown)	32#

DESIGN ELEMENTS

Lettering	LET716 (script) LET511 (block, shown all caps with letter spacing added)
Motif	MOT1116B Calligraphy Flourish
Ink	FRENCH BLUE
Process	ENGRAVING
Lining	LIN444J Florentine Garden (additional - price group HH)
Paper	PEARL WHITE KID FINISH®

Reception to Follow

THE BELLE HAVEN CLUB
100 HARBOR DRIVE
GREENWICH



Kindly Respond

BEFORE THE TWENTY-EIGHTH OF AUGUST

M _____

_____ *accepts* WITH PLEASURE

_____ *declines* WITH REGRET



JHM

ESSEX SUITE

PAPER CODE	DESCRIPTION	WEIGHT	PRICE GROUP
59-LC1116	RECEPTION CARD (shown 2 color)	96#	H
59-LC1116	RESPONSE CARD	96#	H
59-LE1116	RESPONSE ENVELOPE (not shown)	32#	H
59-LF1116	HEAVYWEIGHT NOTE (shown 2 color)	64#	W
59-LE1116	NOTE ENVELOPE	32#	W

DESIGN ELEMENTS

Lettering	LET506S (block) LET704W (swash) LET704
Monogram	MON439A
Motifs	MOT1473A Reception to Follow MOT1472A Floral Ornament MOT1474A Kindly Respond
Inks	GOLD NAVY
Process	ENGRAVING
Lining	LIN443E Metallic Gold (additional - price group HH)
Paper	ECRU KID FINISH®

PLEASE NOTE:

- See Motif Chart for alternate word motifs



TOGETHER WITH THEIR FAMILIES

Kathryn Joanne Bellemore
and
Michael Stephen Hadley

REQUEST THE HONOUR OF YOUR PRESENCE
AS THEY EXCHANGE MARRIAGE VOWS

SATURDAY, THE SIXTEENTH OF SEPTEMBER
TWO THOUSAND TWENTY-THREE
AT ELEVEN O'CLOCK IN THE MORNING



THE FIRST PRESBYTERIAN CHURCH
GREENWICH, CONNECTICUT

34 Bayberry Lane
GREENWICH, CONNECTICUT 06831

PLEASE NOTE:
• Royalty invitations will require additional postage.

W-2022

ESSEX SUITE • PRICE GROUP H

PAPER CODE	DESCRIPTION	WEIGHT
59-LC0106	ROYALTY INVITATION (shown 2 color)	96#
59-W17	INSIDE ENVELOPE (ungummed)	32#
59-W37	OUTSIDE ENVELOPE	32#
59-LE0116	SINGLE ENVELOPE (not shown)	32#

DESIGN ELEMENTS

Lettering	LET506S (block), LET704W (swash), LET704 (script)
Monogram	MON439C
Motif	MOT1472A Floral Ornament
Inks	GOLD NAVY
Process	ENGRAVING
Lining	LIN131A Navy (additional - price group HH)
Paper	ECRU KID FINISH®

MR. AND MRS. CLARK L BAUER
 28 ROSEWOOD COURT
 BRIDGEWATER, NEW JERSEY 08807

CLB

WILL _____ ATTEND

THE FAVOR OF A REPLY IS REQUESTED
 BEFORE THE FIRST OF JULY

Reception

AT FIVE O'CLOCK
 CONGRESS HALL
 200 CONGRESS PLACE
 CAPE MAY, NEW JERSEY

BLACK TIE

NEWPORT SUITE • PRICE GROUP H

PAPER CODE	DESCRIPTION	WEIGHT
59-LC1116	RESPONSE CARD	96#
59-LE1116	RESPONSE ENVELOPE	32#
59-LC1322	BEACH GLASS RECEPTION CARD	96#

DESIGN ELEMENTS

Lettering	LET606 (block) LET714 (script)
Monogram	MON542A
Ink	GOLD
Process	ENGRAVING
Paper	ECRU KID FINISH® BEACH GLASS KID FINISH®

W-2022



MR. AND MRS. CLARK LUNDEN BAUER
 AND
 MR. AND MRS. KENNETH PAUL CRAMWELL
 REQUEST THE HONOUR OF YOUR PRESENCE
 AT THE MARRIAGE OF THEIR DAUGHTER

CHELSEA JEANNE

to

BRETT EDWARD WHETHERBY

SON OF MR. AND MRS. CHAD NATHANIEL WEATHERBY
 SATURDAY, THE TWENTY-SECOND OF JULY
 TWO THOUSAND TWENTY-THREE
 AT HALF AFTER ONE O'CLOCK

CHURCH OF OUR LADY STAR OF THE SEA
 CAPE MAY, NEW JERSEY

28 ROSEWOOD COURT
 BRIDGEWATER, NEW JERSEY 08807

PLEASE NOTE:

- Royalty invitations will require additional postage.
- Double Envelopes are not available for colored papers.

NEWPORT SUITE • PRICE GROUP H

PAPER CODE	DESCRIPTION	WEIGHT
59-LC0322	ROYALTY BEACH GLASS INVITATION	96#
59-LE0322	BEACH GLASS SINGLE ENVELOPE	32#

DESIGN ELEMENTS

Lettering	LET606 (block), LET714 (script)
Monogram	MON542A
Motif	MOT1075A Flourish
Ink	GOLD
Process	ENGRAVING
Paper	BEACH GLASS KID FINISH®

DOVER SUITE • PRICE GROUP N

PAPER CODE	DESCRIPTION	WEIGHT
59-LC1446	PREMIUM WEIGHT STATELY CORNERS ACCOMMODATION CARD	192#
59-LC1446	PREMIUM WEIGHT STATELY CORNERS RESPONSE/RECEPTION CARD	192#
59-LE1116	RESPONSE ENVELOPE	32#

DESIGN ELEMENTS

Lettering	LET506S (block)
	LET728 (script)
Motifs	MOT1477A Details
	MOT1479A Swash
	MOT1478A R.S.V.P.
Ink	BLACK
Process	ENGRAVING
Paper	ECRU KID FINISH®

PLEASE NOTE:

- Premium Weight papers are reserved for engraving and letterpress only.
- Premium Weight Stately Corners Card orders will require 14 business days once order is received or final proof is approved, in addition to the printing process turn time.

Details

A BLOCK OF ROOMS HAS BEEN RESERVED
AT THE FOLLOWING HOTELS:

HILTON GARDEN INN
LAKE FOREST METTAWA
RESIDENCE INN CHICAGO
LAKE FOREST METTAWA

PLEASE REFERENCE
THE HALPERIN/BERNS WEDDING AND
MAKE YOUR RESERVATIONS BY AUGUST 23.

OPTIONAL TRANSPORTATION WILL BE
PROVIDED TO AND FROM THE ARMOUR HOUSE
AND FROM THE ABOVE HOTELS.

*For directions and other information
please visit:*

WWW.OLIVIAANDJOSHWED.COM

Mr. and Mrs. Raymond Halperin

384 WEST ERIE STREET

NUMBER 204

CHICAGO, ILLINOIS

60654

R.S.V.P.

BEFORE THE TWENTY-FIRST OF AUGUST

M _____

_____ *accepts with pleasure* _____ *declines with regret*

PLEASE NOTE:

- Royalty invitations will require additional postage.
- Premium Weight papers are reserved for engraving and letterpress only.
- Premium Weight Stately Corners Card orders will require 14 business days once order is received or final proof is approved, in addition to the printing process turn time.

*Mr. and Mrs. Raymond Peter Halperin
request the honour of your presence
at the marriage of their daughter*

Mirvia Stephanie

to

Joshua Robert Berns

*Sunday, the tenth of September
two thousand twenty-three
at half after five o'clock in the afternoon*

*The Armour House
Lake Forest, Illinois*

Dinner and Dancing to follow

384 WEST ERIE STREET • NUMBER 204
Chicago, Illinois 60654

W-2022

DOVER SUITE • PRICE GROUP N

PAPER CODE	DESCRIPTION	WEIGHT
59-LCR0446	ROYALTY PREMIUM WEIGHT STALEY CORNERS INVITATION	192#
59-W17	INSIDE ENVELOPE (ungummed)	32#
59-W37	OUTSIDE ENVELOPE	32#
59-LE0116	SINGLE ENVELOPE (not shown)	32#

DESIGN ELEMENTS

Lettering	LET728 LET506S (block on envelope)
Ink	BLACK
Process	ENGRAVING
Lining	LIN099D Linen Gold (additional - price group HH)
Paper	ECRU KID FINISH®

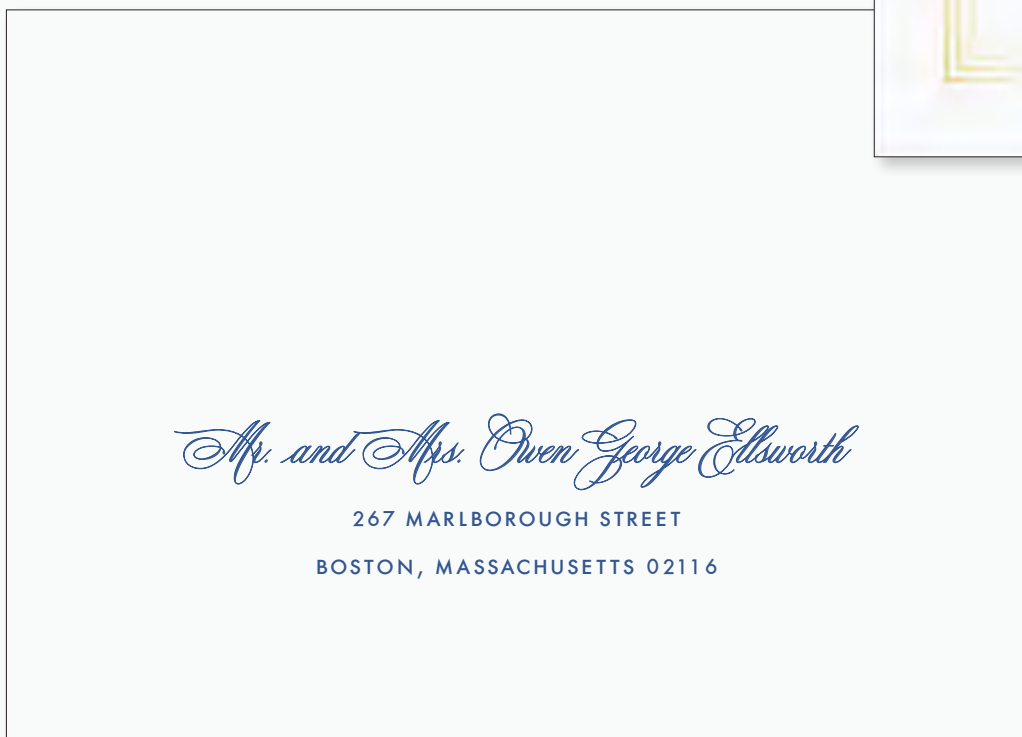
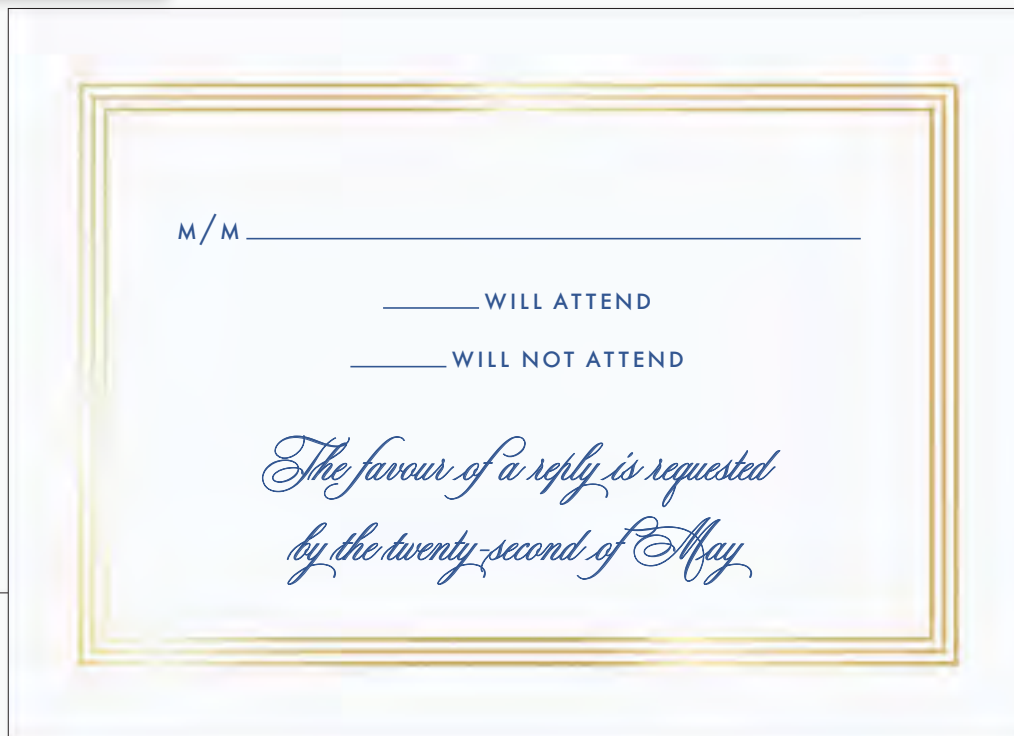

CAMBRIDGE SUITE • PRICE GROUP I

PAPER CODE	DESCRIPTION	WEIGHT
59-LC1871	GOLD TRIPLE BORDER FRAME RECEPTION CARD	96#
59-LC1871	GOLD TRIPLE BORDER FRAME RESPONSE CARD	96#
59-LE1111	RESPONSE ENVELOPE	32#

DESIGN ELEMENTS

Lettering	LET609S (block) LET728 (script)
Motif	MOT1484A Reception
Ink	REGENT BLUE
Process	THERMOGRAPHY
Paper	PEARL WHITE KID FINISH®

267 MARLBOROUGH STREET
BOSTON, MASSACHUSETTS 02116



MR. AND MRS. OWEN GEORGE ELLSWORTH & MR. AND MRS. BRADFORD JAMES ETHERIDGE
REQUEST THE HONOUR OF YOUR PRESENCE AT THE MARRIAGE OF THEIR CHILDREN

Hannah Grace & Andrew John

SATURDAY, THE SEVENTEENTH OF JUNE, TWO THOUSAND TWENTY-THREE
AT HALF AFTER FIVE O'CLOCK

BASILICA OF OUR LADY OF PERPETUAL HELP
1545 TREMONT STREET
BOSTON, MASSACHUSETTS

W-2022

CAMBRIDGE SUITE • PRICE GROUP I

PAPER CODE	DESCRIPTION	WEIGHT
59-LC0871	GOLD TRIPLE BORDER FRAME ROYALTY INVITATION (shown 2 color)	96#
59-W13	INSIDE ENVELOPE (ungummed)	32#
59-W33	OUTSIDE ENVELOPE	32#
59-LE0111	SINGLE ENVELOPE (not shown)	32#

DESIGN ELEMENTS

Lettering	LET609S (block), LET728 (script)
Monogram	MON455B
Inks	GOLD REGENT BLUE
Process	THERMOGRAPHY
Lining	LIN009A Regent Blue (additional - price group HH)
Paper	PEARL WHITE KID FINISH®

PLEASE NOTE:

- Gold Triple Border Frame Royalty invitations will require additional postage.



EMMA SUITE

PAPER CODE	DESCRIPTION	WEIGHT	PRICE GROUP
59-C1116PRL	PEARL BORDERED RESPONSE/RECEPTION CARD	96#	C
59-LE1116	RESPONSE ENVELOPE (not shown)	32#	C
59-V31-130	TABLE CARD	96#	EE
59-E82-130	TABLE CARD ENVELOPE	32#	EE
59-LF1116	HEAVYWEIGHT NOTE	64#	W
59-LE1116	NOTE ENVELOPE	32#	W

DESIGN ELEMENTS

Lettering	LET606 (block) LET705 (script)
Motifs	MOT545A Flourish
Ink	PEWTER
Process	THERMOGRAPHY
Lining	LIN391B Pearl Stripe (additional - price group HH)
Paper	ECRU KID FINISH®



426 MOUNT VERNON STREET
PHILADELPHIA, PENNSYLVANIA 19130



Lauren Jayne Hardy
and
Jonathan Mark Warren

REQUEST THE PLEASURE OF YOUR COMPANY
AT THE CELEBRATION OF THEIR MARRIAGE
FRIDAY, THE TWENTY-FOURTH OF JUNE
TWO THOUSAND TWENTY-THREE
AT FIVE O'CLOCK

Knottton Mansion
PHILADELPHIA, PENNSYLVANIA



RECEPTION IMMEDIATELY FOLLOWING

BLACK TIE INVITED

W-2022

PLEASE NOTE:

- Embassy invitations may require additional postage.

EMMA SUITE • PRICE GROUP C

PAPER CODE	DESCRIPTION	WEIGHT
59-C9116PRL	EMBASSY PEARL BORDERED INVITATION	96#
59-W65	INSIDE ENVELOPE (ungummed)	32#
59-W85	OUTSIDE ENVELOPE	32#
59-LE9116	SINGLE ENVELOPE (not shown)	32#

DESIGN ELEMENTS

Lettering	LET705 (script) LET606 (block)
Motif	MOT545A Flourish
Ink	PEWTER
Process	THERMOGRAPHY
Lining	LIN278B Champagne Shimmer (additional - price group HH)
Paper	ECRU KID FINISH®

Kindly reply before September seventeenth

*Elena and Benjamin Adamson
842 Dunvegan Road
Toronto, Ontario
M5P 2P2*

*Valet Parking
The Royal Ontario Museum
Bloor Street Entrance*

WARWICK SUITE

PAPER CODE	DESCRIPTION	WEIGHT	PRICE GROUP
59-LC1116	RECEPTION/RESPONSE CARD	96#	E
59-LE1116	RESPONSE ENVELOPE (not shown)	32#	E
59-V31-130	VALET PARKING CARD	96#	EE
59-LC1116	EVENT CARD	96#	AA

DESIGN ELEMENTS

Lettering	LET714
Ink	NAVY
Process	ENGRAVING
Paper	ECRU KID FINISH®

*Please join us for
Cocktails and Light Fare
on Saturday, October sixteenth
at six o'clock in the evening
842 Dunvegan Road
The Adamsons*

842 Dunvegan Road
 Toronto, Ontario
 M5P 2P2

ב"ה

Elena and Benjamin Adamson
 Eve and Joel Langer
 request the honour of your presence
 at the marriage of their children

Hailey Abigail

and

Benjamin Levi

Sunday, the seventeenth of October
 Chuppah at six-thirty in the evening
 The Royal Ontario Museum
 Toronto

PLEASE NOTE:

- Embassy folders may require additional postage.
- See Hebrew page for alternate Hebrew phrase motifs.

WARWICK SUITE • PRICE GROUP E

PAPER CODE	DESCRIPTION	WEIGHT
59-LF9116	EMBASSY INVITATION	64#
59-W65	INSIDE ENVELOPE (ungummed)	32#
59-W85	OUTSIDE ENVELOPE	32#
59-LE9116	SINGLE ENVELOPE (not shown)	32#

DESIGN ELEMENTS

Lettering	LET714
Motif	MOT1123A Bays Hay
Inks	NAVY
	BLIND EMBOSS
Processes	ENGRAVING
	BLIND EMBOSSING
Lining	LIN131A Navy (additional - price group HH)
Paper	ECRU KID FINISH®

MR. AND MRS. THOMAS JASPER CARLISLE

832 BEECHWOOD AVENUE

NASHVILLE, TENNESSEE 37212

The favour of a reply is requested

BY THE SEVENTH OF AUGUST

M _____

_____ ACCEPT WITH PLEASURE

_____ DECLINE WITH REGRET

NUMBER ATTENDING _____

BRITTANY SUITE

PAPER CODE	DESCRIPTION	WEIGHT	PRICE GROUP
59-LC1536	BEVELED PANEL RESPONSE/RECEPTION CARD	96#	I
59-LE1116	RESPONSE ENVELOPE	32#	I
59-LF1116	HEAVYWEIGHT NOTE	64#	W
59-LE1116	NOTE ENVELOPE	32#	W

DESIGN ELEMENTS

Lettering LET704W (swash), LET520 (block), LET704 (script)

Monogram MON303A

Ink POLISHED COPPER

Process ENGRAVING

Lining LIN792A Rose Gold (additional - price group HH)

Paper ECRU KID FINISH®



W-2022



PLEASE NOTE:
 • Royalty invitations will require additional postage.

BRITTANY SUITE • PRICE GROUP I

PAPER CODE	DESCRIPTION	WEIGHT
59-LC0536	ROYALTY BEVELED PANEL INVITATION	96#
59-W17	INSIDE ENVELOPE (ungummed)	32#
59-W37	OUTSIDE ENVELOPE	32#
59-LE0116	SINGLE ENVELOPE (not shown)	32#

DESIGN ELEMENTS

Lettering	LET520 (block), LET704W (swash)
Monogram	MON303B
Motif	MOT1482A Swash to
Ink	POLISHED COPPER
Process	ENGRAVING
Lining	LIN122D Ecu Moire (additional - price group HH)
Paper	ECRU KID FINISH®



CHARLOTTE SUITE

PAPER CODE	DESCRIPTION	WEIGHT	PRICE GROUP
59-C1116RGD	ROSE GOLD BORDERED		
	RESPONSE/RECEPTION CARD	96#	C
59-LE1116	RESPONSE ENVELOPE	32#	C
59-V31-130	INFORMATION CARD	96#	EE
59-LF1116	HEAVYWEIGHT NOTE	64#	W
59-LE1116	NOTE ENVELOPE	32#	W

DESIGN ELEMENTS

Lettering	LET706
Monogram	MON200D
Inks	PEWTER
	BLIND EMBOSS
Processes	ENGRAVING
	BLIND EMBOSSING
Lining	LIN1078B Gray Floral (additional - price group HH)
Paper	ECRU KID FINISH®



3201 West Lake Avenue
Baltimore, Maryland 21210

Mr. and Mrs. Darren Herbert Richardson
and
Ms. Shannon Kelley Parker
request the honour of your presence
at the marriage of their daughter

Elizabeth Parker Richardson

to

Phillip Cameron Wilson

son of

Mr. and Mrs. Timothy Ian Wilson

Saturday, the twentieth of November

Two thousand twenty-one

at four o'clock

The Chapel of the Church of the Redeemer

Baltimore, Maryland

PLEASE NOTE:

- Embassy invitations may require additional postage.

CHARLOTTE SUITE • PRICE GROUP C

PAPER CODE	DESCRIPTION	WEIGHT
59-C9116RGD	EMBASSY ROSE GOLD BORDERED INVITATION	96#
59-W65	INSIDE ENVELOPE (ungummed)	32#
59-W85	OUTSIDE ENVELOPE	32#
59-LE9116	SINGLE ENVELOPE (not shown)	32#

DESIGN ELEMENTS

Lettering	LET706
Ink	PEWTER
Process	ENGRAVING
Lining	LIN391B Pearl Stripe (additional - price group HH)
Paper	ECRU KID FINISH®

A M T



FIRST COURSE

FARM FRESH GREENS

TOASTED ALMONDS, CRANBERRIES, GOAT CHEESE
BALSAMIC VINAIGRETTE

ENTRÉE SELECTION

GRILLED BEEF TENDERLOIN

WITH NATIVE MAINE LOBSTER TAIL
ROASTED FINGERLING POTATOES, GRILLED ASPARAGUS

CORIANDER CRUSTED SEA BASS

WITH GRILLED VEGETABLE BASMATI RICE, BABY CARROTS

PHYLLO STAR

WITH ROASTED EGGPLANT AND OVEN DRIED TOMATO

DESSERT

MADAGASCAR VANILLA WEDDING CAKE

WITH RASPBERRY COULIS, CRÉME ANGLAISE AND FRESH BERRIES



Welcome Dinner

FRIDAY, 7:00 P.M.

THE SCHOONER AURORA

Brunch with us!

SUNDAY, 10:00 A.M. TO NOON

THE UPPER DECK

AT OCEANCLIFF



FOR ACCOMMODATIONS

AND ALL THE DETAILS

PLEASE VISIT

WWW.ADELLEANDTHEO.COM

W-2022

KINDLY REPLY

before

MAY TWENTY-NINTH

M _____

ACCEPTS
WITH PLEASURE

DECLINES
WITH REGRET

No. _____

No. _____

PLEASE NOTE:

- Marquis cards will require additional postage.
- Premium Weight papers are reserved for engraving and letterpress only.
- Premium Weight Gold Ink Edged orders will require 14 business days once order is received or final proof is approved, in addition to the printing process turn time.

REGENCY SUITE

PAPER CODE	DESCRIPTION	WEIGHT	PRICE GROUP
59-LCM116	MARQUIS CARD (shown as a Menu in two colors)	96#	H
59-LEM136	INSIDE ENVELOPE (ungummed, not shown)	32#	H
59-LEM146	OUTSIDE ENVELOPE (not shown)	32#	H
59-LEM136G	SINGLE ENVELOPE (not shown)	32#	W
59-LC1996	PREMIUM WEIGHT GOLD INK EDGED EVENT CARD	192#	O
59-LC1996	PREMIUM WEIGHT GOLD INK EDGED RESPONSE/RECEPTION CARD	192#	O
59-LE1116	RESPONSE ENVELOPE (not shown)	32#	O
DESIGN ELEMENTS			
Lettering	LET507 (shaded) LET551 (italic, shown all caps with letter spacing added) LET506S (block), LET728 (script)		
Monogram	MON505A		
Motifs	MOT1298A Flourish Top MOT1301B Flourish Bottom MOT033A Anchor MOT1510A Accepts/Declines with No.		
Inks	NAVY GOLD		
Process	ENGRAVING		
Paper	ECRU KID FINISH®		

MR. AND MRS. JAMES ALLEN RANDOLPH
 REQUEST THE PLEASURE OF YOUR COMPANY
 AT THE MARRIAGE OF THEIR DAUGHTER



ADELLE
KATHERINE
to
THEODORE
WESLEY MARTIN



SATURDAY, THE NINETEENTH OF JUNE
 TWO THOUSAND TWENTY-ONE
 AT FOUR O'CLOCK IN THE AFTERNOON

THE REGATTA PLACE
NEWPORT, RHODE ISLAND

Reception to follow



PLEASE NOTE:

- Royalty invitations will require additional postage.
- Premium Weight papers are reserved for engraving and letterpress only.
- Premium Weight Gold Ink Edged orders will require 14 business days once order is received or final proof is approved, in addition to the printing process turn time.

REGENCY SUITE • PRICE GROUP O

PAPER CODE	DESCRIPTION	WEIGHT
59-LCR0996	PREMIUM WEIGHT GOLD INK EDGED ROYALTY INVITATION	192#
59-W17	INSIDE ENVELOPE (ungummed, not shown)	32#
59-W37	OUTSIDE ENVELOPE (not shown)	32#
59-LE0116	SINGLE ENVELOPE	32#

DESIGN ELEMENTS

Lettering	LET507 (shaded), LET506S (block), LET511 (large block, shown all caps), LET728 (script) LET551 (italic, shown all caps with letter spacing added)
Motifs	MOT1298A Flourish Top MOT1301B Flourish Bottom MOT1509A Reception to Follow
Inks	NAVY, GOLD
Process	ENGRAVING
Lining	LIN292C Regency (additional - price group HH)
Paper	ECRU KID FINISH®



MR. AND MRS. KENNETH MATHIEWS
 INVITE YOU TO JOIN THEM FOR THE
 REHEARSAL DINNER

IN HONOR OF

KELSEA and ROBERT

FRIDAY, THE NINETEENTH OF FEBRUARY

TWO THOUSAND TWENTY-ONE

AT SIX O'CLOCK IN THE EVENING

TIDELINE RESORT

PALM BEACH, FLORIDA

RSVP 555-1212



RECEPTION

AT HALF AFTER FIVE O'CLOCK



CAFÉ BOULUD

THE BRAZILIAN COURT HOTEL

PALM BEACH

W-2022

ROCHESTER SUITE

PAPER CODE	DESCRIPTION	WEIGHT	PRICE GROUP
59-GB9116	EMBASSY GOLD BEVEL INVITATION	96#	B
59-LE9116	SINGLE ENVELOPE (not shown)	32#	B
59-GB1206	PREMIUM WEIGHT GOLD BEVEL RECEPTION CARD (shown 2 color)	192#	M
59-GB1116	GOLD BEVEL RESPONSE CARD	96#	B
59-LE1116	RESPONSE ENVELOPE (not shown)	32#	B

DESIGN ELEMENTS

Lettering	LET520 (block, shown all small caps with letter spacing added) LET507 (shaded) LET704 (script)
Monogram	MON532A
Motif	MOT570D Swirl
Inks	GOLD BLACK
Process	ENGRAVING
Paper	ECRU KID FINISH®

PLEASE NOTE:

- Embassy invitations may require additional postage.
- Premium Weight papers are reserved for engraving and letterpress only.

R.S.V.P.

BY THE THIRTIETH OF JANUARY





MR. AND MRS. RICHARD GAVIN STANLEY
REQUEST THE HONOUR OF YOUR PRESENCE
AT THE MARRIAGE OF THEIR DAUGHTER

KELSEA ANNE

to

MR. ROBERT ALAN MATHIEWS

SATURDAY, THE TWENTIETH OF FEBRUARY
TWO THOUSAND TWENTY-ONE
AT THREE O'CLOCK



BETHESDA-BY-THE-SEA EPISCOPAL CHURCH
PALM BEACH, FLORIDA

10873 EGRET POINTE LANE
WEST PALM BEACH, FLORIDA 33412

PLEASE NOTE:

- Royalty invitations are not available with die cuts or bleed motifs and will require additional postage.
- Premium Weight papers are reserved for engraving and letterpress only.

ROCHESTER SUITE • PRICE GROUP M

PAPER CODE	DESCRIPTION	WEIGHT
59-LCR0206	ROYALTY PREMIUM WEIGHT GOLD BEVEL INVITATION (shown 2 color)	192#
59-W17	INSIDE ENVELOPE (ungummed)	32#
59-W37	OUTSIDE ENVELOPE	32#
59-LE0116	SINGLE ENVELOPE (not shown)	32#

DESIGN ELEMENTS

Lettering	LET520 (block, shown all small caps with letter spacing added) LET507 (shaded)
Monogram	MON532A
Motifs	MOT1482A Swash to MOT570D Swirl
Inks	GOLD BLACK
Process	ENGRAVING
Lining	LIN099D Linen Gold (additional - price group HH)
Paper	ECRU KID FINISH®

*The favour of your reply
is requested by the second of October*

*M _____
will _____ attend*

Doctor and Mrs. James Michael Randolph

341 Clay Street

Franklin, Virginia 23851

LOIRE SUITE • PRICE GROUP C

PAPER CODE	DESCRIPTION	WEIGHT
59-C1116GLD	GOLD BORDERED RESPONSE CARD	96#
59-LE1116	RESPONSE ENVELOPE	32#
59-C1116GLD	GOLD BORDERED RECEPTION CARD	96#

DESIGN ELEMENTS

Lettering	T390
Ink	NAVY
Process	THERMOGRAPHY
Paper	ECRU KID FINISH®

Reception to follow

The Commonwealth Club

401 West Franklin Street

341 Clay Street
Franklin, Virginia 23851

Dr. and Mrs. James Michael Randolph
request the honour of your presence
at the marriage of their daughter

Michelle Emily

to

Jackson Charles Stanford

Saturday, the twenty-first of October

Two thousand twenty-three

at five o'clock

Reveille United Methodist Church

Richmond, Virginia

W-2022

PLEASE NOTE:

- Embassy invitations may require additional postage.

LOIRE SUITE • PRICE GROUP C

PAPER CODE	DESCRIPTION	WEIGHT
59-C9116GLD	EMBASSY GOLD BORDERED INVITATION	96#
59-W65	INSIDE ENVELOPE (ungummed)	32#
59-W85	OUTSIDE ENVELOPE	32#
59-LE9116	SINGLE ENVELOPE (not shown)	32#

DESIGN ELEMENTS

Lettering	T390
Ink	NAVY
Process	THERMOGRAPHY
Lining	LIN445E Vintage Gold Floral (additional - price group HH)
Paper	ECRU KID FINISH®

Welcome Party

PLEASE JOIN US TO KICK OFF
THE WEDDING CELEBRATIONS

FRIDAY, SEPTEMBER 8, 2023
FROM 7:00 PM - 11:00 PM

Chatham Beach and Tennis Club
12 MAIN STREET
CHATHAM, MASSACHUSETTS

hosted by
LYNDA AND ALLEN MCDONOUGH

COCKTAILS, HORS D'OEUVRES
AND DESSERT WILL BE SERVED



RSVP AT LYNDAMCDONOUGH.COM

Details
FOR TRAVEL INFORMATION
AND ACCOMMODATIONS



PLEASE VISIT
GEORGIAANDERIC.COM

PALOMA SUITE

PAPER CODE	DESCRIPTION	WEIGHT	PRICE GROUP
59-LC3322	BEACH GLASS EVENT CARD	96#	R
59-LE3111	ENVELOPE	32#	R
59-LE3322	BEACH GLASS ENVELOPE (not shown)	32#	R
59-V19-130	BEACH GLASS DETAILS CARD	96#	EE
59-LC1322	BEACH GLASS RESPONSE/RECEPTION CARD	96#	H
59-LE1111	PEARL WHITE RESPONSE ENVELOPE (not shown)	32#	H
59-LE1322	BEACH GLASS RESPONSE ENVELOPE (not shown)	32#	H

DESIGN ELEMENTS

Lettering	LET712 (script) LET520 (block, shown all small caps with letter spacing added)
Motifs	MOT462A Seashell MOT457A Sand Dollar MOT1046A Two Pencil Starfish
Ink	GOLD
Process	ENGRAVING
Lining	LIN284B Gold Micro Stripe (additional - price group HH)
Paper	BEACH GLASS KID FINISH® PEARL WHITE KID FINISH® (envelope)

Kindly reply
BEFORE THE TWENTY-FIRST OF AUGUST

M _____

_____ HAPPILY ACCEPTS

_____ SADLY, MUST DECLINE





MR. AND MRS. GREGORY NELSON DOUGLAS
 INVITE YOU TO JOIN IN CELEBRATING
 THE MARRIAGE OF THEIR DAUGHTER

Georgia Courtney

TO

Eric Liam McDonough

SON OF MR. AND MRS. ALLEN MATTHEW MCDONOUGH

SATURDAY, THE NINTH OF SEPTEMBER
 TWO THOUSAND TWENTY-THREE
 AT THREE O'CLOCK IN THE AFTERNOON
 WYCHMERE BEACH CLUB
 23 SNOW INN ROAD
 HARWICH FORT, MASSACHUSETTS

Cocktails, dinner and dancing to follow

Mr. and Mrs. Gregory N. Douglas
 48 KNOLLWOOD ROAD
 MEDFIELD, MASSACHUSETTS 02052

PLEASE NOTE:

- Royalty invitations will require additional postage.
- Premium Weight papers are reserved for engraving and letterpress only.
- Double Envelopes are not available for colored papers.

PALOMA SUITE • PRICE GROUP L

PAPER CODE	DESCRIPTION	WEIGHT
59-LCR0322	ROYALTY PREMIUM WEIGHT BEACH GLASS INVITATION (shown 2 color)	192#
59-W13	INSIDE ENVELOPE (ungummed)	32#
59-W33	OUTSIDE ENVELOPE	32#
59-LE0111	SINGLE ENVELOPE (not shown)	32#
59-LE0322	BEACH GLASS SINGLE ENVELOPE (not shown)	32#

DESIGN ELEMENTS

Lettering	LET520 (block, shown all small caps with letter spacing added) LET712 (script)
Monogram	MON439A
Inks	GOLD
Process	ENGRAVING
Lining	LIN178B Gold Lustre (additional - price group HH)
Paper	BEACH GLASS KID FINISH® PEARL WHITE KID FINISH®

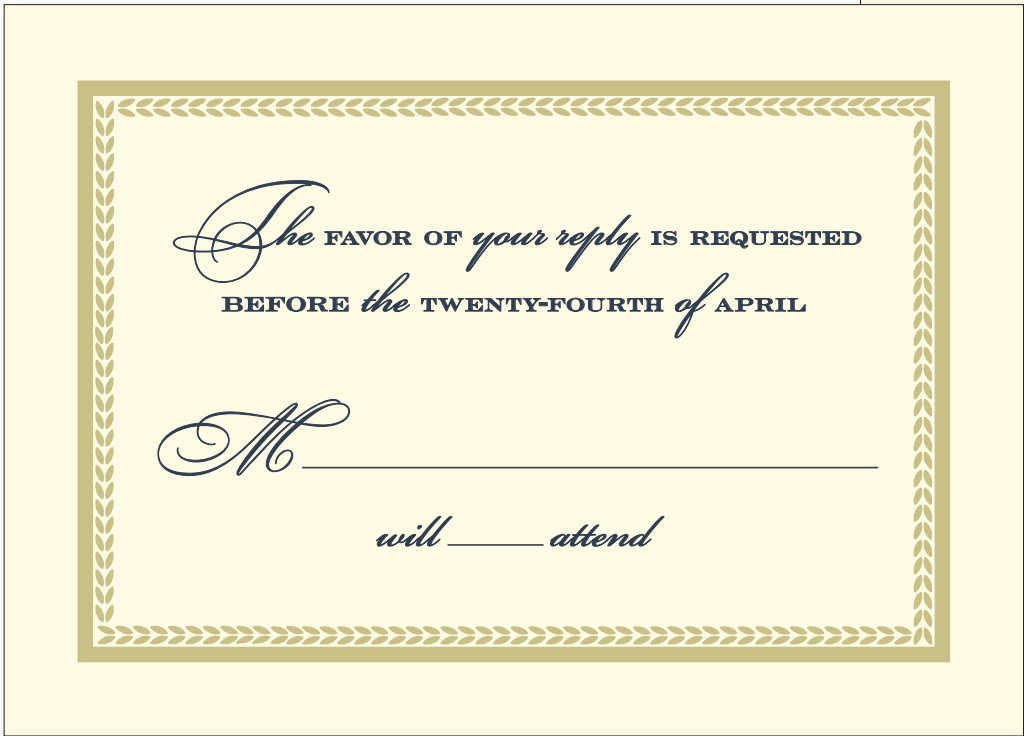
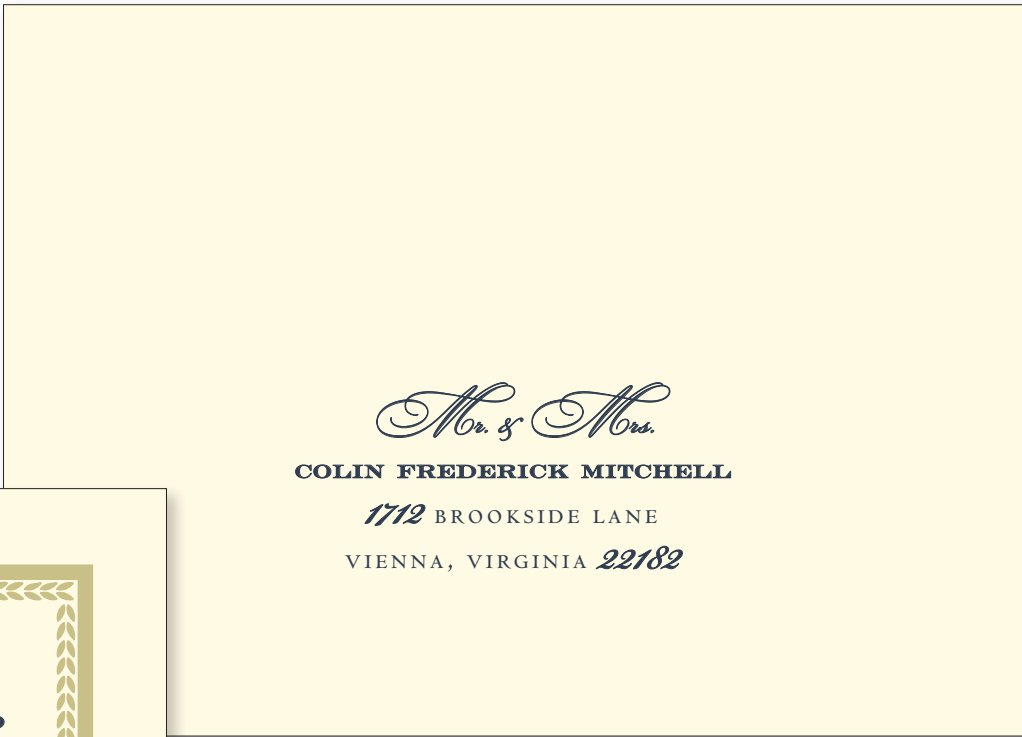

ACADIA SUITE • PRICE GROUP I

PAPER CODE	DESCRIPTION	WEIGHT
59-LC1106	TRAILING LEAVES RESPONSE CARD	96#
59-LE1116	RESPONSE ENVELOPE	32#
59-LC1106	TRAILING LEAVES RECEPTION CARD	96#

DESIGN ELEMENTS

Lettering	LET704W (swash)
	LET512 (bold block)
	LET506S (block)
Motif	MOT1489A Leaf Duet
Ink	CHARCOAL
Process	ENGRAVING
Paper	ECRU KID FINISH®

1712 BROOKSIDE LANE
VIENNA, VIRGINIA 22182



MR. AND MRS. COLIN FREDERICK MITCHELL

REQUEST THE PLEASURE OF YOUR COMPANY

AT THE MARRIAGE OF THEIR DAUGHTER

Abigail Jordan

TO

Blake Richard Thompson

SATURDAY, THE THIRTEENTH OF MAY

TWO THOUSAND TWENTY-THREE

AT FIVE O'CLOCK

VIENNA PRESBYTERIAN CHURCH

VIENNA, VIRGINIA

PLEASE NOTE:

- Marquis Trailing Leaves invitations will require additional postage.

W-2022

ACADIA SUITE • PRICE GROUP I

PAPER CODE	DESCRIPTION	WEIGHT
59-LCM106	MARQUIS TRAILING LEAVES INVITATION	96#
59-LEM136	INSIDE ENVELOPE (ungummed)	32#
59-LEM146	OUTSIDE ENVELOPE	32#
59-LEM136G	SINGLE ENVELOPE (not shown)	32#

DESIGN ELEMENTS

Lettering	LET512 (bold block), LET506S (block), LET704W (swash)
Monogram	MON532A
Inks	PLATINUM CHARCOAL
Process	ENGRAVING
Lining	LIN177B Silver Lustre (additional - price group HH)
Paper	ECRU KID FINISH®



W-2022



VIENNA SUITE

PAPER CODE	DESCRIPTION	WEIGHT	PRICE GROUP
59-GB1116	GOLD BEVEL RESPONSE/RECEPTION CARD	96#	J
59-LE1116	RESPONSE ENVELOPE (not shown)	32#	J
59-F1116GLD	GOLD BORDERED HEAVYWEIGHT NOTE	64#	X
59-LE1116	NOTE ENVELOPE	32#	X

DESIGN ELEMENTS

Lettering	LET705 (script), LET625 (block)
Motifs	MOT1515A Small Diamond MOT269B Ornament
Inks	KONA GOLD
Process	ENGRAVING
Lining	LIN443E Metallic Gold (additional - price group HH)
Paper	ECRU KID FINISH®



Kim Thao Duong
and
Jeremy Harold Kaufman

TOGETHER WITH THEIR FAMILIES
 REQUEST THE PLEASURE OF YOUR COMPANY
 AT THE CELEBRATION OF THEIR MARRIAGE

SATURDAY, THE SECOND OF OCTOBER
 TWO THOUSAND TWENTY-ONE
 AT FIVE O'CLOCK IN THE AFTERNOON

SOWDEN HOUSE
 HOLLYWOOD, CALIFORNIA

Black Tie

5700 SEAWALK DRIVE, APARTMENT FIVE
 PLAYA VISTA, CALIFORNIA 90094

PLEASE NOTE:
 • Royalty invitations will require additional postage.

VIENNA SUITE • PRICE GROUP J

PAPER CODE	DESCRIPTION	WEIGHT
59-LC0116	ROYALTY GOLD BEVEL INVITATION (shown 2 color)	96#
59-W17	INSIDE ENVELOPE (ungummed)	32#
59-W37	OUTSIDE ENVELOPE	32#
59-LE0116	SINGLE ENVELOPE (not shown)	32#

DESIGN ELEMENTS

Lettering	LET705 (script), LET625 (block)
Motif	MOT269B Ornament
Inks	GOLD KONA
Process	ENGRAVING
Lining	LIN382S Golden Swirl (additional - price group HH)
Paper	ECRU KID FINISH®

*Mr. and Mrs. Ethan Stephen Morneau
request the honour of your presence
at the marriage of their daughter*

Elena Shannon

to

Doctor Sean Joseph Morley, III

Saturday, the thirteenth of March

two thousand twenty-one

at six o'clock in the evening

First Presbyterian Church

100 School Street

Greer, South Carolina

At Home

after the twenty-seventh of March

3284 Cottonwood Drive

Aiken, South Carolina 29803

WINCHESTER SUITE

PAPER CODE	DESCRIPTION	WEIGHT	PRICE GROUP
59-LF9116	EMBASSY INVITATION	64#	E
59-V31-130	AT HOME CARD	96#	EE
59-LC1116	RECEPTION/RESPONSE CARD	96#	E
59-LE1116	RESPONSE ENVELOPE (not shown)	32#	E

DESIGN ELEMENTS

Lettering	T169
Ink	BLACK
Processes	THERMOGRAPHY, FLAT (invite inside)
Paper	ECRU KID FINISH®

Reception to follow

Poinsett Club

807 East Washington Street

Greenville, South Carolina

The favour of a reply is requested

204 Antigua Way

Greer, South Carolina 29650

*204 Antigua Way
Greer, South Carolina 29650*

EMS

PLEASE NOTE:

- Embassy folders may require additional postage.

W-2022

WINCHESTER SUITE • PRICE GROUP E

PAPER CODE	DESCRIPTION	WEIGHT
59-LF9116	EMBASSY INVITATION	64#
59-W65	INSIDE ENVELOPE (ungummed)	32#
59-W85	OUTSIDE ENVELOPE	32#
59-LE9116	SINGLE ENVELOPE (not shown)	32#

DESIGN ELEMENTS

Lettering	T169
Monogram	MON200D
Inks	GOLD BLACK
Process	THERMOGRAPHY
Lining	LIN099D Linen Gold (additional - price group HH)
Paper	ECRU KID FINISH®

Accommodations

A block of rooms has been reserved at the following hotels.
Please refer to the Flynn/Wainwright wedding when making
reservations to receive the special rate.

THE ST. REGIS
www.stregisnewyork.com 888-627-7103

THE RITZ-CARLTON
www.ritzcarlton.com/New-York 800-542-8680

Please make your reservations prior to September 4th.

Visit us at
flynnwainwrightwed.com for additional details

Kindly respond

BY THE EIGHTEENTH OF SEPTEMBER

SIENA SUITE

PAPER CODE	DESCRIPTION	WEIGHT	PRICE GROUP
59-LC3116	ACCOMMODATIONS CARD	96#	R
59-LC1116	RESPONSE/RECEPTION CARD	96#	H
59-LE1116	RESPONSE ENVELOPE (not shown)	32#	H
59-LF1116	HEAVYWEIGHT NOTE	64#	W
59-LE1116	NOTE ENVELOPE	32#	W

DESIGN ELEMENTS

Lettering	LET516 (block), LET728 (script)
Motif	MOT1311A Branch
Inks	CHARCOAL GOLD
Process	ENGRAVING
Lining	LIN490E Grey and Gold Marble (additional - price group HH)
Paper	ECRU KID FINISH®

Elizabeth Wainwright



MR. AND MRS. CHARLES KENNETH FLYNN
34 Beechwood Boulevard
Rye Brook, New York 10573

MR. AND MRS. CHARLES KENNETH FLYNN
request the pleasure of your company at the marriage of their daughter

Elizabeth Sarah
to
Matthew Darren Wainwright

SATURDAY, THE SEVENTH OF OCTOBER

Two thousand twenty-three
at six o'clock in the evening

THE ST. REGIS
New York, New York

Reception to follow

PLEASE NOTE:
• Royalty invitations will
require additional postage.

SIENA SUITE • PRICE GROUP H

PAPER CODE	DESCRIPTION	WEIGHT
59-LC0106	ROYALTY INVITATION (shown 2 color)	96#
59-W17	INSIDE ENVELOPE (ungummed)	32#
59-W37	OUTSIDE ENVELOPE	32#
59-LE0116	SINGLE ENVELOPE (not shown)	32#

DESIGN ELEMENTS

Lettering	LET516 (block) LET728 (script)
Motif	MOT1509A Reception to Follow
Inks	CHARCOAL, GOLD
Process	ENGRAVING
Lining	LIN469C Damask Cream (additional - price group HH)
Paper	ECRU KID FINISH®

The favour of a reply is requested

BY THE TWENTY-FIRST OF AUGUST

M _____

WILL _____ ATTEND

Cocktails, dinner and dancing

FOLLOWING THE CEREMONY

at

THREE O'CLOCK IN THE EVENING

Woodbury Country Club

540 HOYS STREET

DARIEN, CONNECTICUT



WHITNEY SUITE

PAPER CODE	DESCRIPTION	WEIGHT	PRICE GROUP
59-LC1111	RESPONSE CARD	96#	H
59-LE1111	RESPONSE ENVELOPE (not shown)	32#	L
59-LC1661	PREMIUM WEIGHT RECEPTION CARD	192#	L
59-F1111GLD	GOLD BORDERED HEAVYWEIGHT NOTE	64#	W
59-LE1111	NOTE ENVELOPE	32#	W

DESIGN ELEMENTS

Lettering	LET704 (script) LET609S (block)
Monogram	MON307A
Ink Edge	PEWTER (on response and reception cards)
Ink	PEWTER
Process	ENGRAVING
Lining	LIN177B Silver Lustre (additional - price group HH)
Paper	PEARL WHITE KID FINISH®

PLEASE NOTE:

- For painted edge treatments shown, orders need to indicate color choice and will require additional delivery time.



Mr. and Mrs. Thomas Joseph Anderson

REQUEST THE HONOUR OF YOUR PRESENCE
AT THE MARRIAGE OF THEIR DAUGHTER

Stephanie Roberta

to

Mr. Richard Wylie Albert, junior

SATURDAY, THE SIXTEENTH OF SEPTEMBER
TWO THOUSAND TWENTY-THREE

at

ONE O'CLOCK IN THE AFTERNOON

Saint Aloysius Church

NEW CANAAN, CONNECTICUT

*Tom Blueberry Lane
South Salem, New York 10590*

PLEASE NOTE:

- Royalty invitations will require additional postage.
- For the painted edge treatment shown, orders need to indicate color choice and will require additional delivery time.

WHITNEY SUITE • PRICE GROUP L

PAPER CODE	DESCRIPTION	WEIGHT
59-LCR0161	ROYALTY PREMIUM WEIGHT INVITATION (shown 2 color)	192#
59-W13	INSIDE ENVELOPE (ungummed)	32#
59-W33	OUTSIDE ENVELOPE	32#
59-LE0111	SINGLE ENVELOPE (not shown)	32#

DESIGN ELEMENTS

Lettering	LET704 (script), LET609S (block)
Monogram	MON307B
Ink Edge	PEWTER
Inks	PEWTER, GOLD
Process	ENGRAVING
Lining	LIN123D White Moire Fabric (additional - price group HH)
Paper	PEARL WHITE KID FINISH®



W-2022

A SPECIAL ROOM RATE HAS BEEN RESERVED
 FOR THE LANGEVIN / PALACIO WEDDING CELEBRATION
 PLEASE CALL (877) 590-5187 PRIOR TO 11/06/23

PLEASE JOIN US FRIDAY NIGHT FOR COCKTAILS AND DINNER
 THE DUSK RESTAURANT AT SEVEN O'CLOCK



KINDLY R.S.V.P. BEFORE NOVEMBER TWENTIETH
 VIA CRYSTALANDANTONIOWED.COM

LAGUNA SUITE • PRICE GROUP A

PAPER CODE	DESCRIPTION	WEIGHT
59-LC9322	EMBASSY INVITATION	96#
59-LE9322	SINGLE ENVELOPE	32#
59-LC1322	RESPONSE/RECEPTION CARD	96#
59-LE1322	RESPONSE ENVELOPE (not shown)	32#

DESIGN ELEMENTS

Lettering	LET706 (script), LET522 (shaded block), LET520 (block)
Motifs	MOT178B Palm Tree MOT455A Sea Grass
Ink	TAUPE
Process	LETTERPRESS
Lining	LIN278B Champagne Shimmer (additional - price group HH)
Paper	BEACH GLASS KID FINISH®

PLEASE NOTE:

- Embassy invitations may require additional postage.
- Double Envelopes are not available for colored papers.

PLEASE NOTE:

- Royalty invitations will require additional postage.

MR. AND MRS. EDWARD RAYMOND HENDERSON
REQUEST THE PLEASURE OF YOUR COMPANY
AT THE MARRIAGE OF THEIR DAUGHTER

Rachel Annabelle

TO

Nathaniel Drew Bentley

SATURDAY, THE TWENTY-EIGHTH OF OCTOBER
TWO THOUSAND TWENTY-THREE
AT HALF AFTER SIX O'CLOCK IN THE EVENING

Rosewood Mayakoba

RIVIERA MAYA | QUINTANA ROO

MEXICO



Reception to follow

BIANCA SUITE • PRICE GROUP H

PAPER CODE	DESCRIPTION	WEIGHT
59-LC0101	ROYALTY INVITATION	96#
59-W13	INSIDE ENVELOPE (ungummed, not shown)	32#
59-W33	OUTSIDE ENVELOPE (not shown)	32#
59-LE0111	SINGLE ENVELOPE	32#
59-LC1111	RESPONSE/RECEPTION CARD	96#
59-LE1111	RESPONSE ENVELOPE (not shown)	32#

DESIGN ELEMENTS

Lettering	LET516 (block), LET712 (script)
Motif	MOT780A Printer's Ornament
Frame	FRA030
Ink	POLISHED COPPER
Process	ENGRAVING
Lining	LIN277B Pearl Shimmer (additional - price group HH)
Paper	PEARL WHITE KID FINISH®

Kindly reply by
THE NINTH OF OCTOBER

M _____

_____ JOYFULLY ACCEPT

_____ REGRETFULLY DECLINE



PLEASE NOTE:
 • Embassy invitations may require additional postage.

CARLISLE SUITE • PRICE GROUP D

PAPER CODE	DESCRIPTION	WEIGHT
59-LC9986	BEADED FRAME INVITATION	96#
59-W65	INSIDE ENVELOPE (ungummed, not shown)	32#
59-W85	OUTSIDE ENVELOPE (not shown)	32#
59-LE9116	SINGLE ENVELOPE	32#
59-LC1986	BEADED FRAME RESPONSE/RECEPTION CARD	96#
59-LE1116	RESPONSE ENVELOPE (not shown)	32#

DESIGN ELEMENTS

Lettering	LET619 (block), LET712 (script)
Motifs	MOT1004A Line Knot
Ink	PEACOCK
Process	ENGRAVING
Lining	LIN278B Champagne Shimmer (additional - price group HH)
Paper	ECRU KID FINISH®



PLEASE NOTE:

- Royalty invitations will require additional postage.
- Premium Weight Lettra papers are reserved for engraving and letterpress only.

*Mr. and Mrs. Leonard Charles Ashton
request the pleasure of your company
at the marriage of their daughter*

Emma Jayne

to

Daniel Stephen Rochester

Saturday, the twenty-fourth of April

Two thousand twenty-one

at four o'clock in the afternoon

The Brass on Baltimore

Kansas City, Missouri

Reception to follow

*4940 Summit Street
Kansas City, Missouri 64112*

W-2022

*The favour of a reply is requested
before the third of April*

M _____

will _____ attend

KESWICK SUITE • PRICE GROUP L

PAPER CODE	DESCRIPTION	WEIGHT
59-LCR0261	ROYALTY PREMIUM WEIGHT INVITATION	220#
59-W54	INSIDE ENVELOPE (ungummed)	32#
59-W55	OUTER ENVELOPE	32#
59-LE0721	SINGLE ENVELOPE (not shown)	32#
59-LC1901	PREMIUM WEIGHT RESPONSE/RECEPTION CARD	220#
59-LE1721	RESPONSE ENVELOPE (not shown)	32#

DESIGN ELEMENTS

Lettering	LET728
Motifs	MOT1521A Reception to follow MOT1516A The favour of a reply is requested
Ink	GOLD
Process	ENGRAVING
Lining	LIN284B Gold Micro Stripe (additional - price group HH)
Paper	PEARL WHITE LETTRA®

CJS

Mr. and Mrs. Nathan Charles Wright
request the pleasure of your company
at the marriage of their daughter

CARLY NICOLE

to

SAMUEL PHILLIP JONES

Saturday, the twenty-fourth of July
two thousand twenty-one
at one o'clock in the afternoon

THE POLO BARN AT SAXONY FARM
Lexington, Kentucky

Dinner and dancing to follow

PLEASE NOTE:

- Embassy invitations may require additional postage.

CJS

Accommodations
Hilton/Lexington Downtown
369 West Vine Street
859-231-9000

A block of rooms
has been reserved under
the Wright/Jones Wedding

R.S.V.P.

before the third of July via our website:

WWW.CARLYANDSAM.COM

OXFORD SUITE • PRICE GROUP A

PAPER CODE	DESCRIPTION	WEIGHT
59-LC9826	EMBASSY INVITATION (shown 2 color)	110#
59-W95	INSIDE ENVELOPE (ungummed, not shown)	32#
59-W96	OUTSIDE ENVELOPE (not shown)	32#
59-LE9326	SINGLE ENVELOPE	32#
59-LC1026	ACCOMMODATION CARD	110#
59-LC1026	RESPONSE/RECEPTION CARD (not shown)	110#
59-LE1326	RESPONSE ENVELOPE (not shown)	32#

DESIGN ELEMENTS

Lettering	LET619 (block), LET513 (small cap block), LET517 (italic)
Monogram	MON414A
Frame	FRA012
Inks	RASPBERRY, PEWTER
Process	LETTERPRESS
Lining	LIN058A Raspberry (additional - price group HH)
Paper	ECRU LETTRA®

PLEASE NOTE:

- Royalty invitations will require additional postage.
- Premium Weight Lettra papers are reserved for engraving and letterpress only.

LRM

Together with their families

the pleasure of your company is requested at the marriage of

Lindsay Hopkins and Morgan Raab

Saturday, the twenty-fifth of September
two thousand twenty-one
at five o'clock in the afternoon

The Rainier Club
820 4th Avenue
Seattle, Washington



Reception immediately following

W-2022

RSVP

before the fourth of September

M _____

_____ will attend _____ will not attend

VERONA SUITE • PRICE GROUP L

PAPER CODE	DESCRIPTION	WEIGHT
59-LCR0266	ROYALTY PREMIUM WEIGHT INVITATION (shown 2 color)	220#
59-W57	INSIDE ENVELOPE (ungummed, not shown)	32#
59-W59	OUTSIDE ENVELOPE (not shown)	32#
59-LE0726	SINGLE ENVELOPE	32#
59-LC1906	PREMIUM WEIGHT RESPONSE/RECEPTION CARD (shown 2 color)	220#
59-LE1326	RESPONSE ENVELOPE (not shown)	32#

DESIGN ELEMENTS

Lettering	LET516 (block), LET709 (script)
Monogram	M451
Motifs	MOT1317A Flourish, MOT1327A RSVP
Ink	TAUPE, BLIND DEBOSS (reserved for letterpress only)
Process	LETTERPRESS
Lining	LIN469C Damask Cream (additional - price group HH)
Paper	ECRU LETTRA®

PLEASE NOTE:

- Embassy invitations may require additional postage.



TOGETHER WITH THEIR FAMILIES

RILEY DEVIN NICHOLS

and

BENJAMIN JACOB SIMMONS

REQUEST THE PLEASURE OF YOUR COMPANY

AT THE CELEBRATION OF THEIR MARRIAGE

SATURDAY, THE TWENTY-SIXTH OF AUGUST

AT SIX O'CLOCK IN THE EVENING

RITTENHOUSE HOTEL

PHILADELPHIA

Dinner and dancing to follow

W-2022

REVERE SUITE • PRICE GROUP C

PAPER CODE	DESCRIPTION	WEIGHT
59-C9111PLT	EMBASSY PLATINUM BORDERED INVITATION	96#
59-W60	INSIDE ENVELOPE (ungummed, not shown)	32#
59-W80	OUTSIDE ENVELOPE (not shown)	32#
59-LE9111	SINGLE ENVELOPE	32#
59-C1111PLT	PLATINUM BORDERED RESPONSE/RECEPTION CARD	96#
59-LE1111	RESPONSE ENVELOPE (not shown)	32#

DESIGN ELEMENTS

Lettering	LET506S (block), LET716 (script)
Monogram	MON557C
Motifs	MOT1512A Small Line MOT1513A RSVP with Small Line
Ink	CHARCOAL
Process	THERMOGRAPHY
Lining	LIN177B Silver Lustre (additional - price group HH)
Paper	PEARL WHITE KID FINISH®

R S V P

before the thirty-first of July

PLEASE NOTE:

- Royalty Pearl Frame invitations will require additional postage.
- See Hebrew page for alternate Hebrew phrase motifs.

ב"ה

*Mr. and Mrs. Thomas Aaron Smith
Mr. and Mrs. Robert Jason Kassin
request the honour of your presence
at the marriage uniting their children*

*Amanda
and
Joshua*

*Sunday, the fourteenth of January
two thousand twenty-three
at five o'clock in the afternoon
Sixth and Historic Synagogue
600 I Street, N.W.
Washington, District of Columbia*

2198 NORTH VEITCH STREET #110
ARLINGTON, VIRGINIA 22201

W-2022

*Please join us in celebration
immediately following the ceremony
Sequoia at Washington Harbour
3000 I Street N.W.
Washington, District of Columbia*

LANCASTER SUITE • PRICE GROUP I

PAPER CODE	DESCRIPTION	WEIGHT
59-LC0141	ROYALTY PEARL FRAME INVITATION	96#
59-W13	INSIDE ENVELOPE (ungummed)	32#
59-W33	OUTER ENVELOPE	32#
59-LE0111	SINGLE ENVELOPE (not shown)	32#
59-LC1141	PEARL FRAME RESPONSE/RECEPTION CARD	96#
59-LE1111	RESPONSE ENVELOPE (not shown)	32#

DESIGN ELEMENTS

Lettering	LET705 (script), LET625 (block on envelope)
Motif	MOT1123A Bays Hay
Inks	NAVY, BLIND EMBOSS
Processes	ENGRAVING, BLIND EMBOSSING
Lining	LIN131A Navy (additional - price group HH)
Paper	PEARL WHITE KID FINISH®



W-2022

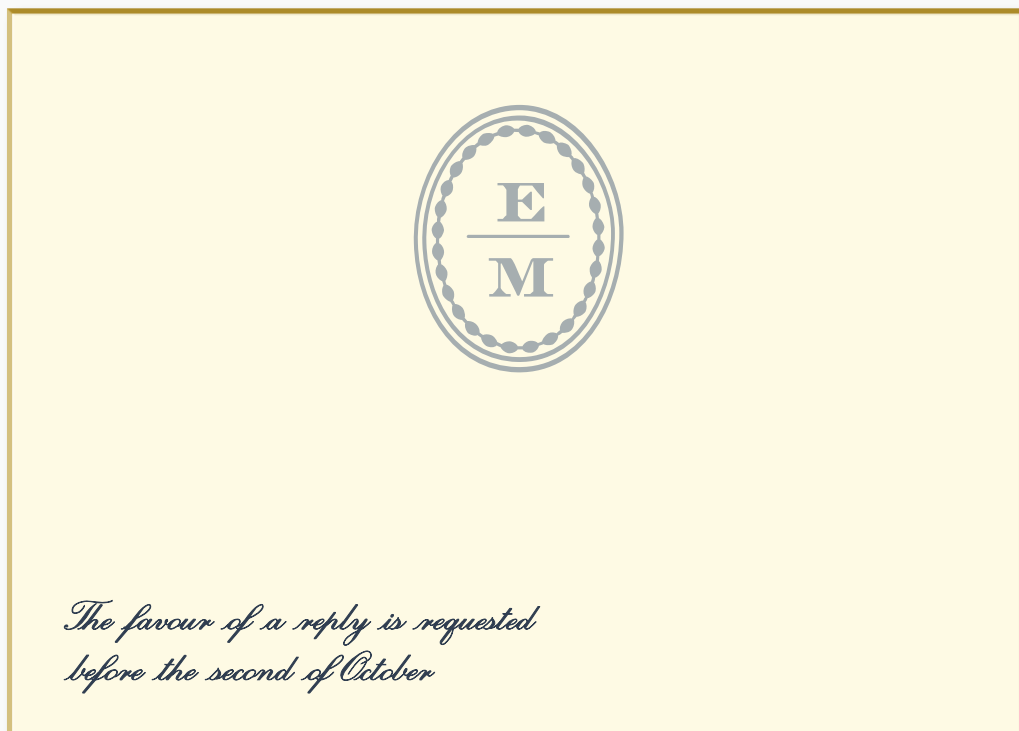

CHELSEA SUITE • PRICE GROUP B

PAPER CODE	DESCRIPTION	WEIGHT
59-GB9116	EMBASSY GOLD BEVEL INVITATION (shown 2 color)	96#
59-W65	INSIDE ENVELOPE (ungummed, not shown)	32#
59-W85	OUTSIDE ENVELOPE (not shown)	32#
59-LE9116	SINGLE ENVELOPE	32#
59-GB1116	GOLD BEVEL RESPONSE/RECEPTION CARD (shown 2 color)	96#
59-LE1116	RESPONSE ENVELOPE (not shown)	32#

DESIGN ELEMENTS

Lettering	LET513 (block) LET716 (script)
Monogram	MON512A
Inks	CHARCOAL, BLIND EMBOSS
Processes	THERMOGRAPHY, BLIND EMBOSSING
Lining	LIN278B Champagne Shimmer (additional - price group HH)
Paper	ECRU KID FINISH®

PLEASE NOTE:

- Embassy invitations may require additional postage.

PLEASE NOTE:

- Embassy invitations may require additional postage.

**MR. AND MRS. PARKER JAMES TURNER
REQUEST THE PLEASURE OF YOUR COMPANY
AT THE MARRIAGE OF THEIR DAUGHTER**

Julia Alyssa
TO
Colin Robert Lachman

**SATURDAY, THE TWENTY-FIRST OF JANUARY
TWO THOUSAND TWENTY-THREE
AT HALF AFTER SIX O'CLOCK IN THE EVENING**

The Manor House

**7440 SOUTH MASON MONTGOMERY ROAD
MASON, OHIO**

Cocktails, Dinner and Dancing
IMMEDIATELY FOLLOWING THE CEREMONY

R.s.v.p.

BY JANUARY 2, 2023

M _____

_____ **WOULDN'T MISS IT FOR THE WORLD**

_____ **NUMBER ATTENDING**

_____ **WILL BE THERE IN SPIRIT**

JULIA SUITE • PRICE GROUP A

PAPER CODE	DESCRIPTION	WEIGHT
59-LC9116	EMBASSY INVITATION	96#
59-W65	INSIDE ENVELOPE (ungummed, not shown)	32#
59-W85	OUTSIDE ENVELOPE (not shown)	32#
59-LE9116	SINGLE ENVELOPE	32#
59-LC1116	RESPONSE/RECEPTION CARD	96#
59-LE1116	RESPONSE ENVELOPE (not shown)	32#

DESIGN ELEMENTS

Lettering	LET512 (block) LET705 (script)
Ink	BLACK
Process	THERMOGRAPHY
Lining	LIN468C Gold Damask on Black (additional - price group HH)
Paper	ECRU KID FINISH®



PLEASE NOTE:

- Embassy invitations may require additional postage.
- Letra papers are reserved for engraving or letterpress only.

HAYWORTH SUITE • PRICE GROUP D

PAPER CODE	DESCRIPTION	WEIGHT
59-LC9781	EMBASSY ELEGANT FRAME INVITATION	110#
59-W90	INSIDE ENVELOPE (ungummed, not shown)	32#
59-W91	OUTSIDE ENVELOPE (not shown)	32#
59-LE9821	SINGLE ENVELOPE	32#
59-LC1781	ELEGANT FRAME RESPONSE/RECEPTION CARD	110#
59-LE1721	RESPONSE ENVELOPE (not shown)	32#

DESIGN ELEMENTS

Lettering	LET506S (block) LET728 (script)
Motif	MOT1409A Small Calligraphic Swash
Ink	CHARCOAL
Process	LETTERPRESS
Lining	LIN178B Gold Lustre (additional - price group HH)
Paper	PEARL WHITE LETTRA®



TOGETHER WITH THEIR FAMILIES

*Dakota Skylar
Anderson
and
Logan Parker
Mooreland*

REQUEST THE PLEASURE OF YOUR COMPANY
AT THE CELEBRATION OF THEIR MARRIAGE
SATURDAY, THE ELEVENTH OF MARCH
TWO THOUSAND TWENTY-THREE
AT FIVE O'CLOCK



TOSCANA COUNTRY CLUB
INDIAN WELLS, CALIFORNIA

Reception immediately following the ceremony

PLEASE NOTE:
• Marquis cards will require
additional postage.

PRESTON SUITE • PRICE GROUP H

PAPER CODE	DESCRIPTION	WEIGHT
59-LCM111	MARQUIS INVITATION (shown 2 color)	96#
59-LEM131	INSIDE ENVELOPE (ungummed, not shown)	32#
59-LEM141	OUTSIDE ENVELOPE (not shown)	32#
59-LEM131G	SINGLE ENVELOPE	32#
59-LC1111	RESPONSE/RECEPTION CARD	96#
59-LE1111	RESPONSE ENVELOPE (not shown)	32#

DESIGN ELEMENTS

Lettering	LET520 (block, shown in small caps with letter spacing added) LET704 (script)
Motifs	MOT1086D Ornamental Triangle MOT1518A Reception immediately following the ceremony MOT1520A Floral Shape (on reply)
Inks	BLACK PLATINUM
Process	ENGRAVING
Lining	LIN135A Black (additional - price group HH)
Paper	PEARL WHITE KID FINISH®

R.S.V.P.

BY FEBRUARY TWENTIETH

(NAMES)

 HAPPILY
accepts

 SADLY
declines



PLEASE NOTE:

- Embassy invitations may require additional postage.
- Premium Weight papers are reserved for engraving or letterpress only.
- For painted edge treatments shown, orders need to indicate color choice and will require additional delivery time.

TIVOLI SUITE • PRICE GROUP F

PAPER CODE	DESCRIPTION	WEIGHT
59-LC9666	EMBASSY PREMIUM WEIGHT INVITATION	192#
59-W65	INSIDE ENVELOPE (ungummed, not shown)	32#
59-W85	OUTSIDE ENVELOPE (not shown)	32#
59-LE9116	SINGLE ENVELOPE	32#
59-LC1666	PREMIUM WEIGHT RESPONSE/RECEPTION CARD	192#
59-LE1116	RESPONSE ENVELOPE (not shown)	32#

DESIGN ELEMENTS

Lettering	LET704 (script) LET704W (swash)
Ink Edge	CLEMENTINE
Ink	GOLD
Process	ENGRAVING
Lining	LIN309C Red Florentine (additional - price group HH)
Paper	ECRU KID FINISH®

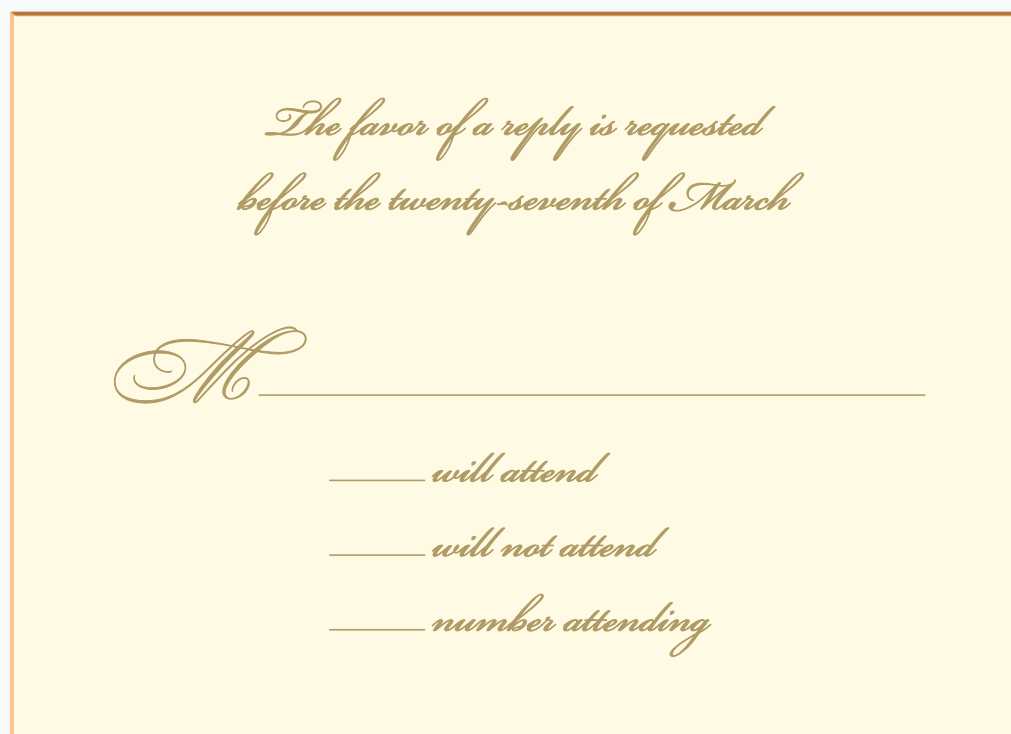



*José Hernández Caratini
Carmen María de Hernández*

*y
Juan Martínez Parza
Consuelo Elena de Mercado
tienen el honor de invitarle
al matrimonio de sus hijos*

Sophía

y

Joaquín

*el sábado, veinte de marzo
de mil veintiuno
a las dos de la tarde
Santa Sofía Cathedral
San Juan de Puerto Rico*

*José Hernández Caratini
Carmen María de Hernández*

*and
Juan Martínez Parza
Consuelo Elena de Mercado
request the honor of your presence
at the marriage uniting their children*

Sophía Hernández

and

Joaquín Mercado

*Saturday, the twentieth of March
two thousand twenty-one
at two o'clock in the afternoon
Santa Sofía Cathedral
San Juan, Puerto Rico*

INSIDE FOLDER

PLEASE NOTE:

- Royalty folders will require additional postage.



*Por favor, responda antes del veinte de febrero
Kindly respond by the twentieth of February*

CHESHIRE SUITE • PRICE GROUP K

PAPER CODE	DESCRIPTION	WEIGHT
59-LF0111	ROYALTY INVITATION	64#
59-W13	INSIDE ENVELOPE (ungummed, not shown)	32#
59-W33	OUTSIDE ENVELOPE (not shown)	32#
59-LE0111	SINGLE ENVELOPE	32#
59-LC1111	RESPONSE/RECEPTION CARD (shown 2 color)	96#
59-LE1111	RESPONSE ENVELOPE (not shown)	32#

DESIGN ELEMENTS

Lettering	LET721
Monograms	MON439D (on invite) MON439C (on reply)
Inks	GOLD, CHARCOAL
Processes	THERMOGRAPHY FLAT (invite inside)
Lining	LIN178B Gold Lustre (additional - price group HH)
Paper	PEARL WHITE KID FINISH®



GOLD BEVEL KENT CARD • PRICE GROUP S

PAPER CODE	DESCRIPTION	WEIGHT
59-GB3116	GOLD BEVEL MENU CARD	96#

DESIGN ELEMENTS

Lettering	LET520 (block, shown all small caps with letter spacing added) LET705 (script)
Motifs	MOT1110A Menu MOT1404B Sweeping Flourish
Ink	GOLD
Process	ENGRAVING
Paper	ECRU KID FINISH®

MONARCH CARD • PRICE GROUP P

PAPER CODE	DESCRIPTION	WEIGHT
59-LC7116	ECRU MENU CARD	96#
59-LC7111	PEARL WHITE MENU CARD (not shown)	96#

DESIGN ELEMENTS

Lettering	LET609S (block) LET728 (script)
Monogram	MON529B
Motifs	MOT1525A Salad MOT1526A Entrées MOT1527A Dessert
Ink	TAUPE
Process	ENGRAVING
Paper	ECRU KID FINISH®



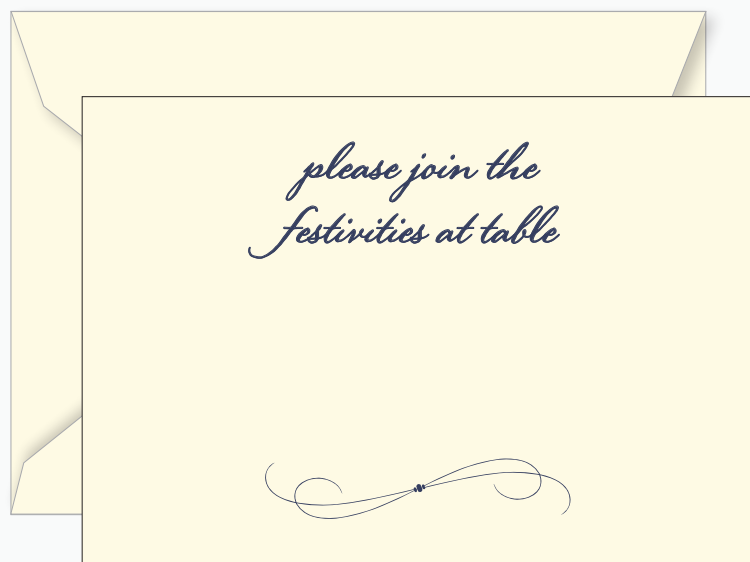

PAPER CODE	DESCRIPTION	WEIGHT	PRICE GROUP
59-V31-130	ECRU TABLE CARD	96#	EE
59-E82-130	TABLE CARD ENVELOPE	32#	EE

DESIGN ELEMENTS

Lettering	T390
Motif	MOT1404A Sweeping Flourish
Ink	NAVY
Process	THERMOGRAPHY
Paper	ECRU KID FINISH®

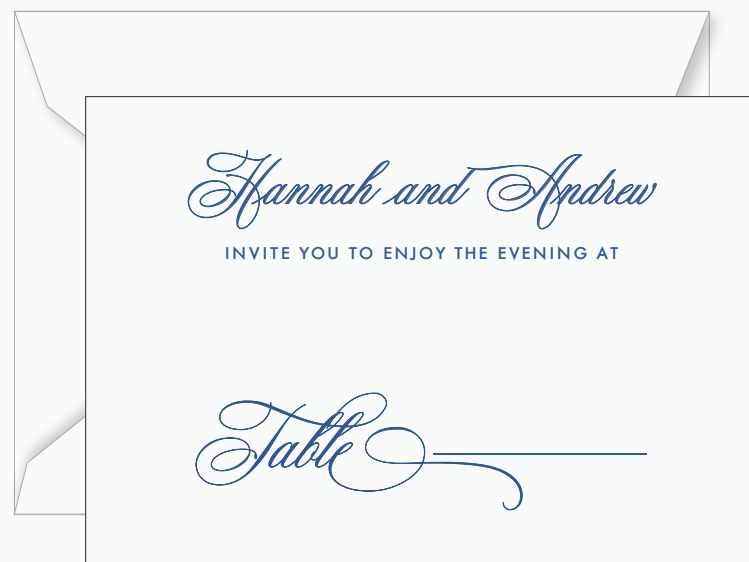

PAPER CODE	DESCRIPTION	WEIGHT	PRICE GROUP
59-V30-130	PEARL WHITE TABLE CARD	96#	EE
59-E91-130	TABLE CARD ENVELOPE	32#	EE

DESIGN ELEMENTS

Lettering	LET728 (script), LET609S (block)
Motif	MOT1528A Table
Ink	REGENT BLUE
Process	THERMOGRAPHY
Paper	PEARL WHITE KID FINISH®

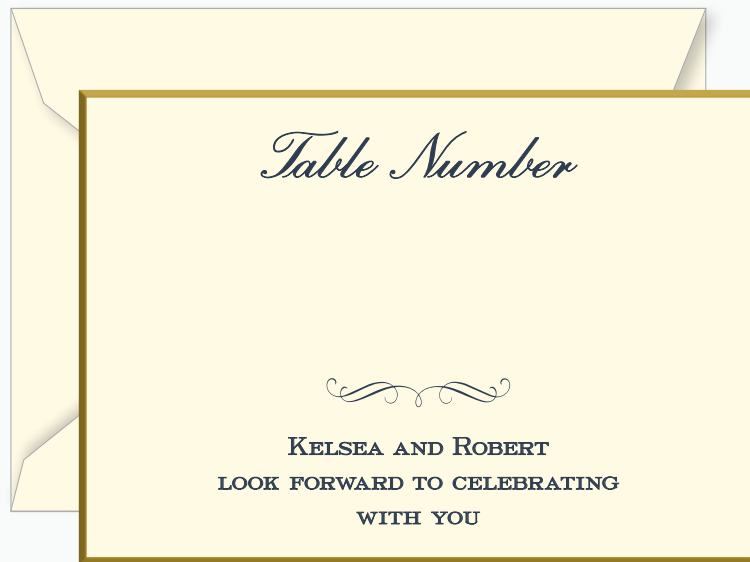

PAPER CODE	DESCRIPTION	WEIGHT	PRICE GROUP
59-GB31-130	GOLD BEVEL TABLE CARD	96#	FF
59-E82-130	TABLE CARD ENVELOPE	32#	FF

DESIGN ELEMENTS

Lettering	LET716 (script), LET513 (block)
Motif	MOT570D Swirl
Ink	CHARCOAL
Process	ENGRAVING
Paper	ECRU KID FINISH®

PLEASE NOTE:

- The Gold Bevel Table Card is reserved for engraving or blind embossing only.

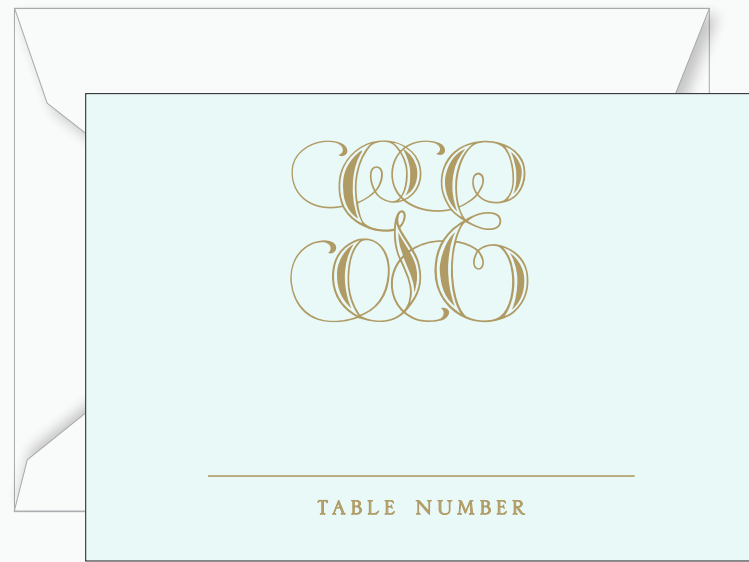

PAPER CODE	DESCRIPTION	WEIGHT	PRICE GROUP
59-V19-130	BEACH GLASS TABLE CARD	96#	EE
59-E91-130	TABLE CARD ENVELOPE	32#	EE

DESIGN ELEMENTS

Lettering	LET520 (shown all small caps with letter spacing added)
Monogram	MON439A
Ink	GOLD
Process	ENGRAVING
Paper	BEACH GLASS KID FINISH®, PEARL WHITE KID FINISH®

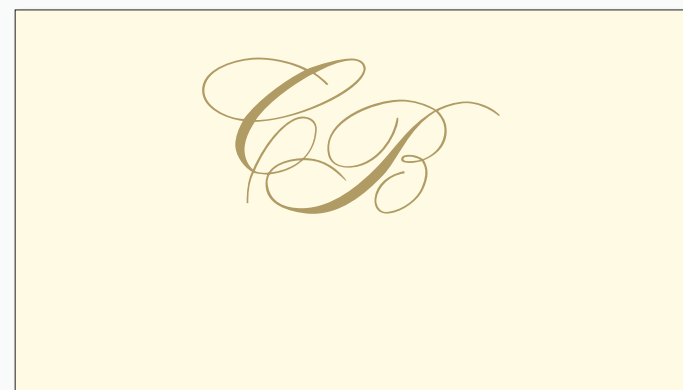

PAPER CODE	DESCRIPTION	WEIGHT	PRICE GROUP
59-T84-124	ECRU PLACE CARD	64#	EE
59-E82-124	PLACE CARD ENVELOPE (not shown)	32#	EE

DESIGN ELEMENTS

Monogram	MON542A
Ink	GOLD
Process	ENGRAVING
Paper	ECRU KID FINISH®



PAPER CODE	DESCRIPTION	WEIGHT	PRICE GROUP
59-T91-124	PEARL WHITE PLACE CARD	64#	EE
59-E91-124	PLACE CARD ENVELOPE (not shown)	32#	EE

DESIGN ELEMENTS

Lettering	LET716
Motif	MOT1116B Calligraphy Flourish
Ink	FRENCH BLUE
Process	THERMOGRAPHY
Paper	PEARL WHITE KID FINISH®

Crane

DESIGN ELEMENTS

CRANE PAPERS

PLEASE NOTE:

- PREMIUM WEIGHT 192# KID FINISH AND 110# AND 220# LETTRA PAPERS ARE RESERVED FOR ENGRAVING OR LETTERPRESS PRINTING ONLY.
- INSIDE ENVELOPES WILL BE SUPPLIED UNGUMMED.
- DOUBLE ENVELOPES ARE NOT AVAILABLE FOR COLORED PAPERS.

PAPER CODE	FORMAT	COLOR	FINISH	WEIGHT	MEASUREMENTS
ROYALTY (SIZE 50)					
LC0101	Flat Card	Pearl White	Kid	96#	6 3/16" x 8 7/8"
LC0141	Pearl Frame Flat Card	Pearl White	Kid	96#	6 3/16" x 8 7/8"
LC0871	Gold Triple Border Frame Flat Card	Pearl White	Kid	96#	6 3/16" x 8 7/8"
LCR0161	Premium Weight Flat Card	Pearl White	Kid	192#	6 3/16" x 8 13/16"
LCR0161LB	Premium Weight Flat Card Oversized for Luxury Bevel	Pearl White	Kid	192#	6 3/16" x 8 13/16"
LCR0201	Premium Weight Flat Card with Silver Bevel	Pearl White	Kid	192#	6 3/16" x 8 13/16"
LCR0361	Premium Weight Flat Card with Gilt Edge	Pearl White	Kid	192#	6 3/16" x 8 13/16"
LF0111	Folder	Pearl White	Kid	64#	6 3/16" x 8 3/4"
W13	Inside Envelope	Pearl White	Kid	32#	6 3/8 x 9 3/16"
W33	Outside Envelope	Pearl White	Kid	32#	6 9/16 x 9 7/16"
LE0111	Single Envelope	Pearl White	Kid	32#	6 3/8 x 9 3/16"
LC0721	Flat Card	Pearl White	Lettra	110#	6 3/16" x 8 7/8"
LCR0261	Premium Weight Flat Card	Pearl White	Lettra	220#	6 3/16" x 8 13/16"
W54	Inside Envelope	Pearl White	Lettra	32#	6 3/8 x 9 3/16"
W55	Outside Envelope	Pearl White	Lettra	32#	6 9/16 x 9 7/16"
LE0721	Single Envelope	Pearl White	Lettra	32#	6 3/8 x 9 3/16"
LC0106	Flat Card	Ecru	Kid	96#	6 3/16" x 8 7/8"
LC0116	Flat Card with Gold Bevel	Ecru	Kid	96#	6 3/16" x 8 7/8"
LC0456	Classic Embossed Flat Card	Ecru	Kid	96#	6 3/16" x 8 7/8"
LC0536	Beveled Panel Flat Card	Ecru	Kid	96#	6 3/16" x 8 7/8"
LCR0166	Premium Weight Flat Card	Ecru	Kid	192#	6 3/16" x 8 13/16"
LCR0166LB	Premium Weight Flat Card Oversized for Luxury Bevel	Ecru	Kid	192#	6 3/16" x 8 13/16"
LCR0206	Premium Weight Flat Card with Gold Bevel	Ecru	Kid	192#	6 3/16" x 8 13/16"
LCR0366	Premium Weight Flat Card with Gilt Edge	Ecru	Kid	192#	6 3/16" x 8 13/16"
LCR0446	Premium Weight Stately Corners Flat Card	Ecru	Kid	192#	6 3/16" x 8 13/16"
LCR0996	Premium Weight Gold Ink Edged Flat Card	Ecru	Kid	192#	6 3/16" x 8 13/16"
LF0116	Folder	Ecru	Kid	64#	6 3/16" x 8 3/4"
W17	Inside Envelope	Ecru	Kid	32#	6 3/8 x 9 3/16"
W37	Outside Envelope	Ecru	Kid	32#	6 9/16 x 9 7/16"
LE0116	Single Envelope	Ecru	Kid	32#	6 3/8 x 9 3/16"
LC0726	Flat Card	Ecru	Lettra	110#	6 3/16" x 8 7/8"
LCR0266	Premium Weight Flat Card	Ecru	Lettra	220#	6 3/16" x 8 13/16"
W57	Inside Envelope	Ecru	Lettra	32#	6 3/8 x 9 3/16"
W59	Outside Envelope	Ecru	Lettra	32#	6 9/16 x 9 7/16"
LE0726	Single Envelope	Ecru	Lettra	32#	6 3/8 x 9 3/16"
LC0322	Flat Card	Beach Glass	Kid	96#	6 3/16" x 8 7/8"
LCR0322	Premium Weight Flat Card	Beach Glass	Kid	192#	6 3/16" x 8 13/16"
LE0322	Single Envelope	Beach Glass	Kid	32#	6 3/8 x 9 3/16"

W-2022

PAPER CODE	FORMAT	COLOR	FINISH	WEIGHT	MEASUREMENTS
EMBASSY (SIZE 9)					
LC9111	Flat Card	Pearl White	Kid	96#	5 1/2" x 7 1/2"
LC9061	Premium Weight Flat Card with Gilt Edge	Pearl White	Kid	192#	5 1/2" x 7 7/16"
LC9531	Beveled Panel Flat Card	Pearl White	Kid	96#	5 1/2" x 7 1/2"
LC9661	Premium Weight Flat Card	Pearl White	Kid	192#	5 1/2" x 7 7/16"
LC9921	Premium Weight Flat Card with Gold Bevel	Pearl White	Kid	192#	5 1/2" x 7 7/16"
LC9981	Beaded Frame Flat Card	Pearl White	Kid	96#	5 1/2" x 7 1/2"
C9111PLT	Platinum Bordered Flat Card	Pearl White	Kid	96#	5 1/2" x 7 1/2"
C9111NVY	Navy Bordered Flat Card	Pearl White	Kid	96#	5 1/2" x 7 1/2"
GB9111	Flat Card with Gold Bevel	Pearl White	Kid	96#	5 1/2" x 7 1/2"
GB9121	Flat Card with Gold Bevel Round Corner	Pearl White	Kid	96#	5 1/2" x 7 1/2"
SB9111	Flat Card with Silver Bevel	Pearl White	Kid	96#	5 1/2" x 7 1/2"
SB9121	Flat Card with Silver Bevel Round Corner	Pearl White	Kid	96#	5 1/2" x 7 1/2"
SB9201	Premium Weight Flat Card with Silver Bevel	Pearl White	Kid	192#	5 1/2" x 7 7/16"
LF9111	Folder	Pearl White	Kid	64#	5 1/2" x 7 3/8"
W60	Inside Envelope	Pearl White	Kid	32#	5 3/4 X 7 11/16"
W80	Outside Envelope	Pearl White	Kid	32#	5 7/8 X 7 7/8"
LE9111	Single Envelope	Pearl White	Kid	32#	5 3/4" x 7 11/16"
LC9821	Flat Card	Pearl White	Lettra	110#	5 1/2" x 7 1/2"
LC9781	Elegant Frame Flat Card	Pearl White	Lettra	110#	5 1/2" x 7 1/2"
LC9901	Premium Weight Flat Card	Pearl White	Lettra	220#	5 1/2" x 7 7/16"
W90	Inside Envelope	Pearl White	Lettra	32#	5 3/4" x 7 11/16"
W91	Outside Envelope	Pearl White	Lettra	32#	5 7/8" x 7 7/8"
LE9821	Single Envelope	Pearl White	Lettra	32#	5 3/4" x 7 11/16"
LC9116	Flat Card	Ecru	Kid	96#	5 1/2" x 7 1/2"
LC9066	Premium Weight Flat Card with Gilt Edge	Ecru	Kid	192#	5 1/2" x 7 7/16"
LC9516	Pearl and Beveled Panel Flat Card	Ecru	Kid	96#	5 1/2" x 7 1/2"
LC9556	Embossed Frame Flat Card	Ecru	Kid	96#	5 1/2" x 7 1/2"
LC9666	Premium Weight Flat Card	Ecru	Kid	192#	5 1/2" x 7 7/16"
LC9986	Beaded Frame Flat Card	Ecru	Kid	96#	5 1/2" x 7 1/2"
C9116GLD	Gold Bordered Flat Card	Ecru	Kid	96#	5 1/2" x 7 1/2"
C9116PRL	Pearl Bordered Flat Card	Ecru	Kid	96#	5 1/2" x 7 1/2"
C9116RGD	Rose Gold Bordered Flat Card	Ecru	Kid	96#	5 1/2" x 7 1/2"
GB9116	Flat Card with Gold Bevel	Ecru	Kid	96#	5 1/2" x 7 1/2"
GB9126	Flat Card with Gold Bevel Round Corner	Ecru	Kid	96#	5 1/2" x 7 1/2"
GB9206	Premium Weight Flat Card with Gold Bevel	Ecru	Kid	192#	5 1/2" x 7 7/16"
LF9116	Folder	Ecru	Kid	64#	5 1/2" x 7 3/8"
W88	French Fold Wedding Sheet	Ecru	Kid	40#	5 1/2" x 7 1/2"
W65	Inside Envelope	Ecru	Kid	32#	5 3/4" x 7 11/16"
W85	Outside Envelope	Ecru	Kid	32#	5 7/8" x 7 7/8"
LE9116	Single Envelope	Ecru	Kid	32#	5 3/4" x 7 11/16"
LC9826	Flat Card	Ecru	Lettra	110#	5 1/2" x 7 1/2"
LC9906	Premium Weight Flat Card	Ecru	Lettra	220#	5 1/2" x 7 7/16"
W95	Inside Envelope	Ecru	Lettra	32#	5 3/4" x 7 11/16"
W96	Outside Envelope	Ecru	Lettra	32#	5 7/8" x 7 7/8"
LE9326	Single Envelope	Ecru	Lettra	32#	5 3/4" x 7 11/16"
LC9322	Flat Card	Beach Glass	Kid	96#	5 1/2" x 7 1/2"
LE9322	Single Envelope	Beach Glass	Kid	32#	5 3/4" x 7 11/16"

W-2022

PAPER CODE	FORMAT	COLOR	FINISH	WEIGHT	MEASUREMENTS
MARQUIS (SIZE 80)					
LCM111	Flat Card	Pearl White	Kid	96#	6 3/4" x 6 3/4"
LEM131	Inside Envelope	Pearl White	Kid	32#	7" x 7"
LEM141	Outside Envelope	Pearl White	Kid	32#	7 5/16" x 7 5/16"
LEM131G	Single Envelope	Pearl White	Kid	32#	7" x 7"
LCM116	Flat Card	Ecru	Kid	96#	6 3/4" x 6 3/4"
LCM106	Trailing Leaves Flat Card	Ecru	Kid	96#	6 3/4" x 6 3/4"
LEM136	Inside Envelope	Ecru	Kid	32#	7" x 7"
LEM146	Outside Envelope	Ecru	Kid	32#	7 5/16" x 7 5/16"
LEM136G	Single Envelope	Ecru	Kid	32#	7" x 7"
KENT (SIZE 3)					
LC3111	Flat Card	Pearl White	Kid	96#	4 1/4" x 6 3/8"
LC3011	Embossed Pantheon Flat Card	Pearl White	Kid	96#	4 1/4" x 6 3/8"
LC31121	Bar Panel Flat Card	Pearl White	Kid	96#	4 1/4" x 6 3/8"
GB3111	Flat Card with Gold Bevel	Pearl White	Kid	96#	4 1/4" x 6 3/8"
LC3281	Bevel Panel Flat Card	Pearl White	Kid	96#	4 1/4" x 6 3/8"
LC3411	Embossed Pebble Frame Flat Card	Pearl White	Kid	96#	4 1/4" x 6 3/8"
C3111BLK	Black Bordered Flat Card	Pearl White	Kid	96#	4 1/4" x 6 3/8"
C3111CHAR	Charcoal Bordered Flat Card	Pearl White	Kid	96#	4 1/4" x 6 3/8"
C3111GLD	Gold Bordered Flat Card	Pearl White	Kid	96#	4 1/4" x 6 3/8"
C3111HGRN	Hunter Green Bordered Flat Card	Pearl White	Kid	96#	4 1/4" x 6 3/8"
C3111NVY	Navy Bordered Flat Card	Pearl White	Kid	96#	4 1/4" x 6 3/8"
C3111NWP	Newport Blue Bordered Flat Card	Pearl White	Kid	96#	4 1/4" x 6 3/8"
C3111PLT	Platinum Bordered Flat Card	Pearl White	Kid	96#	4 1/4" x 6 3/8"
C3111RED	Red Bordered Flat Card	Pearl White	Kid	96#	4 1/4" x 6 3/8"
C3111RGB	Regent Blue Bordered Flat Card	Pearl White	Kid	96#	4 1/4" x 6 3/8"
GB3201	Premium Weight Flat Card with Gold Bevel	Pearl White	Kid	192#	4 1/4" x 6 3/8"
LF3111	Heavyweight Note	Pearl White	Kid	64#	4 1/4" x 6 1/4"
LF31121	Bar Panel Heavyweight Note	Pearl White	Kid	64#	4 1/4" x 6 1/4"
LF31271	Embossed Pantheon Heavyweight Note	Pearl White	Kid	64#	4 1/4" x 6 1/4"
LH3111	Half Sheet	Pearl White	Kid	32#	6 3/8" x 8 1/2"
LH3281	Bevel Panel Half Sheet	Pearl White	Kid	32#	6 3/8" x 8 1/2"
H3111NWP	Newport Blue Bordered Half Sheet	Pearl White	Kid	32#	6 3/8" x 8 1/2"
LE3111	Envelope	Pearl White	Kid	32#	4 3/8" x 6 9/16"
LE3721	Newport Blue Bordered Envelope	Pearl White	Kid	32#	4 3/8" x 6 9/16"
LC3821	Flat Card	Pearl White	Lettra	110#	4 1/4" x 6 3/8"
LH3821	Half Sheet	Pearl White	Lettra	32#	6 3/8" x 8 1/2"
LE3821	Envelope	Pearl White	Lettra	32#	4 3/8" x 6 9/16"
LC3208	Flat Card	Fluorescent White	Kid	96#	4 1/4" x 6 3/8"
LH3208	Half Sheet	Fluorescent White	Kid	32#	6 3/8" x 8 1/2"
LE3208	Envelope	Fluorescent White	Kid	32#	4 3/8" x 6 9/16"
LC3116	Flat Card	Ecru	Kid	96#	4 1/4" x 6 3/8"
GB3116	Flat Card with Gold Bevel	Ecru	Kid	96#	4 1/4" x 6 3/8"
GB3126	Flat Card with Gold Bevel and Round Corners	Ecru	Kid	96#	4 1/4" x 6 3/8"
LC3286	Bevel Panel Flat Card	Ecru	Kid	96#	4 1/4" x 6 3/8"
LC30626	Rounded Bar Panel Flat Card	Ecru	Kid	96#	4 1/4" x 6 3/8"
LC31126	Bar Panel Flat Card	Ecru	Kid	96#	4 1/4" x 6 3/8"
LC3186	Embossed Bevel Frame Flat Card	Ecru	Kid	96#	4 1/4" x 6 3/8"

W-2022

PAPER CODE	FORMAT	COLOR	FINISH	WEIGHT	MEASUREMENTS
LC3416	Embossed Pebble Frame Flat Card	Ecru	Kid	96#	4 1/4" x 6 3/8"
LC3016	Embossed Pantheon Flat Card	Ecru	Kid	96#	4 1/4" x 6 3/8"
C3116BLK	Black Bordered Flat Card	Ecru	Kid	96#	4 1/4" x 6 3/8"
C3116CHAR	Charcoal Bordered Flat Card	Ecru	Kid	96#	4 1/4" x 6 3/8"
C3116GLD	Gold Bordered Flat Card	Ecru	Kid	96#	4 1/4" x 6 3/8"
C3116HGRN	Hunter Green Bordered Flat Card	Ecru	Kid	96#	4 1/4" x 6 3/8"
C3116NVY	Navy Bordered Flat Card	Ecru	Kid	96#	4 1/4" x 6 3/8"
C3116PLT	Platinum Bordered Flat Card	Ecru	Kid	96#	4 1/4" x 6 3/8"
C3116RED	Red Bordered Flat Card	Ecru	Kid	96#	4 1/4" x 6 3/8"
C3116REG	Regent Blue Bordered Flat Card	Ecru	Kid	96#	4 1/4" x 6 3/8"
GB3206	Premium Weight Flat Card with Gold Bevel	Ecru	Kid	192#	4 1/4" x 6 3/8"
LF3116	Heavyweight Note	Ecru	Kid	64#	4 1/4" x 6 1/4"
LF31126	Bar Panel Heavyweight Note	Ecru	Kid	64#	4 1/4" x 6 1/4"
LF31276	Embossed Pantheon Heavyweight Note	Ecru	Kid	64#	4 1/4" x 6 1/4"
LH3116	Half Sheet	Ecru	Kid	32#	6 3/8" x 8 1/2"
LH3286	Bevel Panel Half Sheet	Ecru	Kid	32#	6 3/8" x 8 1/2"
LH30626	Rounded Bar Panel Half Sheet	Ecru	Kid	32#	6 3/8" x 8 1/2"
LH3016	Embossed Pantheon Half Sheet	Ecru	Kid	32#	6 3/8" x 8 1/2"
H3116CHAR	Charcoal Bordered Half Sheet	Ecru	Kid	32#	6 3/8" x 8 1/2"
H3116NVY	Navy Bordered Half Sheet	Ecru	Kid	32#	6 3/8" x 8 1/2"
H3116RED	Red Bordered Half Sheet	Ecru	Kid	32#	6 3/8" x 8 1/2"
H3116REG	Regent Blue Bordered Half Sheet	Ecru	Kid	32#	6 3/8" x 8 1/2"
LE3116	Envelope	Ecru	Kid	32#	4 3/8" x 6 9/16"
LC3826	Flat Card	Ecru	Lettra	110#	4 1/4" x 6 3/8"
LH3826	Half Sheet	Ecru	Lettra	32#	6 3/8" x 8 1/2"
LE3826	Envelope	Ecru	Lettra	32#	4 3/8" x 6 9/16"
LC3322	Flat Card	Beach Glass	Kid	96#	4 1/4" x 6 3/8"
LH3322	Half Sheet	Beach Glass	Kid	32#	6 3/8" x 8 1/2"
LE3322	Envelope	Beach Glass	Kid	32#	4 3/8" x 6 9/16"
LC3112	Flat Card	Light Gray	Impress	110C	4 1/4" x 6 3/8"
LH3112	Half Sheet	Light Gray	Impress	32W	6 3/8" x 8 1/2"
LE3112	Envelope	Light Gray	Impress	32W	4 3/8" x 6 9/16"
CORINNE (SIZE 1)					
LC1111	Flat Card	Pearl White	Kid	96#	3 13/16" x 5 5/16"
LC1141	Pearl Frame Flat Card	Pearl White	Kid	96#	3 13/16" x 5 5/16"
LC1531	Beveled Panel Flat Card	Pearl White	Kid	96#	3 13/16" x 5 5/16"
LC1871	Gold Triple Border Frame Flat Card	Pearl White	Kid	96#	3 13/16" x 5 5/16"
LC1981	Beaded Frame Flat Card	Pearl White	Kid	96#	3 13/16" x 5 5/16"
C1111NVY	Navy Bordered Flat Card	Pearl White	Kid	96#	3 13/16" x 5 5/16"
C1111PLT	Platinum Bordered Flat Card	Pearl White	Kid	96#	3 13/16" x 5 5/16"
GB1111	Flat Card with Gold Bevel	Pearl White	Kid	96#	3 13/16" x 5 5/16"
GB1121	Flat Card with Gold Bevel Round Cornered	Pearl White	Kid	96#	3 13/16" x 5 5/16"
SB1111	Flat Card with Silver Bevel	Pearl White	Kid	96#	3 13/16" x 5 5/16"
SB1201	Flat Card with Silver Bevel Round Cornered	Pearl White	Kid	96#	3 13/16" x 5 5/16"
LC1661	Premium Weight Flat Card	Pearl White	Kid	192#	3 13/16" x 5 1/4"
LC1061	Premium Weight Flat Card with Gilt Edge	Pearl White	Kid	192#	3 13/16" x 5 1/4"
LC1921	Premium Weight Flat Card with Gold Bevel	Pearl White	Kid	192#	3 13/16" x 5 1/4"
LC1941	Premium Weight Flat Card with Silver Bevel	Pearl White	Kid	192#	3 13/16" x 5 1/4"

W-2022

PAPER CODE	FORMAT	COLOR	FINISH	WEIGHT	MEASUREMENTS
CORINNE (SIZE 1) CONTINUED					
LN1111	Note	Pearl White	Kid	32#	3 13/16" x 5 5/16"
LF1111	Heavyweight Note	Pearl White	Kid	64#	3 13/16" x 5 3/16"
LF1281	Beveled Panel Heavyweight Note	Pearl White	Kid	64#	3 13/16" x 5 3/16"
LF11121	Bar Panel Heavyweight Note	Pearl White	Kid	64#	3 13/16" x 5 3/16"
LF1011	Embossed Pantheon Heavyweight Note	Pearl White	Kid	64#	3 13/16" x 5 3/16"
LF1831	Embossed Cross Heavyweight Note	Pearl White	Kid	64#	3 13/16" x 5 3/16"
LF1861	Classic Star of David Heavyweight Note	Pearl White	Kid	64#	3 13/16" x 5 3/16"
F1111BLK	Black Bordered Heavyweight Note	Pearl White	Kid	64#	3 13/16" x 5 3/16"
F1111CHAR	Charcoal Bordered Heavyweight Note	Pearl White	Kid	64#	3 13/16" x 5 3/16"
F1111GLD	Gold Bordered Heavyweight Note	Pearl White	Kid	64#	3 13/16" x 5 3/16"
F1111HGRN	Hunter Green Bordered Heavyweight Note	Pearl White	Kid	64#	3 13/16" x 5 3/16"
F1111NVY	Navy Bordered Heavyweight Note	Pearl White	Kid	64#	3 13/16" x 5 3/16"
F1111PLT	Platinum Bordered Heavyweight Note	Pearl White	Kid	64#	3 13/16" x 5 3/16"
F1111RED	Red Bordered Heavyweight Note	Pearl White	Kid	64#	3 13/16" x 5 3/16"
F1111REG	Regent Blue Bordered Heavyweight Note	Pearl White	Kid	64#	3 13/16" x 5 3/16"
LE1111	Envelope	Pearl White	Kid	32#	3 15/16" x 5 9/16"
LC1721	Flat Card	Pearl White	Lettra	110#	3 13/16" x 5 5/16"
LC1901	Premium Weight Flat Card	Pearl White	Lettra	220#	3 13/16" x 5 1/4"
LC1781	Elegant Frame Flat Card	Pearl White	Lettra	110#	3 13/16" x 5 5/16"
LN1121	Note	Pearl White	Lettra	32#	3 13/16" x 5 5/16"
LF1721	Heavyweight Note	Pearl White	Lettra	110#	3 13/16" x 5 3/16"
LE1721	Envelope	Pearl White	Lettra	32#	3 15/16" x 5 9/16"
LC1208	Flat Card	Fluorescent White	Kid	96#	3 13/16" x 5 5/16"
LN1208	Note	Fluorescent White	Kid	32#	3 13/16" x 5 5/16"
LE1208	Envelope	Fluorescent White	Kid	32#	3 15/16" x 5 9/16"
LC1116	Flat Card	Ecru	Kid	96#	3 13/16" x 5 5/16"
LC1106	Trailing Leaves Flat Card	Ecru	Kid	96#	3 13/16" x 5 5/16"
LC1456	Classic Embossed Flat Card	Ecru	Kid	96#	3 13/16" x 5 5/16"
LC1536	Beveled Panel Flat Card	Ecru	Kid	96#	3 13/16" x 5 5/16"
LC1556	Embossed Frame Flat Card	Ecru	Kid	96#	3 13/16" x 5 5/16"
LC1986	Beaded Frame Flat Card	Ecru	Kid	96#	3 13/16" x 5 5/16"
C1116GLD	Gold Bordered Flat Card	Ecru	Kid	96#	3 13/16" x 5 5/16"
C1116PRL	Pearl Bordered Flat Card	Ecru	Kid	96#	3 13/16" x 5 5/16"
C1116RGD	Rose Gold Bordered Flat Card	Ecru	Kid	96#	3 13/16" x 5 5/16"
GB1116	Flat Card with Gold Bevel	Ecru	Kid	96#	3 13/16" x 5 5/16"
GB1126	Flat Card with Gold Bevel Round Corner	Ecru	Kid	96#	3 13/16" x 5 5/16"
LN1116	Note	Ecru	Kid	32#	3 13/16" x 5 5/16"
LF1116	Heavyweight Note	Ecru	Kid	64#	3 13/16" x 5 3/16"
LF1456	Classic Embossed Heavyweight Note	Ecru	Kid	64#	3 13/16" x 5 3/16"
LF11126	Bar Panel Heavyweight Note	Ecru	Kid	64#	3 13/16" x 5 3/16"
LF1016	Embossed Pantheon Heavyweight Note	Ecru	Kid	64#	3 13/16" x 5 3/16"
LF17436	Interlocking Emboss Frame Heavyweight Note	Ecru	Kid	64#	3 13/16" x 5 3/16"
LF1176	Beveled Frame Heavyweight Note	Ecru	Kid	64#	3 13/16" x 5 3/16"
LF1286	Bevel Panel Heavyweight Note	Ecru	Kid	64#	3 13/16" x 5 3/16"
LF1846	Classic Cross Heavyweight Note	Ecru	Kid	64#	3 13/16" x 5 3/16"
F1116BLK	Black Bordered Heavyweight Note	Ecru	Kid	64#	3 13/16" x 5 3/16"
F1116CHAR	Charcoal Bordered Heavyweight Note	Ecru	Kid	64#	3 13/16" x 5 3/16"

W-2022

PAPER CODE	FORMAT	COLOR	FINISH	WEIGHT	MEASUREMENTS
CORINNE (SIZE 1) CONTINUED					
F1116GLD	Gold Bordered Heavyweight Note	Ecru	Kid	64#	3 13/16" x 5 3/16"
F1116HGRN	Hunter Green Bordered Heavyweight Note	Ecru	Kid	64#	3 13/16" x 5 3/16"
F1116NVY	Navy Bordered Heavyweight Note	Ecru	Kid	64#	3 13/16" x 5 3/16"
F1116PLT	Platinum Bordered Heavyweight Note	Ecru	Kid	64#	3 13/16" x 5 3/16"
F1116RED	Red Bordered Heavyweight Note	Ecru	Kid	64#	3 13/16" x 5 3/16"
F1116REG	Regent Blue Bordered Heavyweight Note	Ecru	Kid	64#	3 13/16" x 5 3/16"
LC1666	Premium Weight Flat Card	Ecru	Kid	192#	3 13/16" x 5 1/4"
LC1066	Premium Weight Flat Card with Gilt Edge	Ecru	Kid	192#	3 13/16" x 5 1/4"
GB1206	Premium Weight Flat Card with Gold Bevel	Ecru	Kid	192#	3 13/16" x 5 1/4"
LC1446	Premium Weight Stately Corners Flat Card	Ecru	Kid	192#	3 13/16" x 5 1/4"
LC1996	Premium Weight Gold Ink Edged Flat Card	Ecru	Kid	192#	3 13/16" x 5 1/4"
LE1116	Envelope	Ecru	Kid	32#	3 15/16" x 5 9/16"
LC1026	Flat Card	Ecru	Lettra	110#	3 13/16" x 5 5/16"
LC1906	Premium Weight Flat Card	Ecru	Lettra	220#	3 13/16" x 5 1/4"
LN1126	Note	Ecru	Lettra	32#	3 13/16" x 5 5/16"
LF1326	Heavyweight Note	Ecru	Lettra	110#	3 13/16" x 5 5/16"
LE1326	Envelope	Ecru	Lettra	32#	3 15/16" x 5 9/16"
LC1322	Flat Card	Beach Glass	Kid	96#	3 13/16" x 5 5/16"
LN1322	Note	Beach Glass	Kid	32#	3 13/16" x 5 5/16"
LF1322	Heavyweight Note	Beach Glass	Kid	64#	3 13/16" x 5 3/16"
LE1322	Envelope	Beach Glass	Kid	32#	3 15/16" x 5 9/16"
LC1112	Flat Card	Light Gray	Impress	110C	3 13/16" x 5 5/16"
LF1112	Heavyweight Note	Light Gray	Impress	90C	3 13/16" x 5 3/16"
LE1112	Envelope	Light Gray	Impress	32W	3 15/16" x 5 9/16"
BUSINESS / CALLING CARD (SIZE 124)					
V91-124	Flat Card	Pearl White	Kid	64#	2" x 3 1/2"
T91-124	Tent Card	Pearl White	Kid	64#	2" x 3 1/2"
V30-124	Flat Card	Pearl White	Kid	96#	2" x 3 1/2"
V29-124	Premium Weight Flat Card	Pearl White	Kid	192#	2" x 3 1/2"
E91-124	Envelope	Pearl White	Kid	32#	2 1/4" x 3 5/8"
V95-124	Flat Card	Pearl White	Lettra	110#	2" x 3 1/2"
V97-124	Premium Weight Flat Card	Pearl White	Lettra	220#	2" x 3 1/2"
V84-124	Flat Card	Ecru	Kid	64#	2" x 3 1/2"
T84-124	Tent Card	Ecru	Kid	64#	2" x 3 1/2"
V31-124	Flat Card	Ecru	Kid	96#	2" x 3 1/2"
V98-124	Premium Weight Flat Card	Ecru	Kid	192#	2" x 3 1/2"
E82-124	Envelope	Ecru	Kid	32#	2 1/4" x 3 5/8"
V96-124	Flat Card	Ecru	Lettra	110#	2" x 3 1/2"
V26-124	Premium Weight Flat Card	Ecru	Lettra	220#	2" x 3 1/2"
V19-124	Flat Card	Beach Glass	Kid	96#	2" x 3 1/2"
V12-124	Flat Card	Light Gray	Impress	110C	2" x 3 1/2"
BUSINESS / CALLING CARD (SIZE 130)					
V91-130	Flat Card	Pearl White	Kid	64#	3 15/32" x 3 7/16"
T91-130	Tent Card	Pearl White	Kid	64#	2 15/32" x 3 7/16"
V30-130	Flat Card	Pearl White	Kid	96#	2 15/32" x 3 7/16"
V29-130	Premium Weight Flat Card	Pearl White	Kid	192#	2 15/32" x 3 7/16"
E91-130	Envelope	Pearl White	Kid	32#	2 5/8" x 3 5/8"

W-2022

PAPER CODE	FORMAT	COLOR	FINISH	WEIGHT	MEASUREMENTS
BUSINESS / CALLING CARD (SIZE 130) CONTINUED					
V95-130	Flat Card	Pearl White	Lettra	110#	2 15/32" x 3 7/16"
V97-130	Premium Weight Flat Card	Pearl White	Lettra	220#	2 15/32" x 3 7/16"
V99-130	Flat Card	Fluorescent White	Kid	96#	2 15/32" x 3 7/16"
V84-130	Flat Card	Ecru	Kid	64#	2 15/32" x 3 7/16"
T84-130	Tent Card	Ecru	Kid	64#	2 15/32" x 3 7/16"
V31-130	Flat Card	Ecru	Kid	96#	2 15/32" x 3 7/16"
GB31-130	Flat Card with Gold Bevel	Ecru	Kid	96#	2 15/32" x 3 7/16"
V98-130	Premium Weight Flat Card	Ecru	Kid	192#	2 15/32" x 3 7/16"
E82-130	Envelope	Ecru	Kid	32#	2 5/8" x 3 5/8"
V96-130	Flat Card	Ecru	Lettra	110#	2 15/32" x 3 7/16"
V26-130	Premium Weight Flat Card	Ecru	Lettra	220#	2 15/32" x 3 7/16"
V19-130	Flat Card	Beach Glass	Kid	96#	2 15/32" x 3 7/16"
V12-130	Flat Card	Light Gray	Impress	110C	2 15/32" x 3 7/16"
MONARCH (SIZE 7)					
LC7111	Flat Card	Pearl White	Kid	96#	3 13/16" x 7 5/16"
LS7111	Monarch Sheet	Pearl White	Kid	32#	7 1/4" x 10 1/2"
LE7111	Envelope	Pearl White	Kid	32#	3 15/16" x 7 1/2"
LC7116	Flat Card	Ecru	Kid	96#	3 13/16" x 7 5/16"
LC70626	Bar Panel Flat Card	Ecru	Kid	96#	3 13/16" x 7 5/16"
LS7116	Monarch Sheet	Ecru	Kid	32#	7 1/4" x 10 1/2"
LE7116	Envelope	Ecru	Kid	32#	3 15/16" x 7 1/2"
EXECUTIVE (SIZE 8)					
AS8111	Executive Sheet	Pearl White	Kid	32#	8 1/2" x 11"
AE8111	Envelope	Pearl White	Kid	32#	4 1/8" x 9 1/2"
AS8116	Executive Sheet	Ecru	Kid	32#	8 1/2" x 11"
AE8116	Envelope	Ecru	Kid	32#	4 1/8" x 9 1/2"
LS8112	Executive Sheet	Light Gray	Impress	32W	8 1/2" x 11"
LE8112	Envelope	Light Gray	Impress	32W	4 1/8" x 9 1/2"
JOTTERS					
JC-WHITE	Jotter Card	White	Vellum	80# Cover	3" x 5"
JC-ECRU	Jotter Card	Ecru	Vellum	80# Cover	3" x 5"

W-2022

EDGE TREATMENTS

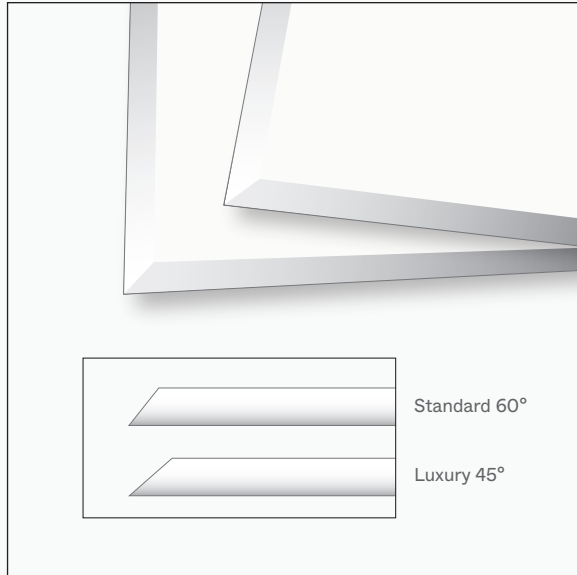

BEVEL EDGE
AVAILABLE IN STANDARD AND LUXURY BEVEL

THE SLANTED CUT EDGE OF A BEVEL GIVES A POLISHED LOOK TO STATIONERY AND INVITATIONS. BEVELS CAN BE APPLIED AT THE STANDARD 60 DEGREE OR THE STRIKING 45 DEGREE LUXURY BEVEL ON SELECT STOCKS. COLOR MAY BE ADDED TO A BEVEL EDGE WITH A CURATED SELECTION OF INK COLORS OR FOILS.

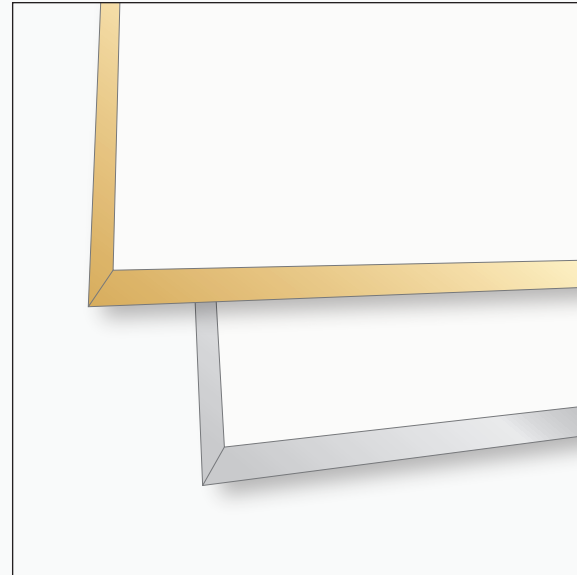

GILDED EDGE
AVAILABLE IN GOLD OR SILVER FOIL

GLEAMING METALLIC EDGES ADD A LUXURIOUS TOUCH THAT IS SURE TO BE REMEMBERED. GOLD OR SILVER FOIL MAY BE APPLIED TO A STRAIGHT OR BEVEL EDGE.

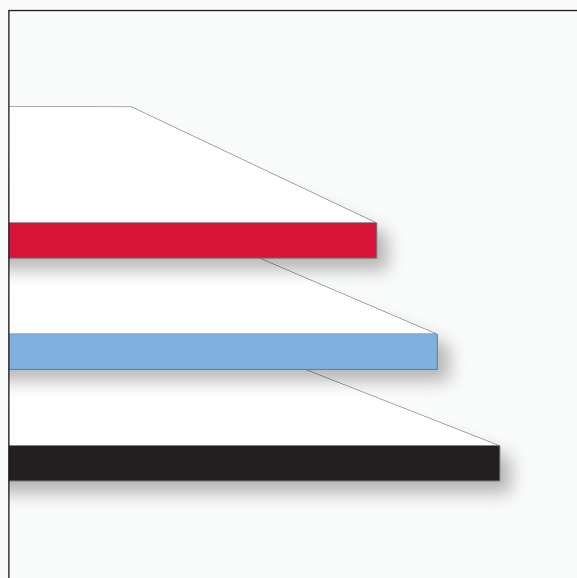

PAINTED EDGE
AVAILABLE IN SELECT CRANE ENGRAVING INK COLORS

STRAIGHT OR BEVELED EDGES GET A LITTLE EXTRA IMPACT WITH A DELIGHTFUL POP OF COLOR. CHOOSE FROM OUR CURATED ENGRAVING INK COLOR SELECTION TO APPLY INK TO THE CUT EDGE OF A CARD.

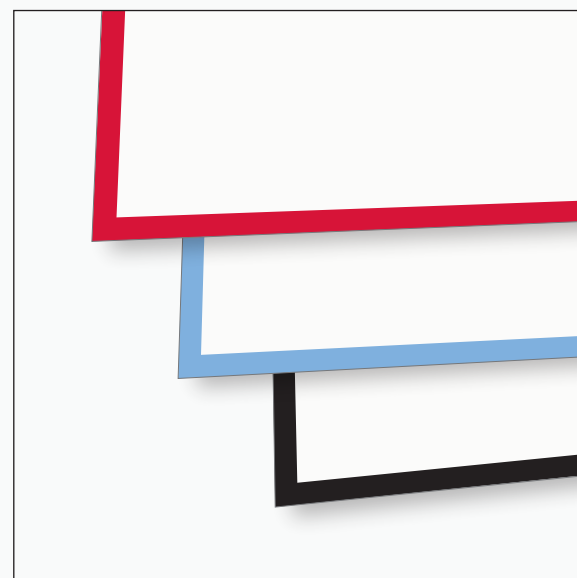

PAINTED BORDER
AVAILABLE IN A CURATED SELECTION OF COLORS

OUR PRE-BORDERED PAPERS ARE CRAFTED USING A FOUR-COLOR PRINTER TO ADD RICH COLOR TO THE OUTSIDE EDGES OF NOTES AND CARDS.

INKS



RED
(SCARLET)



BURGUNDY



PEONY
(PETAL PINK)



CLEMENTINE



MOSS GREEN



CLOVER



HUNTER GREEN
(FOREST GREEN)



PEACOCK



FRENCH BLUE



NEWPORT BLUE



MARINE BLUE



REGENT BLUE



NAVY
(INDIGO)



AMETHYST



RASPBERRY



KONA



MUSHROOM



TAUPE



GRAPHITE



CHARCOAL



PEWTER
(PEWTER GREY)

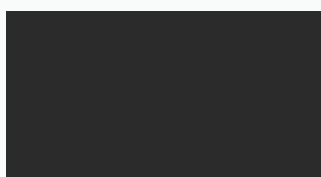

BLACK

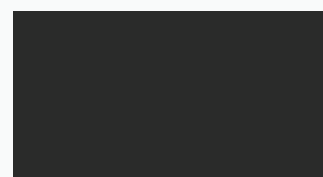

MIDNIGHT
(MATTE THERMOGRAPHY ONLY)

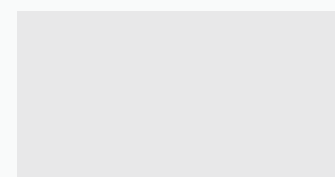

WHITE

METALLICS



POLISHED COPPER



GOLD
(SUN GOLD)



PLATINUM
(BRUSHED SILVER)



SILVER

ENVELOPE LININGS



SCARLET
LIN388A



MATTE BURGUNDY
LIN1012A

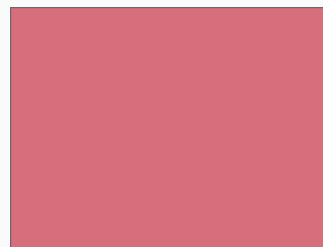

PEONY
LIN442A

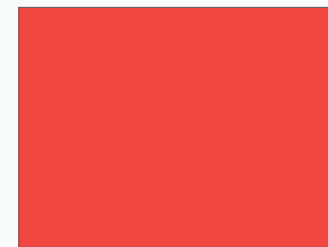

HIBISCUS
LIN466A



MOSS GREEN
LIN1073A



WOODLAND
LIN387A



HUNTER GREEN
LIN013A



PEACOCK
LIN266A



FRENCH BLUE
LIN051A

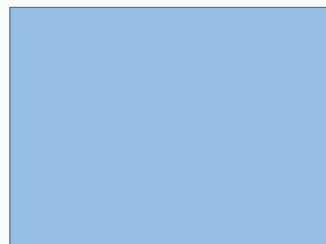

NEWPORT BLUE
LIN233A

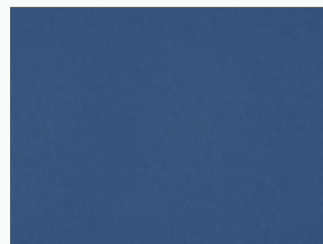

REGENT BLUE
LIN009A



NAVY
LIN131A



LILAC
LIN909A

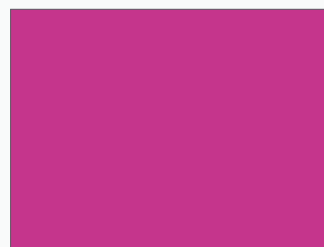

RASPBERRY
LIN058A



KONA
LIN098A

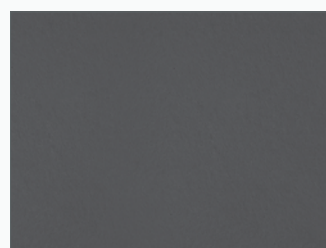

CHARCOAL
LIN017A

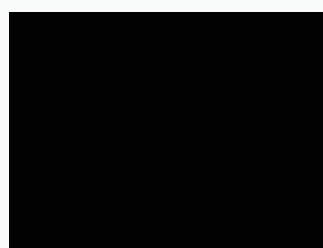

BLACK
LIN135A

ENVELOPE LININGS



GOLD LUSTRE
LIN178B



SATIN GOLD
LIN032A



SILVER LUSTRE
LIN177B



SILVER
LIN029A



ANTIQUE GOLD
LIN383A

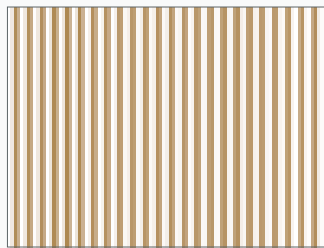

GOLD MICRO STRIPE
LIN284B

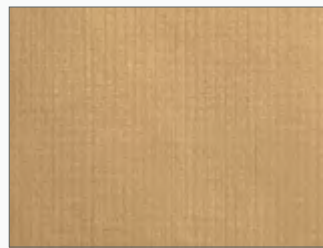

LINEN GOLD
LIN099D



GOLD STRIPES
LIN377B



ROSE GOLD
LIN792A



METALLIC GOLD
LIN443E



VINTAGE GOLD FLORAL
LIN445E

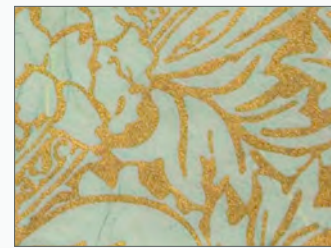

GOLD LEAVES ON GREEN
LIN200C



DAMASK CREAM
LIN469C



GOLD FOIL DAMASK
ON BLACK
LIN468C



GOLDEN SWIRL
LIN382D



GRAY FLORAL
LIN1078B



BLACK GEOMETRIC
LIN861B



BLACK & GOLD DECO
LIN452A

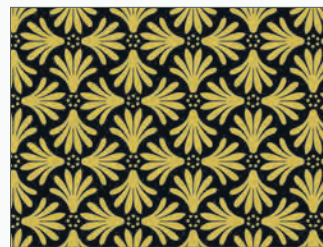

ELEGANT PALM
LIN394B

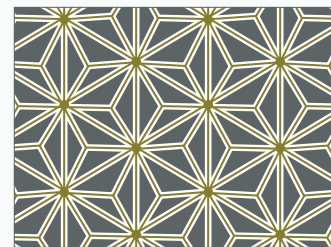

VINTAGE STARLIGHT
LIN397B

ENVELOPE LININGS

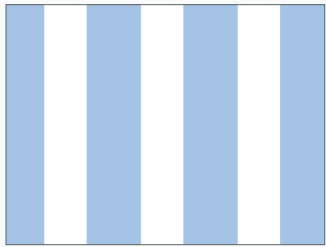

NEWPORT BLUE STRIPE
LIN432B

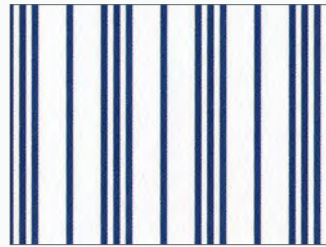

EXECUTIVE PINSTRIPE
LIN074B

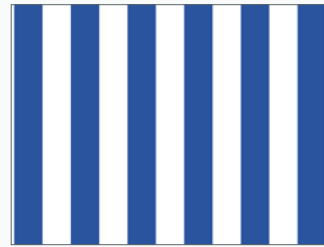

NAUTICAL STRIPE
LIN399B

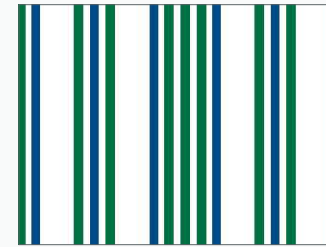

OXFORD STRIPE
LIN418B



BLUE HERRINGBONE
LIN372B

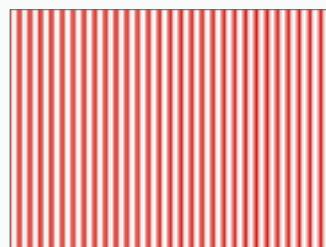

RED MICRO STRIPE
LIN467B

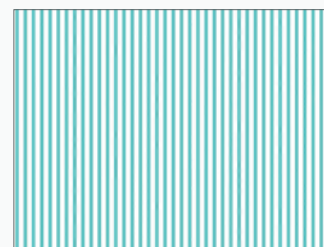

AQUA MICRO STRIPE
LIN286B

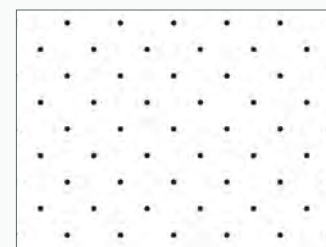

BLACK DOTS
LIN255B



PEWTER & GREEN STRIPE
LIN409B

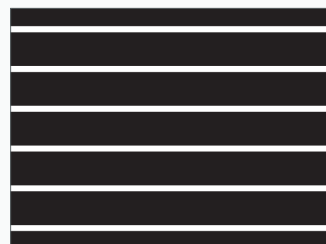

BLACK & WHITE STRIPE
LIN400B



PINK & GREEN STRIPE
LIN091B



VIBRANT LATTICE
LIN070B

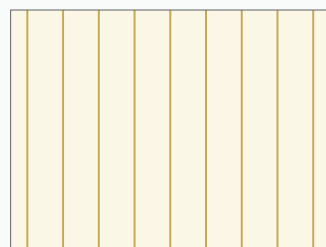

GOLD & ECRU PINSTRIPE
LIN798C

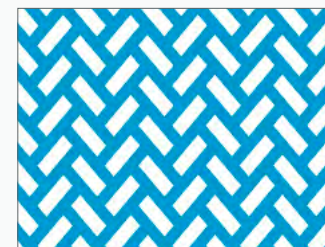

NEON BLUE HERRINGBONE
LIN864B



ORANGE & BLUE STRIPE
LIN089B



RED DIAGONAL
LIN841B

ENVELOPE LININGS



RED FLORENTINE
LIN309C



BLUE FLORENTINE
LIN381D



REGENCY
LIN292C



FLORENTINE GARDEN
LIN444J



DELFT
LIN845B



VINTAGE DAMASK
LIN039B

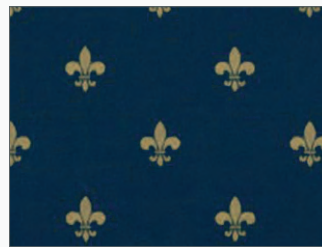

NAVY FLEUR DE LIS
LIN125B

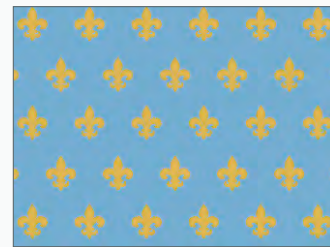

FLEUR DE LIS
LIN863B

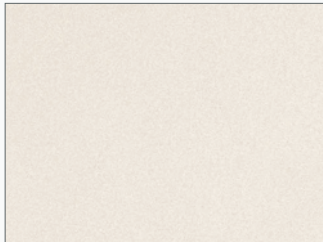

PEARL SHIMMER
LIN277B

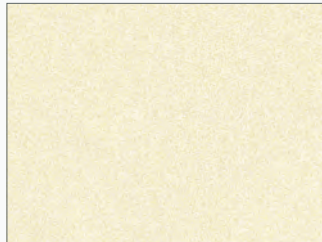

CHAMPAGNE SHIMMER
LIN278B

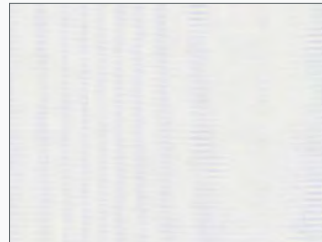

WHITE MOIRE
LIN123D

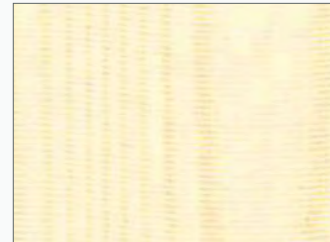

ECRU MOIRE
LIN122D

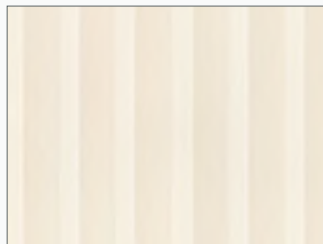

PEARL STRIPE
LIN391B



GREY & GOLD MARBLE
LIN490E

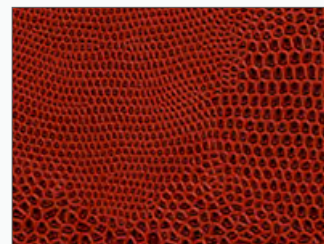

LIZARD
LIN049D



BLUE BONNET FLORAL
LIN1074B



LAUREL SPRIG
LIN1075B



FLORAL BOUQUET
LIN1076B



BLOSSOM
LIN1077B

LETTERING STYLES | Serif

AMERICANA BT
LET501

Mr. and Mrs. William Alexander Beckford
ABCDEFGHIJKLMNOPQRSTUVWXYZ
abcdefghijklmnopqrstuvwxyz & 1234567890

AMERICANA BT EXTRA BOLD
LET502

Mr. and Mrs. William Alexander Beckford
ABCDEFGHIJKLMNOPQRSTUVWXYZ
abcdefghijklmnopqrstuvwxyz & 1234567890

BAUER BODINI
T374

Mr. and Mrs. William Alexander Beckford
ABCDEFGHIJKLMNOPQRSTUVWXYZ
abcdefghijklmnopqrstuvwxyz & 1234567890

BEMBO ROMAN
LET543

Mr. and Mrs. William Alexander Beckford
ABCDEFGHIJKLMNOPQRSTUVWXYZ
abcdefghijklmnopqrstuvwxyz & 1234567890

CARLTON STD
LET503

Mr. and Mrs. William Alexander Beckford
ABCDEFGHIJKLMNOPQRSTUVWXYZ
abcdefghijklmnopqrstuvwxyz & 1234567890

CASLON OPEN FACE
T960

MR. AND MRS. WILLIAM ALEXANDER BECKFORD
ABCDEFGHIJKLMNOPQRSTUVWXYZ & 1234567890

CENTAUR MT
T873

Mr. and Mrs. William Alexander Beckford
ABCDEFGHIJKLMNOPQRSTUVWXYZ
abcdefghijklmnopqrstuvwxyz & 1234567890

CHEVALIER STD STRIPE
LET507

MR. AND MRS. WILLIAM ALEXANDER BECKFORD
ABCDEFGHIJKLMNOPQRSTUVWXYZ
ABCDEFGHIJKLMNOPQRSTUVWXYZ & 1234567890

LETTERING STYLES | Serif

COPPERPLATE GOTHIC 32
T880

MR. AND MRS. WILLIAM ALEXANDER BECKFORD
ABCDEFGHIJKLMNOPQRSTUVWXYZ
ABCDEFGHIJKLMNOPQRSTUVWXYZ & 1234567890

COPPERPLATE LIGHT CAP
LET510

MR. AND MRS. WILLIAM ALEXANDER BECKFORD
ABCDEFGHIJKLMNOPQRSTUVWXYZ & 1234567890

CORONET
LET506S

MR. AND MRS. WILLIAM ALEXANDER BECKFORD
ABCDEFGHIJKLMNOPQRSTUVWXYZ & 1234567890

DIDOT STD ROMAN
LET511

Mr. and Mrs. William Alexander Beckford
ABCDEFGHIJKLMNOPQRSTUVWXYZ
abcdefghijklmnopqrstuvwxyz & 1234567890

DOVER HMK
T493

Mr. and Mrs. William Alexander Beckford
ABCDEFGHIJKLMNOPQRSTUVWXYZ
abcdefghijklmnopqrstuvwxyz & 1234567890

ENG OP AMADEUS
T168

Mr. and Mrs. William Alexander Beckford
ABCDEFGHIJKLMNOPQRSTUVWXYZ
abcdefghijklmnopqrstuvwxyz & 1234567890

ENGRAVERS BOLD ROMAN
LET512

MR. AND MRS. WILLIAM ALEXANDER BECKFORD
ABCDEFGHIJKLMNOPQRSTUVWXYZ
ABCDEFGHIJKLMNOPQRSTUVWXYZ & 1234567890

FRANCO ROMAN
T138

MR. AND MRS. WILLIAM ALEXANDER BECKFORD
ABCDEFGHIJKLMNOPQRSTUVWXYZ
ABCDEFGHIJKLMNOPQRSTUVWXYZ & 1234567890

LETTERING STYLES | Serif

LIGHT FRENCH ROMAN
LET513

MR. AND MRS. WILLIAM ALEXANDER BECKFORD
ABCDEFGHIJKLMNOPQRSTUVWXYZ
ABCDEFGHIJKLMNOPQRSTUVWXYZ & 1234567890

LUBALIN GRAPH EXTRA LIGHT
LET514

Mr. and Mrs. William Alexander Beckford
ABCDEFGHIJKLMNOPQRSTUVWXYZ
abcdefghijklmnopqrstuvwxyz & 1234567890

NEW BASKERVILLE
LET516

Mr. and Mrs. William Alexander Beckford
ABCDEFGHIJKLMNOPQRSTUVWXYZ
abcdefghijklmnopqrstuvwxyz & 1234567890

OLD STYLE 7 STD ROMAN
T315

MR. AND MRS. WILLIAM ALEXANDER BECKFORD
ABCDEFGHIJKLMNOPQRSTUVWXYZ
ABCDEFGHIJKLMNOPQRSTUVWXYZ & 1234567890

OUTLINE ROMAN
LET518

MR. AND MRS. WILLIAM ALEXANDER BECKFORD
ABCDEFGHIJKLMNOPQRSTUVWXYZ
ABCDEFGHIJKLMNOPQRSTUVWXYZ & 1234567890

ROMAN SHADED D
LET519

Mr. and Mrs. William Alexander Beckford
ABCDEFGHIJKLMNOPQRSTUVWXYZ
abcdefghijklmnopqrstuvwxyz & 1234567890

SERLIO
LET520

MR. AND MRS. WILLIAM ALEXANDER BECKFORD
ABCDEFGHIJKLMNOPQRSTUVWXYZ
ABCDEFGHIJKLMNOPQRSTUVWXYZ & 1234567890

LETTERING STYLES | Serif

SHADED ROMAN
LET522

MR. AND MRS. WILLIAM ALEXANDER BECKFORD
A B C D E F G H I J K L M N O P Q R S T U V W X Y Z
A B C D E F G H I J K L M N O P Q R S T U V W X Y Z & 1 2 3 4 5 6 7 8 9 0

SOLID ANTIQUE ROMAN PRO
LET523

Mr. and Mrs. William Alexander Beckford
A B C D E F G H I J K L M N O P Q R S T U V W X Y Z
a b c d e f g h i j k l m n o p q r s t u v w x y z & 1 2 3 4 5 6 7 8 9 0

STATESMAN
LET524

Mr. and Mrs. William Alexander Beckford
A B C D E F G H I J K L M N O P Q R S T U V W X Y Z
a b c d e f g h i j k l m n o p q r s t u v w x y z & 1 2 3 4 5 6 7 8 9 0

TRAJAN
T913

MR. AND MRS. WILLIAM ALEXANDER BECKFORD
A B C D E F G H I J K L M N O P Q R S T U V W X Y Z & 1 2 3 4 5 6 7 8 9 0

LETTERING STYLES | Sans Serif

AVANT GARDE PRO BOOK
LET601

Mr. and Mrs. William Alexander Beckford
ABCDEFGHIJKLMNOPQRSTUVWXYZ
abcdefghijklmnopqrstuvwxyz & 1234567890

BANK GOTHIC LIGHT
LET604

MR. AND MRS. WILLIAM ALEXANDER BECKFORD
ABCDEFGHIJKLMNOPQRSTUVWXYZ
ABCDEFGHIJKLMNOPQRSTUVWXYZ & 1234567890

BENTON REGULAR
LET625

MR. AND MRS. WILLIAM ALEXANDER BECKFORD
ABCDEFGHIJKLMNOPQRSTUVWXYZ & 1234567890

BERNARD FASHION BT
LET605

Mr. and Mrs. William Alexander Beckford
ABCDEFGHIJKLMNOPQRSTUVWXYZ
abcdefghijklmnopqrstuvwxyz & 1234567890

EXCELSIOR GOTHIC
LET606

MR. AND MRS. WILLIAM ALEXANDER BECKFORD
ABCDEFGHIJKLMNOPQRSTUVWXYZ
ABCDEFGHIJKLMNOPQRSTUVWXYZ & 1234567890

FRUTIGER PRO 45 LIGHT
T476

MR. AND MRS. WILLIAM ALEXANDER BECKFORD
ABCDEFGHIJKLMNOPQRSTUVWXYZ & 1234567890

LETTERING STYLES | Sans Serif

FUTURA BOLD
LET607

Mr. and Mrs. William Alexander Beckford
ABCDEFGHIJKLMNOPQRSTUVWXYZ
abcdefghijklmnopqrstuvwxyz & 1234567890

FUTURA BOOK
LET609S

MR. AND MRS. WILLIAM ALEXANDER BECKFORD
ABCDEFGHIJKLMNOPQRSTUVWXYZ & 1234567890

FUTURA LIGHT
LET619

Mr. and Mrs. William Alexander Beckford
ABCDEFGHIJKLMNOPQRSTUVWXYZ
abcdefghijklmnopqrstuvwxyz & 1234567890

GILL SANS LT
T560

MR. AND MRS. WILLIAM ALEXANDER BECKFORD
ABCDEFGHIJKLMNOPQRSTUVWXYZ & 1234567890

KINGS HAT SANS TEXT
T507

MR. AND MRS. WILLIAM ALEXANDER BECKFORD
ABCDEFGHIJKLMNOPQRSTUVWXYZ & 1234567890

KINGS HAT SANS TEXT BL
T509

MR. AND MRS. WILLIAM ALEXANDER BECKFORD
ABCDEFGHIJKLMNOPQRSTUVWXYZ & 1234567890

LETTERING STYLES | Script

ANGELNA ONE
T390

Mr. and Mrs. William Alexander Beckford
A B C D E F G H I J K L M N O P Q R S T U V W X Y Z
abcdefghijklmnopqrstuvwxyz & 1234567890

BICKHAM SCRIPT
LET704

Mr. and Mrs. William Alexander Beckford
A B C D E F G H I J K L M N O P Q R S T U V W X Y Z
abcdefghijklmnopqrstuvwxyz & 1234567890

BICKHAM SWASH
LET704W

Mr. and Mrs. William Alexander Beckford
abcdefghijklmnopqrstuvwxyz & 1234567890

BURGUES SCRIPT
LET705

Mr. and Mrs. William Alexander Beckford
A B C D E F G H I J K L M N O P Q R S T U V W X Y Z
abcdefghijklmnopqrstuvwxyz & 1234567890

CITADEL SCRIPT
LET706

Mr. and Mrs. William Alexander Beckford
A B C D E F G H I J K L M N O P Q R S T U V W X Y Z
abcdefghijklmnopqrstuvwxyz & 1234567890

COLONIAL SCRIPT
LET707

Mr. and Mrs. William Alexander Beckford
A B C D E F G H I J K L M N O P Q R S T U V W X Y Z
abcdefghijklmnopqrstuvwxyz & 1234567890

FEEL SCRIPT
LET709

Mr. and Mrs. William Alexander Beckford
A B C D E F G H I J K L M N O P Q R S T U V W X Y Z
abcdefghijklmnopqrstuvwxyz & 1234567890

HARRINGTON SCRIPT
LET710

Mr. and Mrs. William Alexander Beckford
A B C D E F G H I J K L M N O P Q R S T U V W X Y Z
abcdefghijklmnopqrstuvwxyz & 1234567890

LETTERING STYLES | Script

KENSINGTON SCRIPT
LET725

Mr. and Mrs. William Alexander Beckford
A B C D E F G H I J K L M N O P Q R S T U V W X Y Z
abcdefghijklmnopqrstuvwxyz & 1234567890

LONDON SCRIPT
LET712

Mr. and Mrs. William Alexander Beckford
A B C D E F G H I J K L M N O P Q R S T U V W X Y Z
abcdefghijklmnopqrstuvwxyz & 1234567890

MOZART
LET728

Mr. and Mrs. William Alexander Beckford
A B C D E F G H I J K L M N O P Q R S T U V W X Y Z
abcdefghijklmnopqrstuvwxyz & 1234567890

PARFUMERIE SCRIPT
T540

Mr. and Mrs. William Alexander Beckford
A B C D E F G H I J K L M N O P Q R S T U V W X Y Z
abcdefghijklmnopqrstuvwxyz & 1234567890

ROOK SCRIPT
LET714

Mr. and Mrs. William Alexander Beckford
A B C D E F G H I J K L M N O P Q R S T U V W X Y Z
abcdefghijklmnopqrstuvwxyz & 1234567890

ROYAL SCRIPT
LET716

Mr. and Mrs. William Alexander Beckford
A B C D E F G H I J K L M N O P Q R S T U V W X Y Z
abcdefghijklmnopqrstuvwxyz & 1234567890

SHELLY ALLEGRO
T169

Mr. and Mrs. William Alexander Beckford
A B C D E F G H I J K L M N O P Q R S T U V W X Y Z
abcdefghijklmnopqrstuvwxyz & 1234567890

LETTERING STYLES | Italic and Semi-Script

AVALON
LET701

Mr. and Mrs. William Alexander Beckford
A B C D E F G H I J K L M N O P Q R S T U V W X Y Z
abcdefghijklmnopqrstuvwxyz & 1234567890

BAMBOL
LET723

Mr. and Mrs. William Alexander Beckford
A B C D E F G H I J K L M N O P Q R S T U V W X Y Z
abcdefghijklmnopqrstuvwxyz & 1234567890

BAUER BODONI ITALIC
LET551

Mr. and Mrs. William Alexander Beckford
A B C D E F G H I J K L M N O P Q R S T U V W X Y Z
abcdefghijklmnopqrstuvwxyz & 1234567890

BENTON ITALIC ALL CAPS
LET629C

MR. AND MRS. WILLIAM ALEXANDER BECKFORD
A B C D E F G H I J K L M N O P Q R S T U V W X Y Z
abcdefghijklmnopqrstuvwxyz & 1234567890

NEW BASKERVILLE ITALIC
ITC PRO
LET517

Mr. and Mrs. William Alexander Beckford
A B C D E F G H I J K L M N O P Q R S T U V W X Y Z
abcdefghijklmnopqrstuvwxyz & 1234567890

SNELL ROUNDHAND
LET715

Mr. and Mrs. William Alexander Beckford
A B C D E F G H I J K L M N O P Q R S T U V W X Y Z
abcdefghijklmnopqrstuvwxyz & 1234567890

STYVESANT SCRIPT SOLID
LET720

Mr. and Mrs. William Alexander Beckford
A B C D E F G H I J K L M N O P Q R S T U V W X Y Z
abcdefghijklmnopqrstuvwxyz & 1234567890

STYVESANT SCRIPT
LET721

Mr. and Mrs. William Alexander Beckford
A B C D E F G H I J K L M N O P Q R S T U V W X Y Z
abcdefghijklmnopqrstuvwxyz & 1234567890

MONOGRAMS

AVAILABLE ON PDS AND THROUGH CONCIERGE



M257



M451



MON200A



MON200B

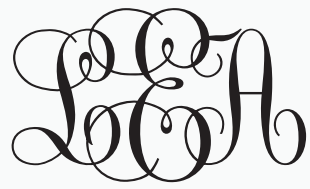

MON200C

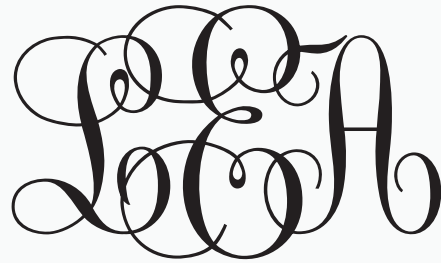

MON200D



MON202A



MON202B



MON202C



MON205A



MON205B



MON206A



MON206B



MON206C



MON206D



MON209A



MON209B



MON216A



MON216B



MON216C

W-2022

MONOGRAMS

AVAILABLE ON PDS AND THROUGH CONCIERGE



MON216D



MON216E



MON217A



MON217B



MON219A



MON222C



MON224A



MON224B



MON224C

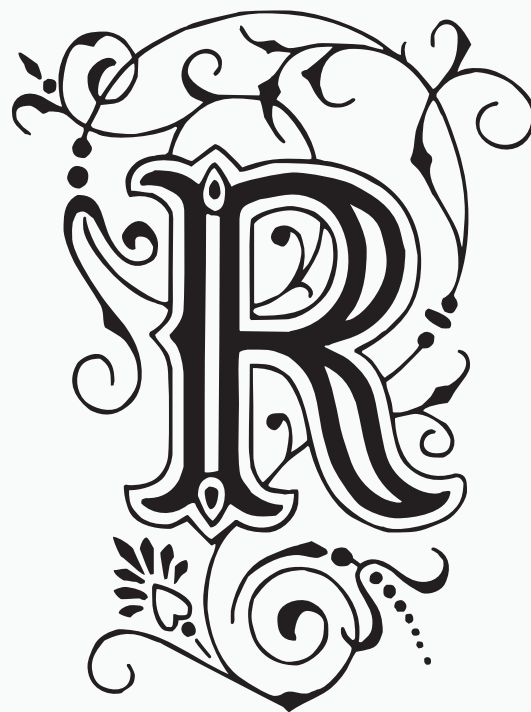

MON224D



MON231A



MON231B

MONOGRAMS

AVAILABLE ON PDS AND THROUGH CONCIERGE



MON233A
MON233C



MON233B



MON233D

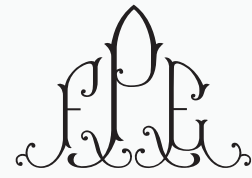

MON259A

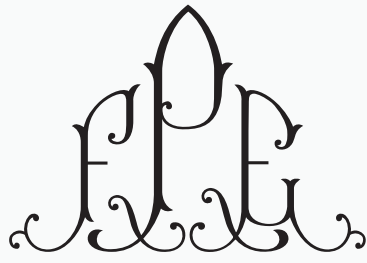

MON259B

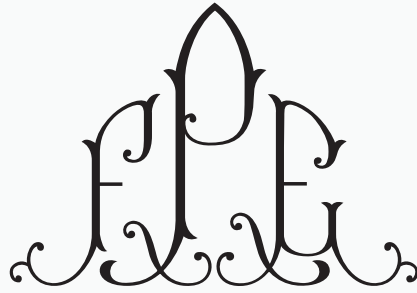

MON259C



MON266A



MON275A



MON281A



MON290A



MON293A



MON293B



MON298A



MON298B



MON299A



MON299B

W-2022

MONOGRAMS

AVAILABLE ON PDS AND THROUGH CONCIERGE

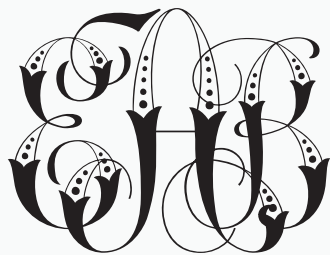

MON303A

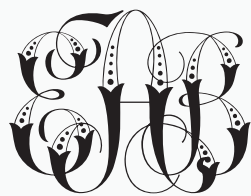

MON303B



MON307A



MON307B



MON330A



MON330B



MON330C



MON333A
MON333B



MON333C



MON334A

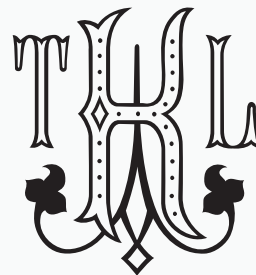

MON334B

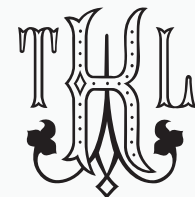

MON334C



MON343A



MON343B



MON348A



MON353A



MON362A



MON362B



MON398A

MONOGRAMS

AVAILABLE ON PDS AND THROUGH CONCIERGE



MON398B

MON402A

MON414A

MON439A



MON439B



MON439C



MON439D



MON450A



MON455A



MON455B



MON462A



MON462B



MON462C



MON465A



MON472A



MON498A

W-2022

MONOGRAMS

AVAILABLE ON PDS AND THROUGH CONCIERGE



MON505A



MON507A



MON512A



MON512B



MON529A



MON529B



MON532A



MON542A



MON552A



MON552B



MON552C



MON555A



MON556A



MON557A



MON557B



MON557C



MON559A

MONOGRAMS

AVAILABLE THROUGH CONCIERGE ONLY



J075



J123A



J123B



J192



J326A



J326B



J326C



J339



J340A



J340B



J341A



J341B



B342A



J342B



J344A



J344B



J345A



J345B



J354A



J354B

W-2022

MONOGRAMS

AVAILABLE THROUGH CONCIERGE ONLY



J373A



J373B



J390A



J390B



J390C

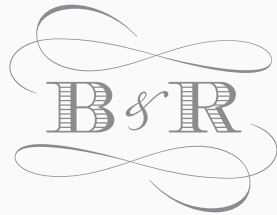

J526A



J545A



M412A



M412B



M421A



M421B



M531A



M531B



M531C



M531D

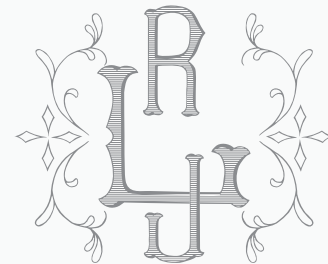

MON257A



MON257B



MON464A



MON464B



MON496A

MONOGRAMS

AVAILABLE THROUGH CONCIERGE ONLY



MON499A



MON499B



MON501A



MON506A



MON508A



MON508B



MON508C



MON509A



MON513A



MON513B



MON514A



MON514B



MON514C



MON519A



MON525A



MON525B





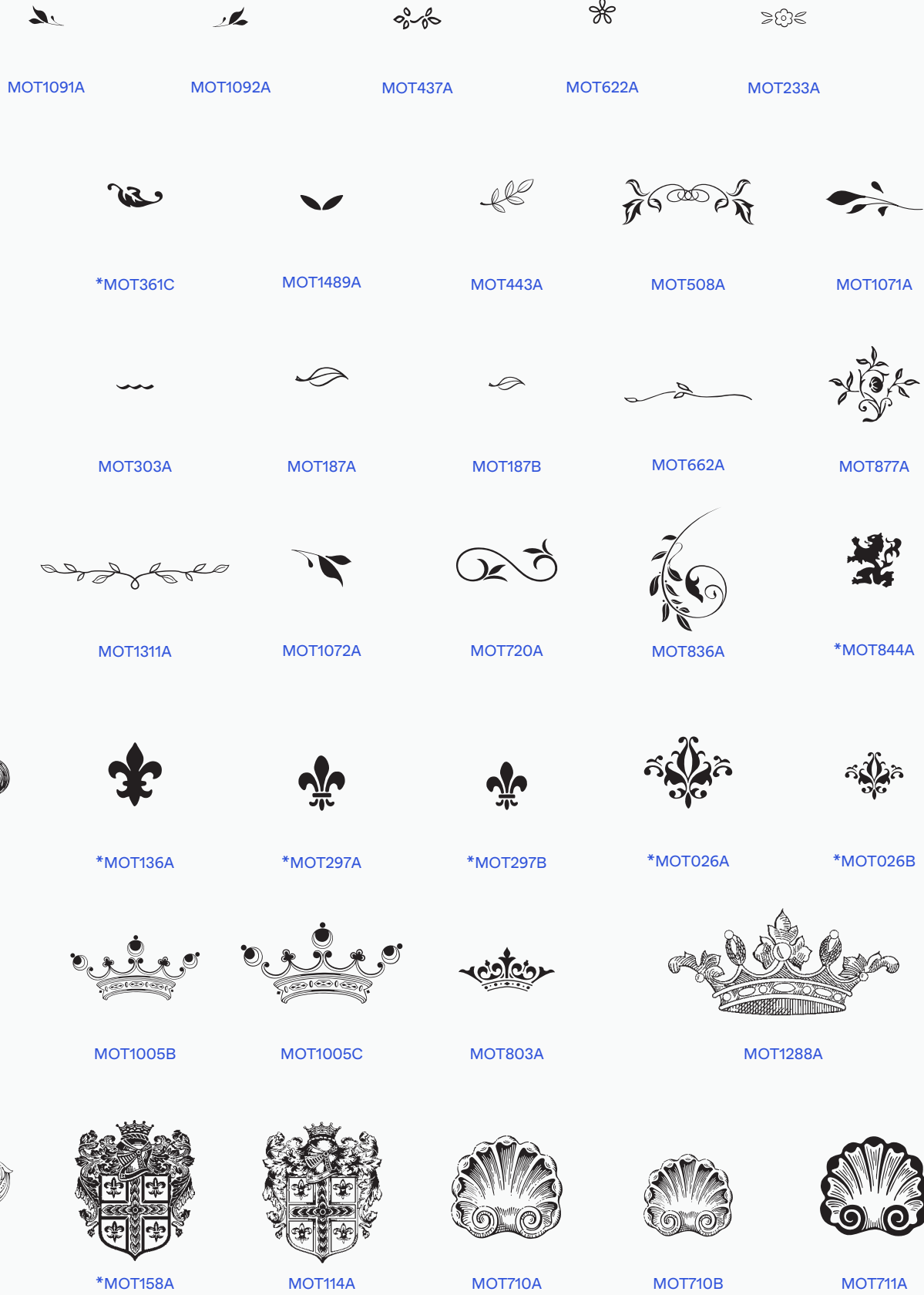









































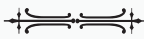

W-2022

MOTIFS | Embellishments and Graphics



W-2022

MOTIFS | Embellishments and Graphics

					
MOT615A	MOT489A	*MOT224A	*MOT787A	*MOT159A	*MOT159B
					
*MOT299A	MOT795A	MOT451A	MOT1090A	MOT1090B	*MOT159C
					
*MOT458A	*MOT458C	MOT514A	MOT446A	*MOT481A	*MOT481B
					
*MOT458B	*MOT458D	MOT514A	MOT446A	*MOT481A	MOT481C
					
*MOT281A	MOT874A	*MOT889A	*MOT163A	*MOT163B	*MOT208A
					
MOT1515A	MOT1520A	MOT1397A	MOT770A	MOT1155A	MOT1156A
					
MOT778A	MOT778B	MOT780A	MOT779A	MOT779B	MOT1413A
					
MOT1000A	MOT1000B	MOT1001A	MOT1001B	MOT1394A	*MOT298A

W-2022

* Can Be Embossed

Designs will be printed in the size shown, unless specified otherwise.



MOTIFS | Embellishments and Graphics

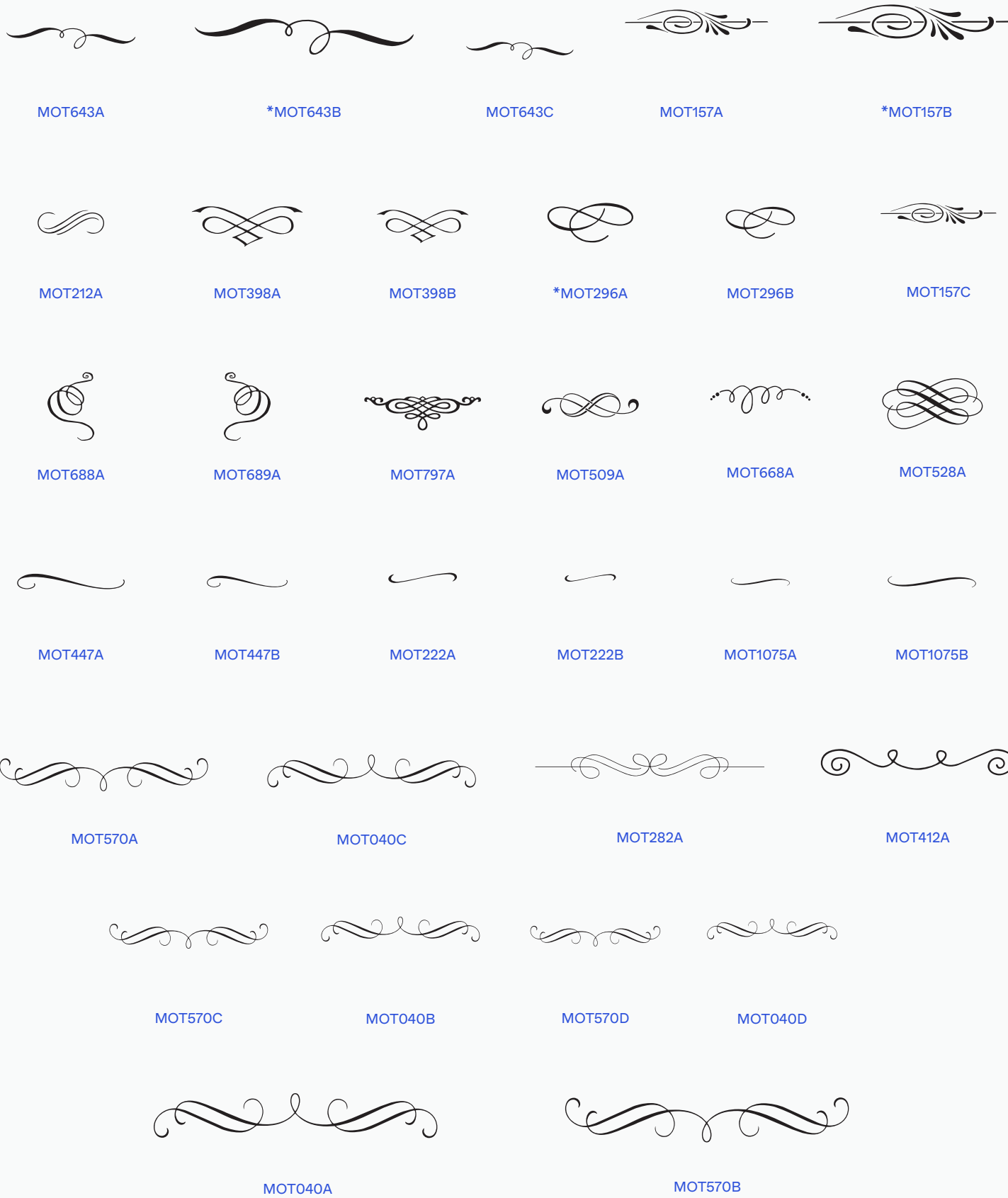

W-2022

MOTIFS | Embellishments and Graphics

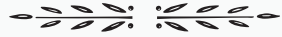

MOT161A

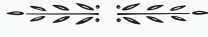

MOT161B



*MOT162A



*MOT731A



MOT789A



MOT789B



MOT788A



MOT121A



*MOT043A



*MOT043B



MOT209A



*MOT046B



MOT771A



MOT869A



*MOT046A



MOT1208A



MOT1209A



MOT1362A



MOT265A



MOT265B



MOT041A

W-2022

* Can Be Embossed

Designs will be printed in the size shown, unless specified otherwise.



MOTIFS | Embellishments and Graphics



MOT1298A



MOT1407A



MOT1299A



MOT1300A



MOT1301A



MOT1317A



MOT1318A



MOT1301B



MOT1103A

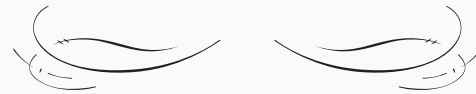

MOT1408A

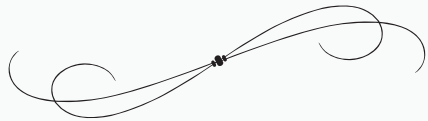

MOT1102A

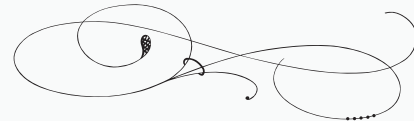

MOT1101A



MOT1404A



MOT1088A

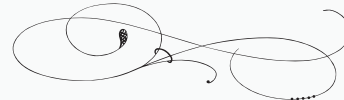

MOT1101B



MOT1404B



MOT1100A



MOT1101C



MOT1303A



MOT1409A



MOT1402A



MOT1315A

W-2022

MOTIFS | Embellishments and Graphics

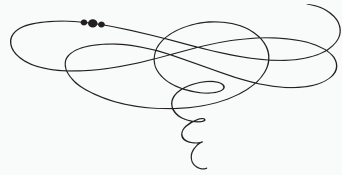

MOT1109A



MOT545A



MOT545B



MOT545C



MOT545D



MOT1182A



MOT897A



MOT898A



MOT1479A



MOT1213A



MOT1357A



MOT1472A



MOT1432A



MOT1492A



MOT1493A



MOT1116A



MOT1116B



*MOT838A



*MOT894A



MOT522A



MOT854A



*MOT211A



*MOT660B



*MOT660A



MOT1080A

W-2022

* Can Be Embossed

Designs will be printed in the size shown, unless specified otherwise.



MOTIFS | Embellishments and Graphics



*MOT1081B



MOT1085A



MOT1085B



MOT1086A



MOT1086B



MOT1081A



MOT1085D



MOT1086C



MOT1086D



*MOT269A



*MOT269B

W-2022

MOTIFS | Embellishments and Graphics



*MOT1121A



MOT1386A



*MOT1122A



MOT1387A



MOT1121B



MOT1259A



MOT1122B



MOT1154A



MOT1391A



MOT1325A

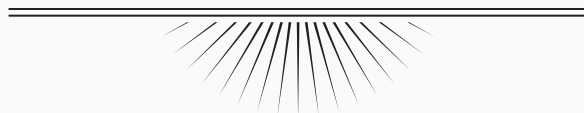

MOT1392A

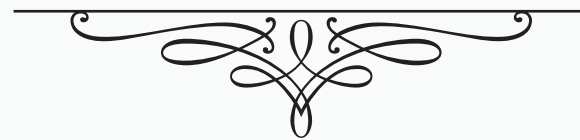

MOT1326A



MOT1325B



MOT1326B

W-2022

* Can Be Embossed

Designs will be printed in the size shown, unless specified otherwise.



MOTIFS | Embellishments and Graphics

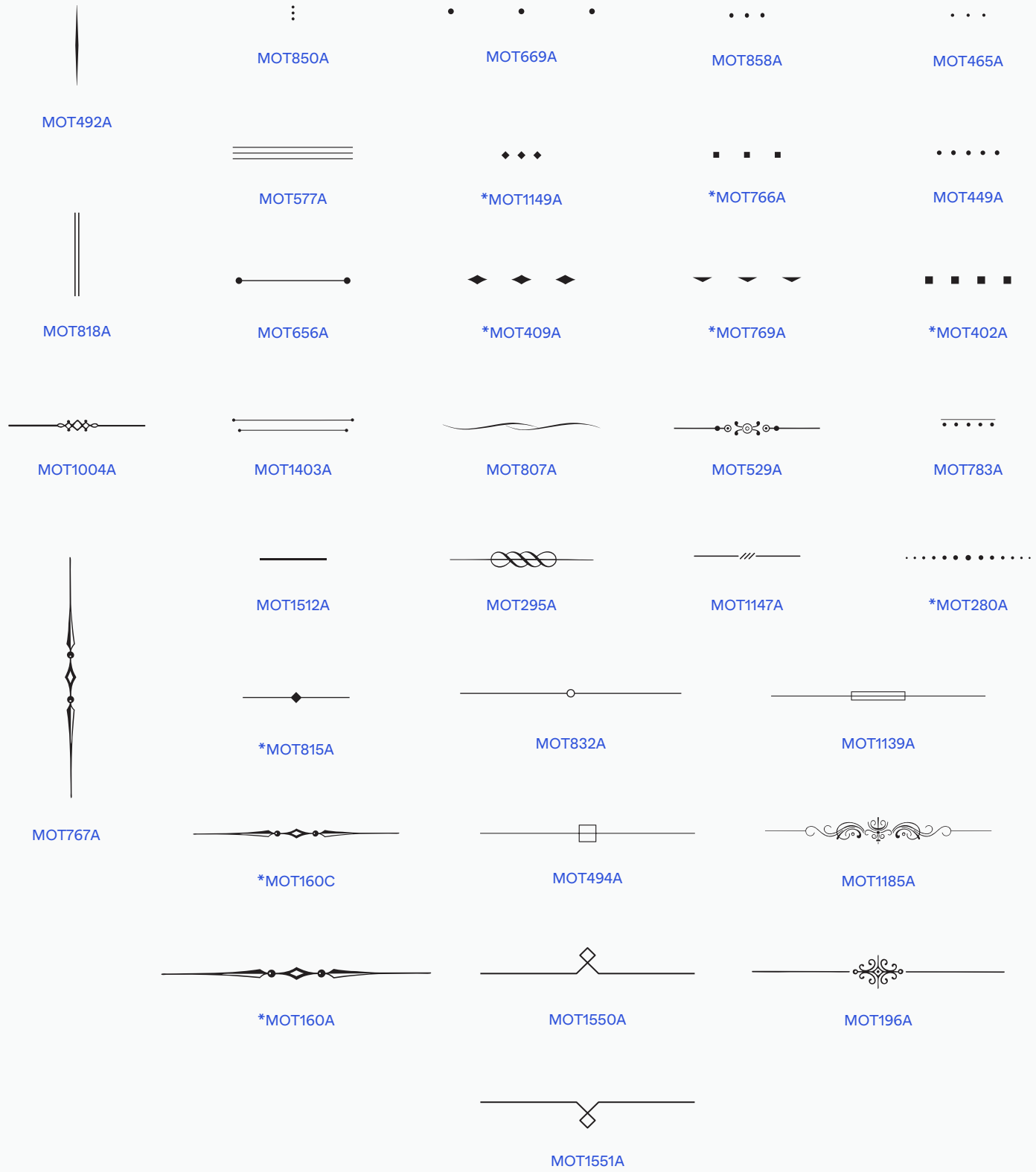

W-2022

MOTIFS | Embellishments and Graphics



MOT847A

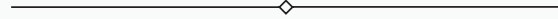

MOT1393A



MOT1118A

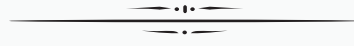

MOT1302A

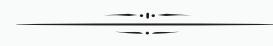

MOT1302B



MOT1335A



MOT1437A



MOT1152B

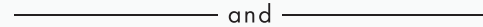

MOT1438A



MOT1439A

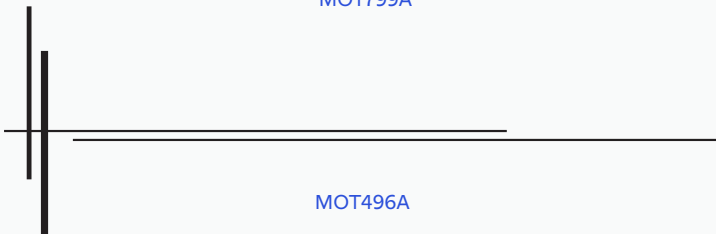

MOT799A

MOT1567A

MOT496A



MOT1564A



MOT1190A



MOT1561A



MOT1190B



MOT1561B

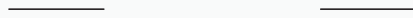

MOT1565A



MOT1562A

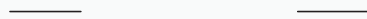

MOT1566A



MOT1560A

W-2022

* Can Be Embossed

Designs will be printed in the size shown, unless specified otherwise.



MOTIFS | Embellishments and Graphics



MOT1006A



MOT1159A

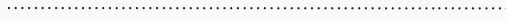

MOT813B



*MOT1220A



MOT813A



MOT603A



MOT464A



MOT604A



MOT483B



MOT798A



MOT725A



MOT482A



MOT845A



MOT1427A



*MOT469A



MOT1426A



MOT603B



MOT483A



MOT1152A

W-2022

MOTIFS | Embellishments and Graphics

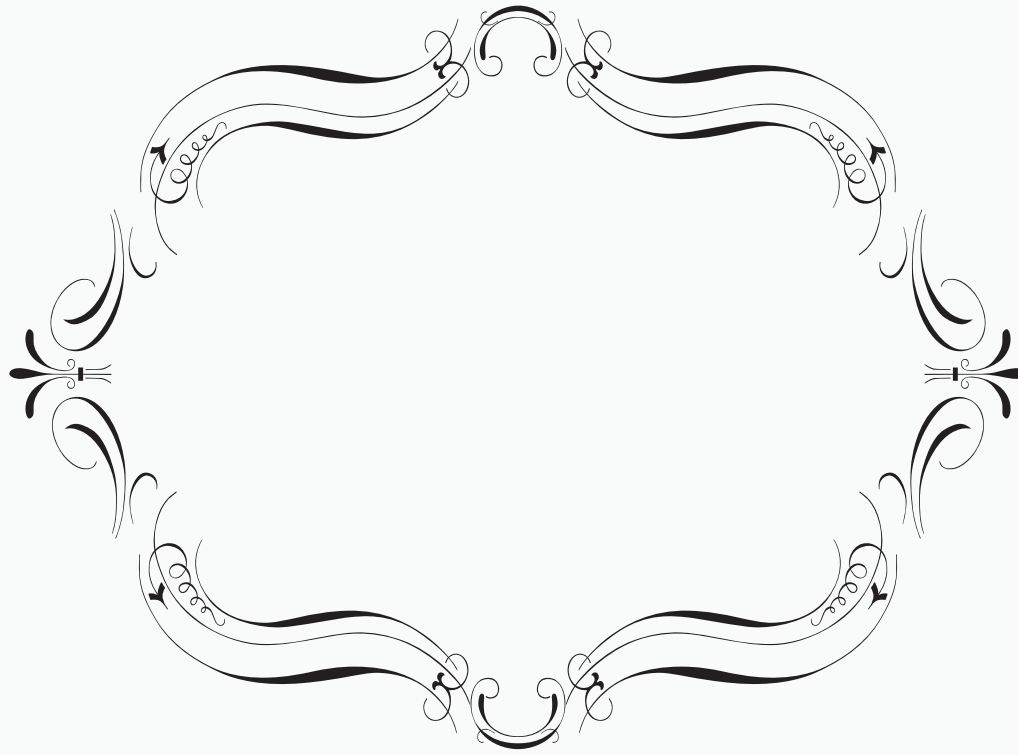

MOT1349A

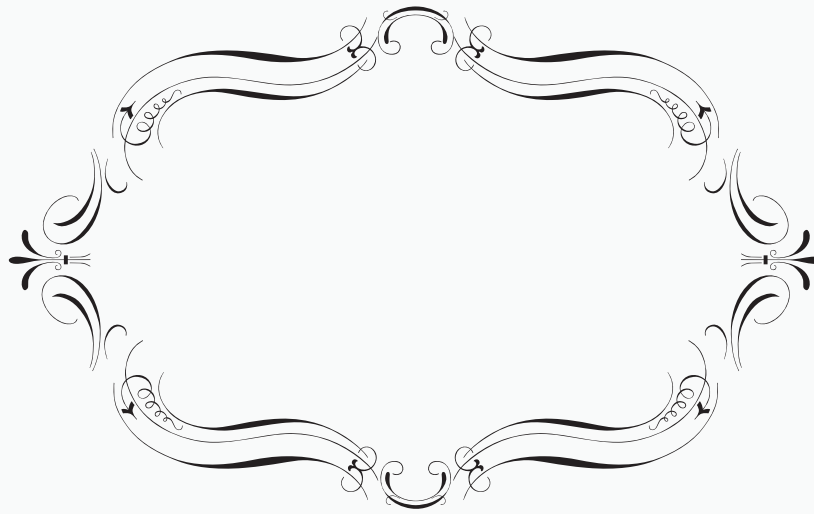

MOT1188A

W-2022

* Can Be Embossed

Designs will be printed in the size shown, unless specified otherwise.

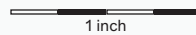

MOTIFS | Animals



MOT478A



*MOT472A



*MOT627A



*MOT871A

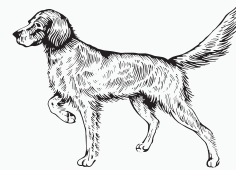

MOT071A



MOT637A



*MOT1337A



MOT1366A



*MOT143A



*MOT1371A



*MOT1370A



*MOT1368A



*MOT1367A

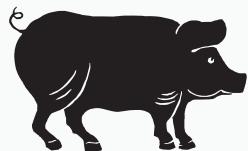

*MOT678A



*MOT334A



MOT079A

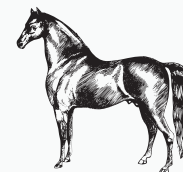

MOT016A

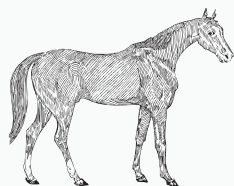

MOT576A



MOT774A



MOT527A



MOT153A

W-2022

MOTIFS | Animals



MOT137A



MOT1406A



MOT156A



MOT123A



MOT373A



MOT809A



MOT809B



MOT155A



MOT1224A



MOT1224B



MOT273A



MOT014A



MOT1369A



MOT144A



MOT146A



MOT105A



MOT148A



MOT105B

W-2022

* Can Be Embossed

Designs will be printed in the size shown, unless specified otherwise.

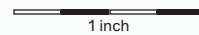

MOTIFS | Animals



MOT410A



MOT410B



MOT574A

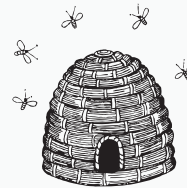

MOT679A



MOT1286A



MOT302A



MOT051A



MOT140A



MOT140B



MOT122A



MOT294A



MOT326A



MOT326B



MOT103A



MOT587A



MOT1287B

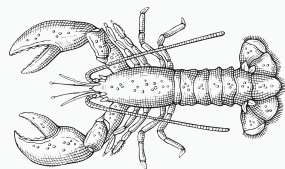

MOT118A

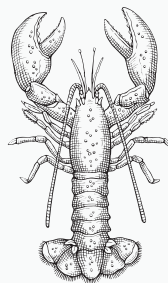

MOT1249A

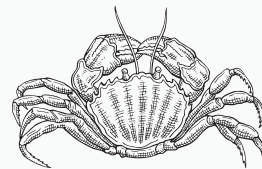

MOT117A



MOT066A

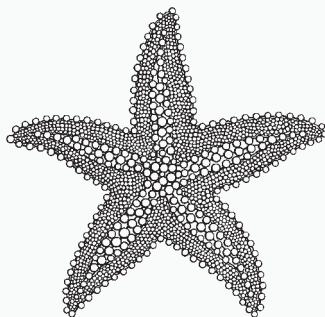

MOT1287A

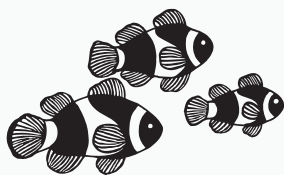

MOT751A



MOT301A



MOT562A

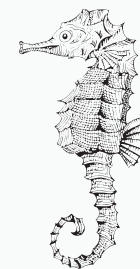

MOT064A

W-2022

MOTIFS | Animals



MOT099A

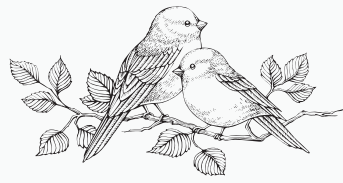

MOT099B



MOT099C



MOT1227A



*MOT819A



*MOT484A



MOT430A



MOT429A



*MOT859A



*MOT829A



MOT062A



*MOT781



MOT1014A

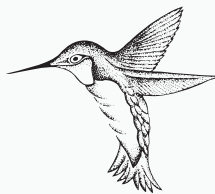

MOT504A

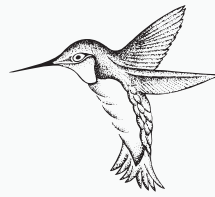

MOT408A



MOT015A

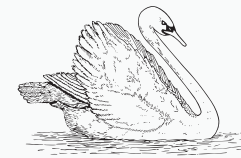

MOT091A



MOT1145A



MOT050A



MOT054A



MOT073A

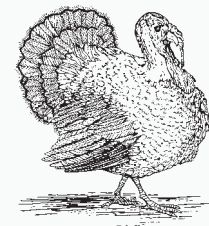

MOT083A

W-2022

* Can Be Embossed

Designs will be printed in the size shown, unless specified otherwise.



MOTIFS | Baby and Children



MOT424A



MOT424B



MOT246A



MOT237A



MOT625A



MOT427A



MOT434A



MOT1025A



MOT1027A



MOT621A



MOT619A



MOT620A



MOT393A



MOT154A



MOT252A



MOT366A



MOT602A



MOT1026A

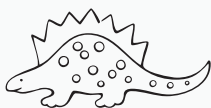

MOT244A



MOT239A



MOT601A

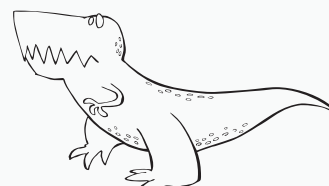

MOT370A

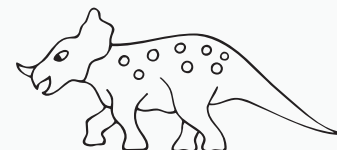

MOT248A



MOT599A



MOT250A



MOT365A



MOT243A



MOT616A



MOT322A



MOT238A



MOT888A

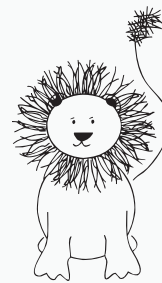

MOT613A

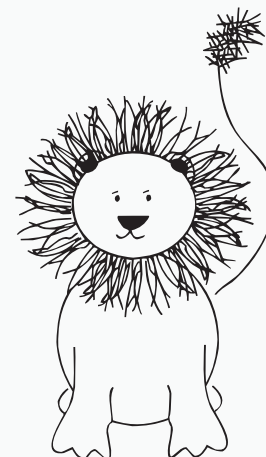

MOT613B

MOTIFS | Baby and Children



MOT1375A



MOT555A



MOT419A



MOT321A



MOT426A



MOT233A



*MOT163B



*MOT163A



MOT630A



MOT166A



*MOT618A



MOT179A



MOT179B



MOT175A



*MOT422A



MOT241A



MOT423A



MOT216A



MOT435A



MOT186A



MOT234A



MOT436A



MOT323A



MOT709A



MOT632A



MOT171A



MOT808A



MOT617A



MOT221A

W-2022

* Can Be Embossed

Designs will be printed in the size shown, unless specified otherwise.



MOTIFS | Baby and Children



MOT1231A



MOT256A



MOT258A

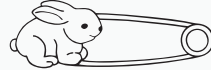

MOT257A



*MOT255A



MOT607A



MOT607B

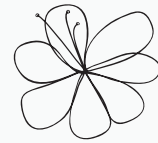

MOT501A

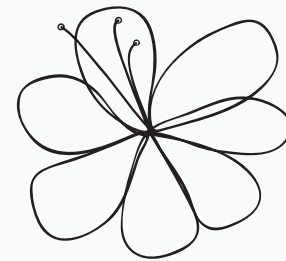

MOT501B



MOT188A



*MOT236A



MOT420A



MOT712A

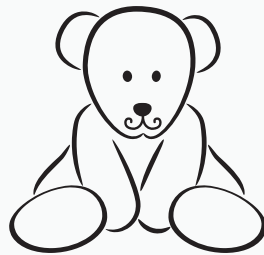

MOT1376A

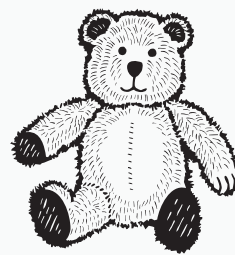

MOT598A

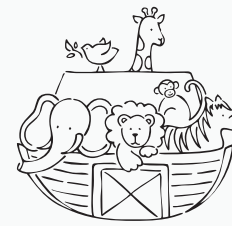

MOT232A

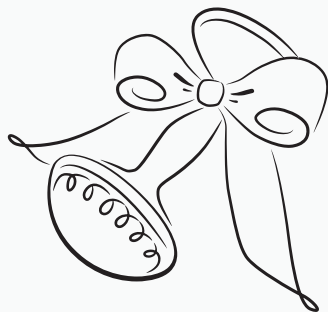

MOT1373A



MOT1374A



MOT1377A



MOT629A

W-2022

MOTIFS | Graduation



*MOT544A



MOT1557A



MOT544C



MOT1556A



MOT207A



MOT195A



*MOT158A



MOT100A



*MOT225A



*MOT288B



*MOT1559A



*MOT290C



MOT541A

adventure awaits

MOT1555A



MOT1479A



MOT1325B



MOT545D



MOT1326B

W-2022

* Can Be Embossed

Designs will be printed in the size shown, unless specified otherwise.

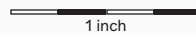

MOTIFS | Business



MOT438A



MOT1219A



MOT285A



MOT284A



MOT289A



MOT289B



*MOT290A



*MOT290B



*MOT288A



MOT287A



MOT831A



MOT831B



MOT856A



MOT849A



MOT278A



MOT278B



MOT150A



MOT150B



MOT532A

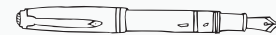

MOT532B



MOT276A



MOT276B



*MOT275A



MOT851A

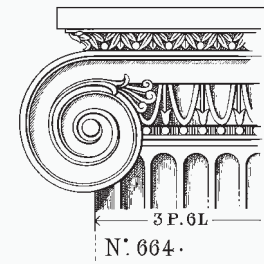

MOT1338A

MOTIFS | Patriotic and Military



MOT317A
ARMY



MOT320A
AIR FORCE



MOT318A
NAVY



MOT319A
MARINE



MOT341A

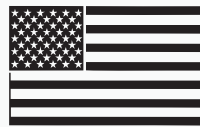

*MOT339A

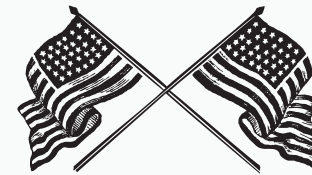

MOT348A



MOT1553A



MOT346A

W-2022

* Can Be Embossed

Designs will be printed in the size shown, unless specified otherwise.



MOTIFS | Spiritual and Sympathy



*MOT135A



*MOT135B



*MOT135C



*MOT405A



MOT1094B



*MOT314A



*MOT864A

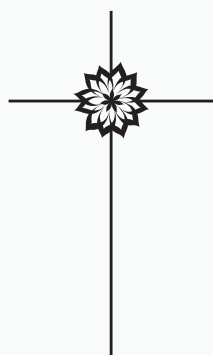

MOT600A



MOT863A



MOT868A

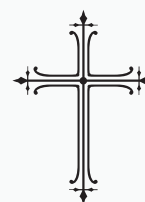

MOT1094A



MOT315A

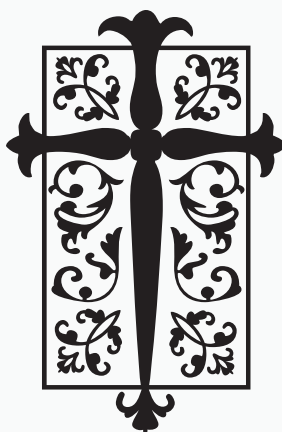

*MOT864B



*MOT413A



MOT311A



MOT865A



MOT466A



MOT1056A



MOT475A



*MOT134A



*MOT134B

ב"ה

*MOT1123A
BAYS HAY

לחיים

*MOT1128A
L'CHAIM

מזל טוב

*MOT1127A
MAZEL TOV

בס"ד

*MOT1124A
BAYS SAMEKH
DALED

בר מצוה

*MOT1125A
BAR MITZVAH

בת מצוה

*MOT1126A
BAT MITZVAH

MOTIFS | Spiritual and Sympathy



MOT254A



MOT749A



MOT749B



MOT309A



MOT313B



MOT313A



MOT310A



MOT312A



MOT017B

W-2022

* Can Be Embossed

Designs will be printed in the size shown, unless specified otherwise.



MOTIFS | Home and Moving



MOT034A



MOT034B



MOT169A



MOT203A

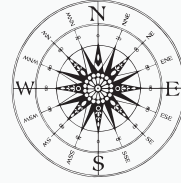

MOT277A



MOT277B



*MOT848A



*MOT291A



*MOT291B

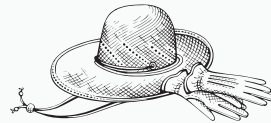

MOT147A



MOT406A



MOT406B



MOT1063A



MOT355A

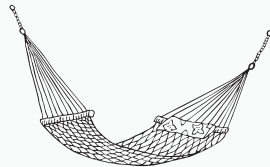

MOT384A

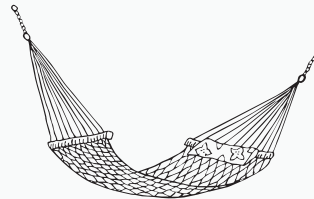

MOT384B



MOT480A



*MOT210A



*MOT210B



MOT541A



MOT383A



MOT653A

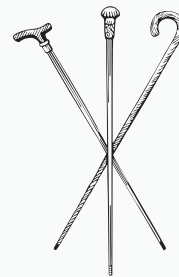

MOT082A



MOT665A

W-2022

MOTIFS | Sporting



MOT057A



MOT142A



MOT141A



MOT088A



MOT571A



*MOT1363A



*MOT293A



MOT086A



MOT086B



MOT084A



MOT084B



MOT084C



MOT358A



MOT358B



MOT1070A



*MOT747A



*MOT747B

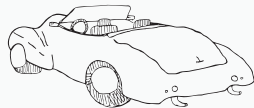

MOT333A

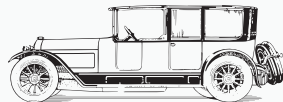

MOT113A



MOT138A



MOT138B



*MOT560A



MOT292A

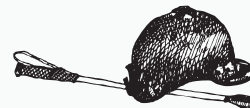

MOT804A

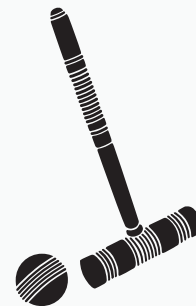

MOT1365A



MOT1364A

W-2022

* Can Be Embossed

Designs will be printed in the size shown, unless specified otherwise.



MOTIFS | Seaside and Nautical



MOT033A



MOT033B



MOT1333A



MOT1333B



MOT444A

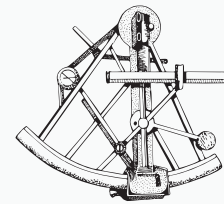

MOT065A



*MOT1380A

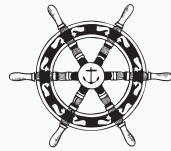

MOT068B



*MOT614A



MOT691A



MOT1045A



MOT1046A



*MOT455A



*MOT1047A

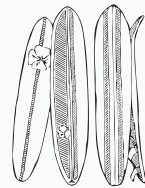

MOT811A



MOT072A



MOT471A

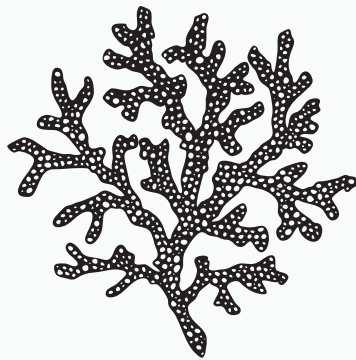

MOT746A



MOT746B



MOT746C

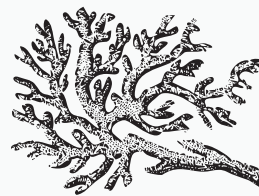

MOT883A



MOT883B



MOT1030A



MOT387A

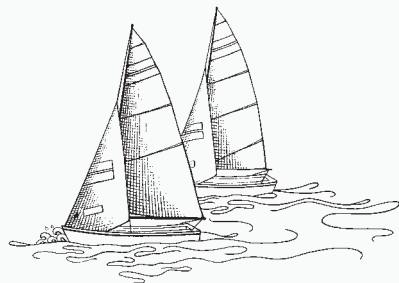

MOT1382A



MOT1389A



MOT1381A



MOT518A

W-2022

MOTIFS | Seaside and Nautical

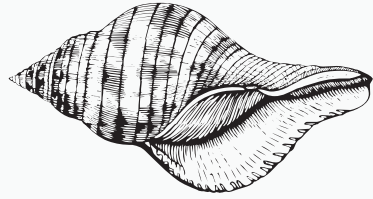

MOT1430A
*MOT1424A BLIND EMBOSS ONLY



MOT063A



*MOT116A

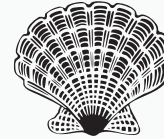

*MOT116B



MOT031A



MOT462A



MOT462B



MOT1044A



MOT453A



MOT453B



MOT1015A

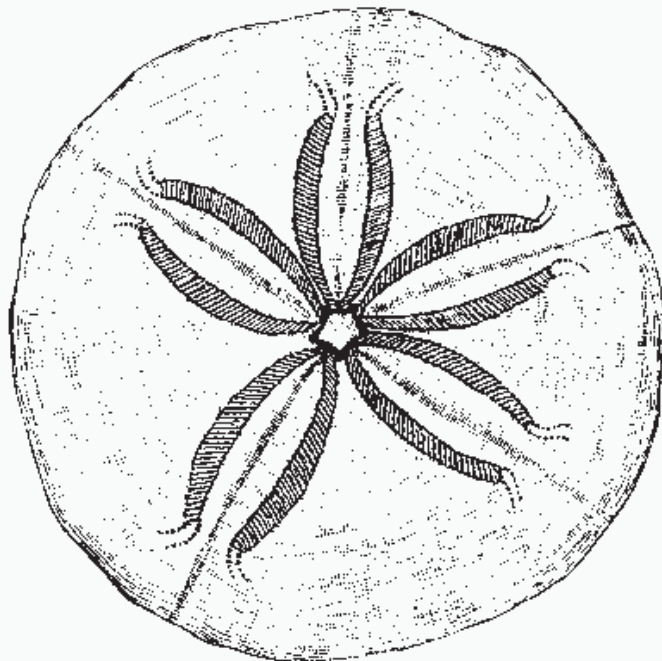

MOT1359A
*MOT1328A BLIND EMBOSS ONLY

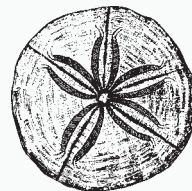

MOT1359D



MOT457A



MOT457B



*MOT047A

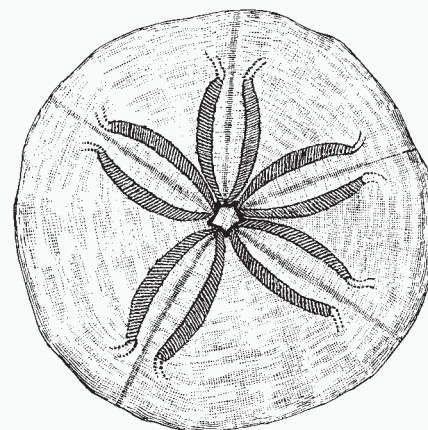

MOT1359C

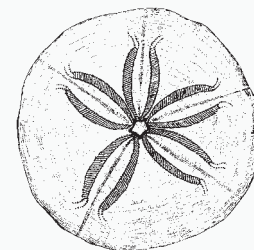

MOT1359B
*MOT1328B BLIND EMBOSS ONLY

W-2022

* Can Be Embossed

Designs will be printed in the size shown, unless specified otherwise.



MOTIFS | Destination and Travel



MOT762A



MOT067A

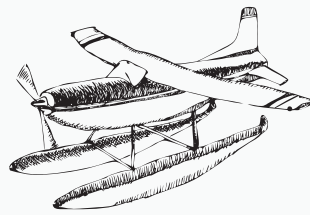

MOT739A



MOT531A



MOT738A

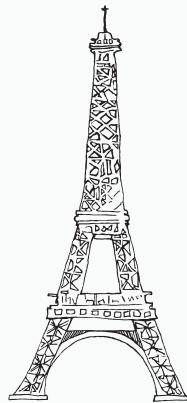

MOT763A

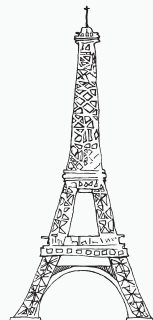

MOT763B

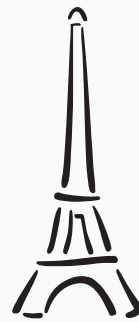

*MOT463A



MOT737A



*MOT470A

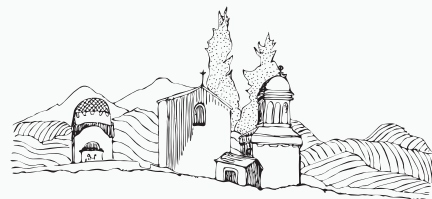

MOT753A



MOT806A



MOT1089A

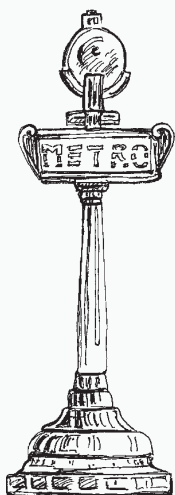

MOT1378A



MOT742A

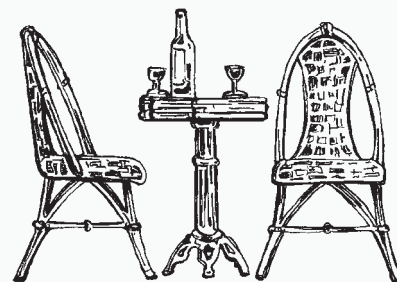

MOT1379A

W-2022

MOTIFS | Entertaining and Music



MOT200A



MOT306A



MOT536A



MOT1232A



MOT551A



MOT038A



*MOT164A



MOT683A



MOT1067A



MOT174A



MOT108A



MOT512A



MOT516A



MOT414A



MOT189A



MOT1069A



MOT1068A



MOT380A



MOT516B



MOT1061A



MOT1061B



MOT1062A

W-2022

* Can Be Embossed

Designs will be printed in the size shown, unless specified otherwise.

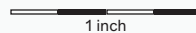

MOTIFS | Entertaining and Music



MOT661A



*MOT226A



MOT218A



MOT1057A



MOT1051A



MOT1051B



MOT1052A



MOT1052B



MOT1053A



MOT1053B



MOT1054A



MOT1054B



MOT223A



MOT1055A



MOT624A

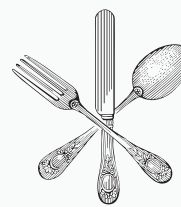

MOT097A



MOT1545A



MOT354A



MOT520A



*MOT519A



MOT027A

W-2022

MOTIFS | Words and Symbols

W-2022

————— BY —————
MOT1307A

————— AND —————
MOT1306A

————— TO —————
MOT1348A

————— TO —————
MOT1342A

————— BY —————
MOT1331A

————— *by* —————
MOT1305A

————— AND —————
MOT1332A

————— *the* —————
MOT1347A

..... TO

MOT1312A

————— *and* —————
MOT1304A

..... AND

MOT1345A

————— *to* —————
MOT1346A

————— TO —————
MOT1340A

————— BY —————
MOT1324A

————— AND —————
MOT1323A

————— THE —————
MOT1343A

————— OF —————
MOT1341A

————— THE —————
MOT1339A

* Can Be Embossed

Designs will be printed in the size shown, unless specified otherwise.



MOTIFS | Words and Symbols



MOT1191A

SAVE THE DATE

MOT1189A

YOU'RE INVITED TO A

MOT1261A

SAVE THE DATE

MOT1351A

TOGETHER WITH THEIR FAMILIES

MOT1266A

TOGETHER WITH THEIR PARENTS

MOT1265A

KINDLY DELIVER TO:

MOT1264A

KINDLY RESPOND

MOT1262A

KINDLY REPLY BY

MOT1314A

CELEBRATE WITH US

MOT1358A

TOGETHER WITH THEIR FAMILIES

MOT1295A

TO HAVE AND TO HOLD

MOT1313A

THE FAVOUR OF YOUR RESPONSE

MOT1296A

PLEASE MARK YOUR CALENDAR

MOT1353A

PLEASE JOIN US

MOT1336A

DINNER AND DANCING TO FOLLOW

MOT1354A



MOT1173A



MOT1114A



MOT1322A



MOT1344A



MOT1361A



MOT1297A



MOT1079A



MOT1321A



MOT1316A



MOT1308A



MOT1334A



MOT1352A

W-2022

MOTIFS | Words and Symbols



MOT1212A



MOT460A



MOT517A



MOT1199A



MOT1252A



MOT1120A



MOT1241A



MOT1104A



MOT1107A



MOT1245A



MOT1132A



MOT1251A



MOT1243A



MOT1246A



MOT1242A



MOT1240A

W-2022

* Can Be Embossed

Designs will be printed in the size shown, unless specified otherwise.

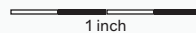

MOTIFS | Words and Symbols

Celebrate with Us

MOT1244A

Please respond

MOT1133A

Celebration

MOT1135A

Reception

MOT1134A

Celebrate

MOT1105A

Save the Date

MOT1108A

Please Reply

MOT1113A

répondez, sil vous plaît

MOT1112A

No

MOT1111A

RSVP

*MOT1327A

CELEBRATE

*MOT1355A

SAVE
THE
DATE

*MOT1356A

RSVP |

*MOT1309A

RSVP

*MOT1310A

W-2022

MOTIFS | Words and Symbols

Salad

MOT1525A

Entrées

MOT1526A

Dessert

MOT1527A

Details

MOT1477A

Menu

MOT1110A

bon appétit

MOT1115A

Celebrate

MOT1105A

Table _____

MOT1468A

Table _____

MOT1528A

Table _____

MOT1486A

*You Are
Invited*

MOT1009A

Cheers!

MOT1032A

25th Anniversary

MOT673A

Celebrate!

MOT1020A

50th Anniversary

MOT674A

W-2022

* Can Be Embossed

Designs will be printed in the size shown, unless specified otherwise.

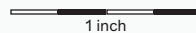

1 inch

MOTIFS | Words and Symbols



*MOT1414A



MOT1399A



MOT1469A



*MOT1425A



MOT1517A



*MOT1523A



MOT1390A



MOT1440A

*MOT1429A BLIND EMBOSS ONLY



MOT1400A



MOT1428A

W-2022

TO
Have
AND TO
Hold

TO
Love
AND TO
Cherish

MOT1329A

MOT1330A

SAVE
THE
DATE

FROM
This Day
FORWARD

*MOT1360A

MOT1350A

* Can Be Embossed

Designs will be printed in the size shown, unless specified otherwise.



MOTIFS | Words and Symbols

ACCEPTS
WITH PLEASURE
N^o. _____

MOT1510A

DECLINES
WITH REGRET
N^o. _____

R S V P

MOT1513A

◇ *accepts* ◇ *regrets*

MOT1514A

to

MOT1470A

and

MOT1471A

to

MOT1482A

and

MOT1483A

SAVE *the* DATE

MOT1491A

R.S.V.P.

MOT1478A

Kindly Reply

MOT1485A

The favour of a reply is requested

MOT1516A

Reception to follow

MOT1521A

Kindly Respond

MOT1474A

Reception to follow

MOT1509A

Reception

MOT1484A

Response

MOT1467A

Reception to Follow

MOT1473A

The favour of a reply is requested

MOT1481A

*Save
the Date*

MOT1529A

Reception immediately following the ceremony

MOT1518A

W-2022

MOTIFS | Holiday



MOT1444A



MOT641A



MOT641B



MOT1013A



MOT1417A



*MOT1524A



MOT1010A



MOT735A



MOT1013B



MOT1446A



MOT259B



MOT259C



MOT1455A



MOT533A



MOT1458A



MOT1031A



MOT1018A



*MOT716A



MOT870B



MOT873B



MOT1416A

W-2022

* Can Be Embossed

Designs will be printed in the size shown, unless specified otherwise.

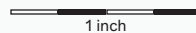

MOTIFS | Holiday



MOT1449A



MOT760A



MOT1419A



MOT1420A



MOT270A



MOT260A



MOT1043A



MOT1456A



MOT1441A



MOT379A



MOT379B



MOT754A



MOT1445A



MOT1443A



MOT1448A



MOT1451A



MOT1421A



MOT1457A



MOT1459A



MOT1460A



MOT1418A



MOT1503A



MOT548A



MOT1415A



MOT1507A



MOT1423A



MOT1034A



MOT1422A



*MOT1504A



MOT1453A



MOT547A



*MOT1508A



MOT1447A



MOT1452A



MOT1450A

W-2022

MOTIFS | Holiday



*MOT1505A



MOT549A



MOT1442A



MOT1454A

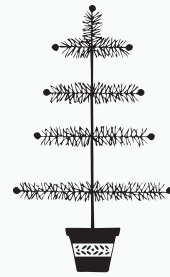

MOT378A



MOT1506A

NOEL

*MOT542A

HOPE *Peace* JOY

MOT1294A



MOT1011A

W-2022

* Can Be Embossed

Designs will be printed in the size shown, unless specified otherwise.



FRAMES

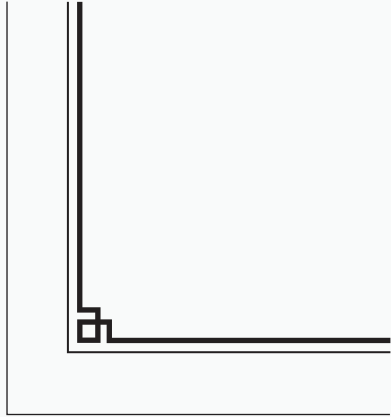

Δ*FRA002

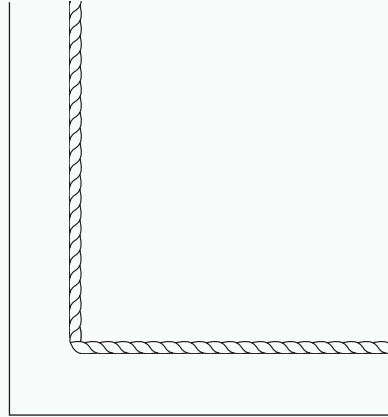

FRA005

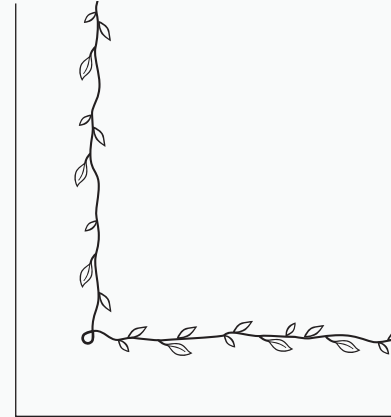

Δ FRA006

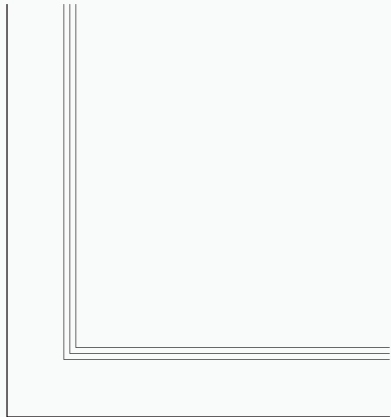

FRA010

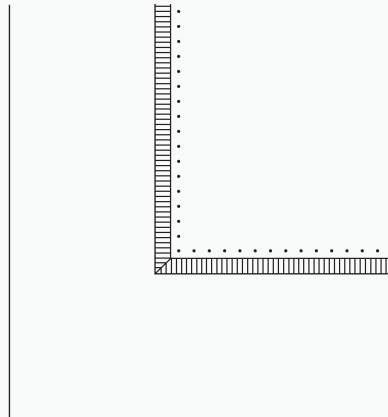

Δ FRA011

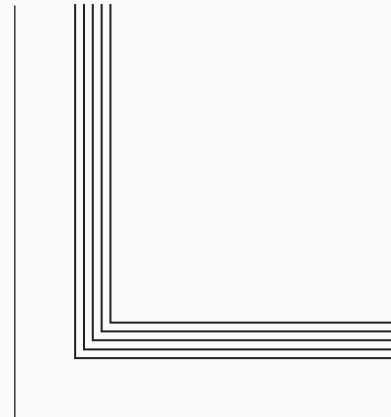

Δ FRA012

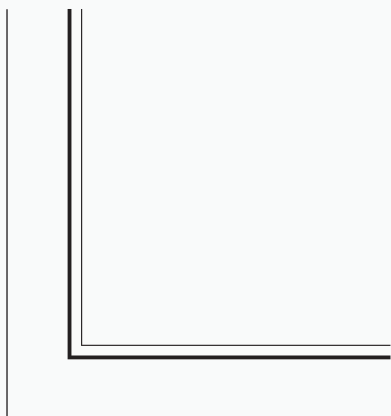

FRA022

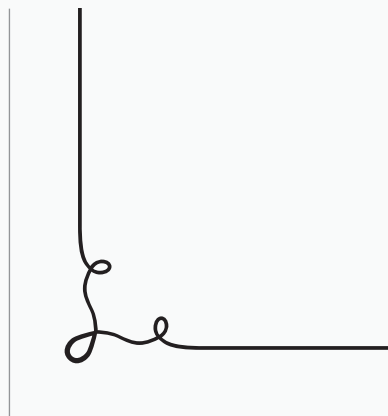

Δ*FRA024

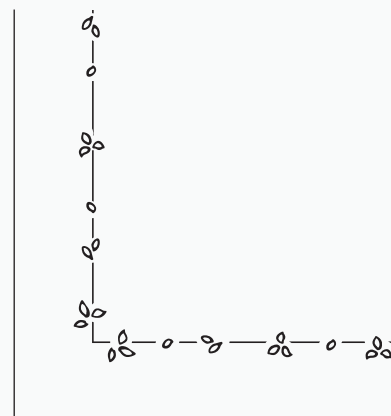

FRA042

W-2022

* Can Be Embossed
 Δ Not available
 in 124 size.

Frames are not available on most round corner or die cut cards
 unless displayed in albums.

Designs will be printed in the size shown, unless specified otherwise.

FRAMES

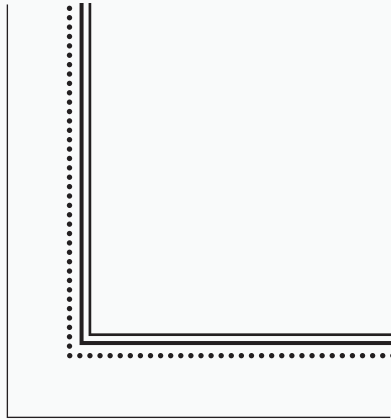

△ FRA013

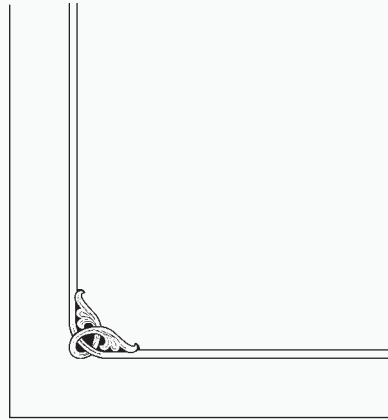

△ FRA007

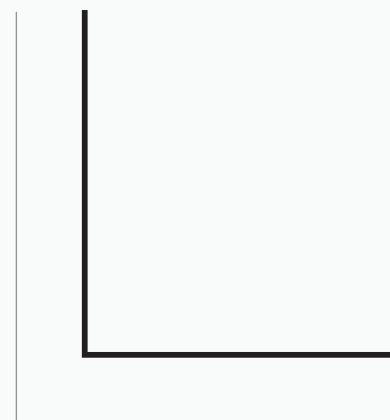

* FRA026

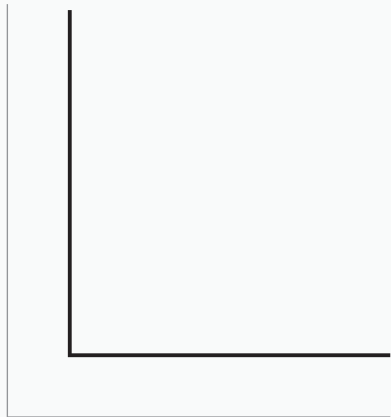

FRA023

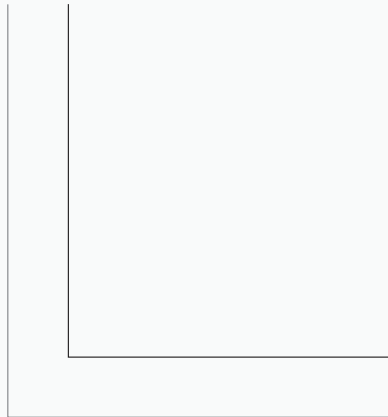

FRA028

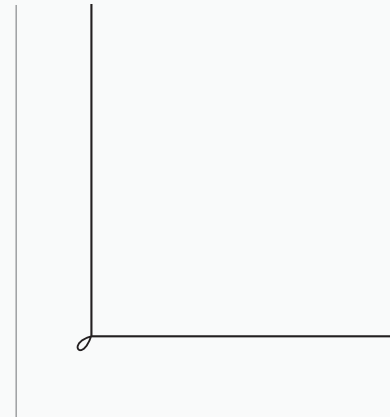

FRA025

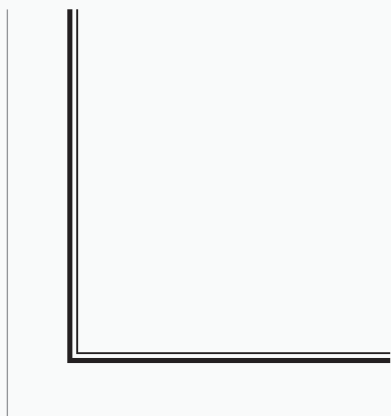

FRA027

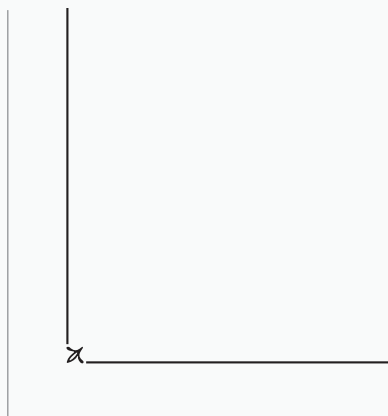

FRA030

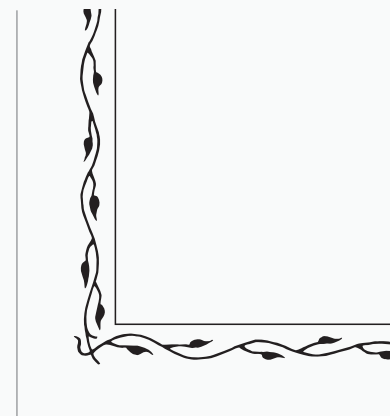

FRA031

W-2022

* Can Be Embossed
 △ Not available
 in 124 size.

Frames are not available on most round corner or die cut cards
 unless displayed in albums.

Designs will be printed in the size shown, unless specified otherwise.



FRAMES

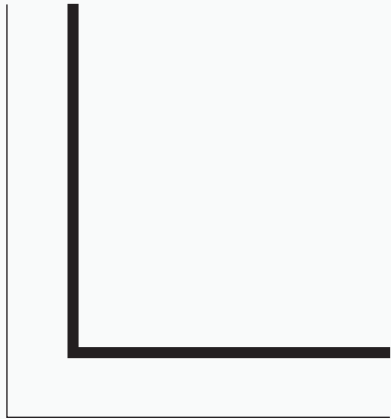

* FRA034

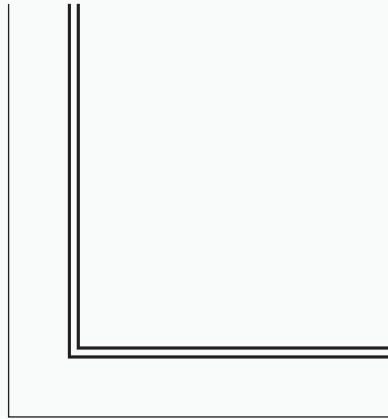

FRA035

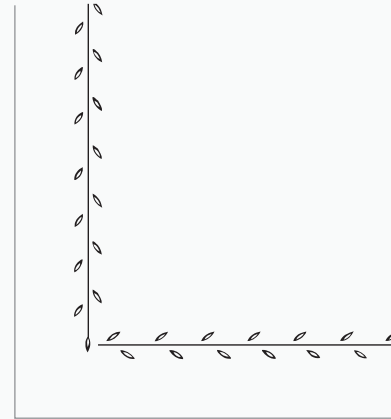

FRA036



FRA029

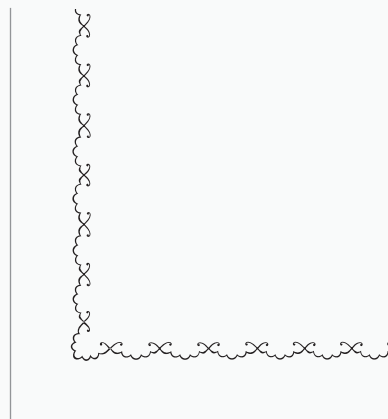

FRA043

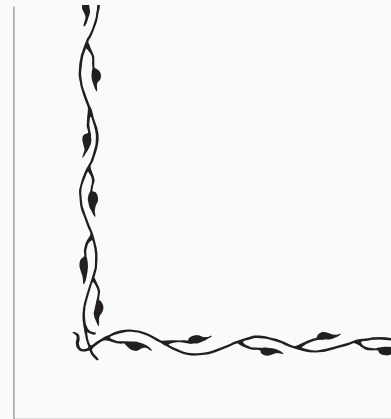

FRA037

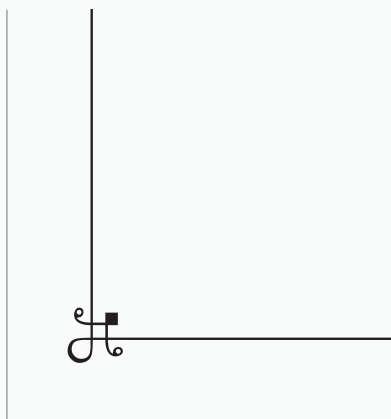

Δ FRA032

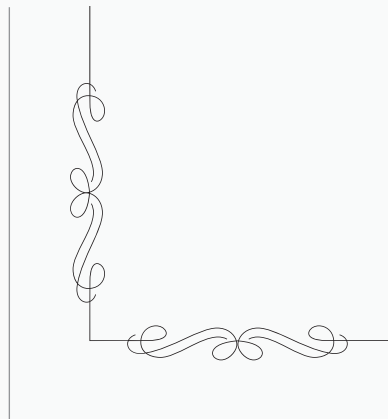

FRA038

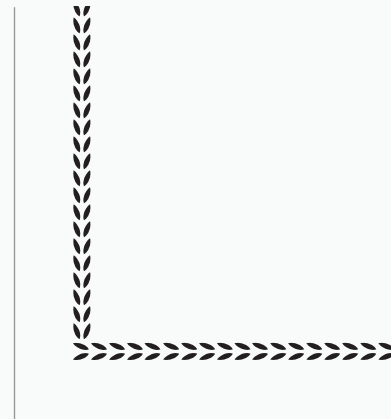

Δ FRA033

* Can Be Embossed
 Δ Not available
 in 124 size.

Frames are not available on most round corner or die cut cards
 unless displayed in albums.

Designs will be printed in the size shown, unless specified otherwise.

FRAMES



FRA039

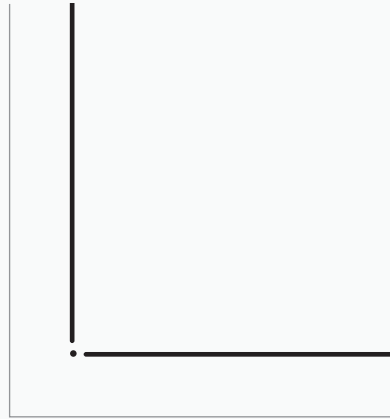

FRA040

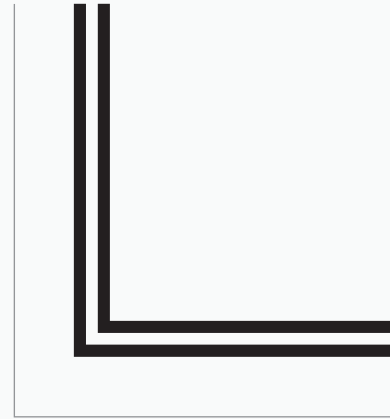

*FRA041

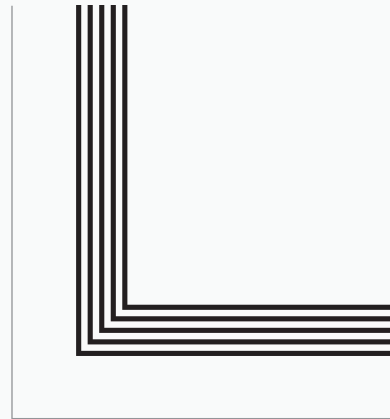

Δ*FRA1236

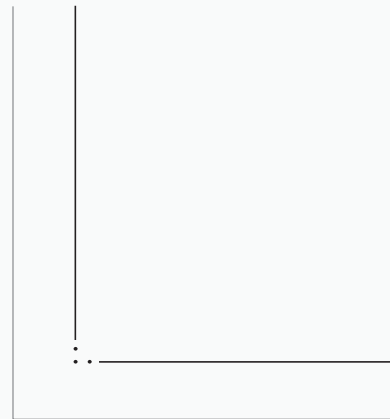

FRA1238

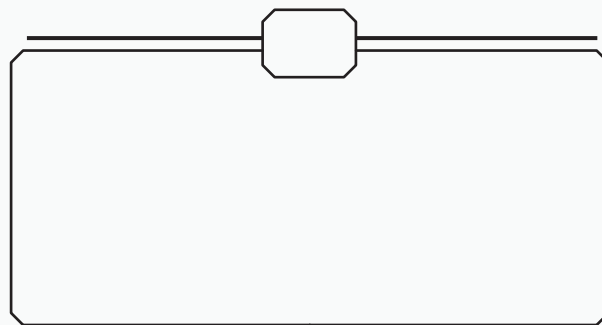

FRA1237

W-2022

* Can Be Embossed
Δ Not available
in 124 size.

Frames are not available on most round corner or die cut cards
unless displayed in albums.

Designs will be printed in the size shown, unless specified otherwise.



FRAMES

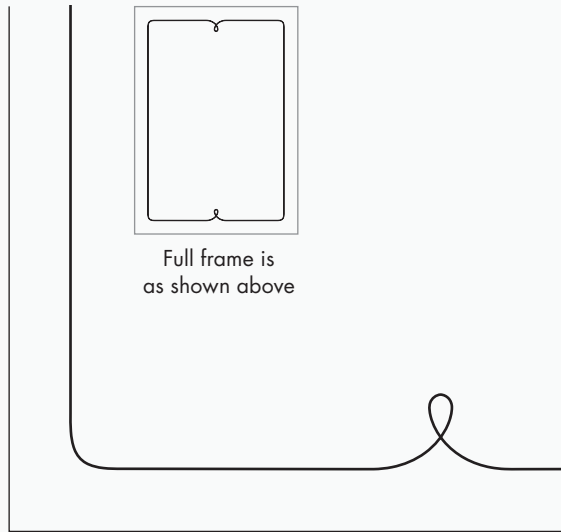

△ FRA014

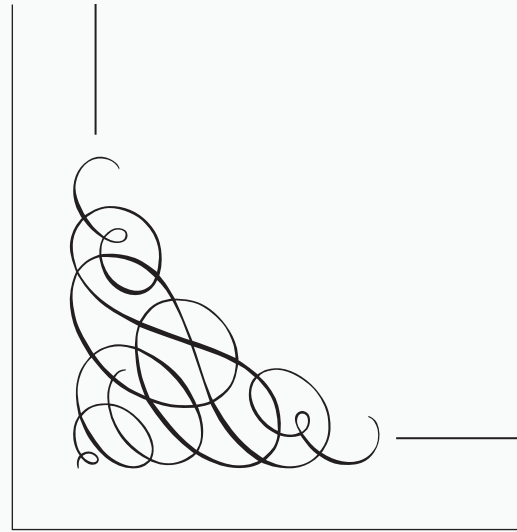

△ FRA018

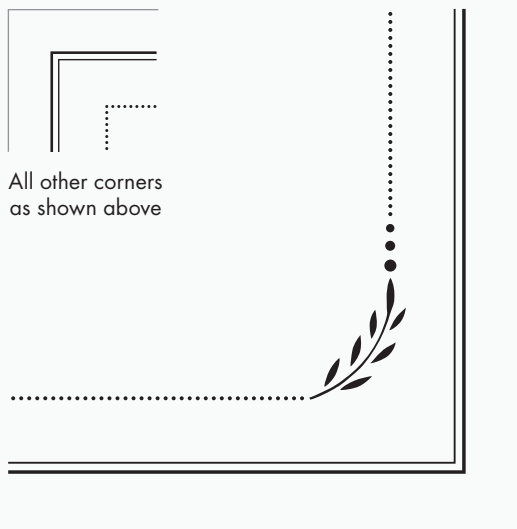

△ FRA015

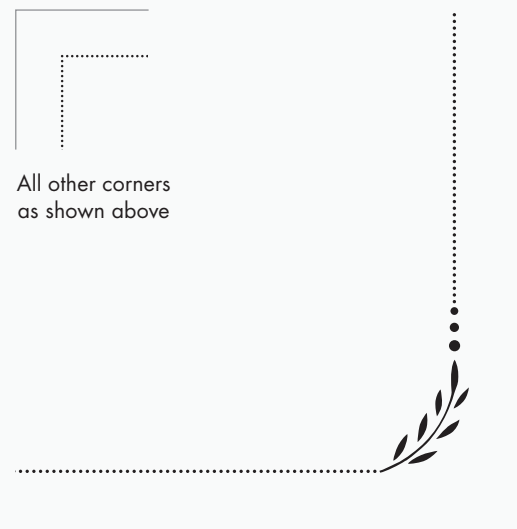

△ FRA021

* Can Be Embossed
 △ Not available in 124 size.

MOTIFS | Jotters

W-2022

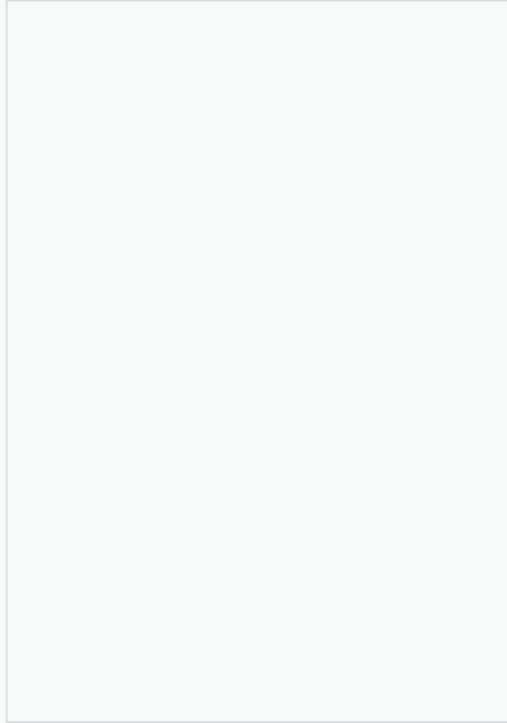

MOT1405A

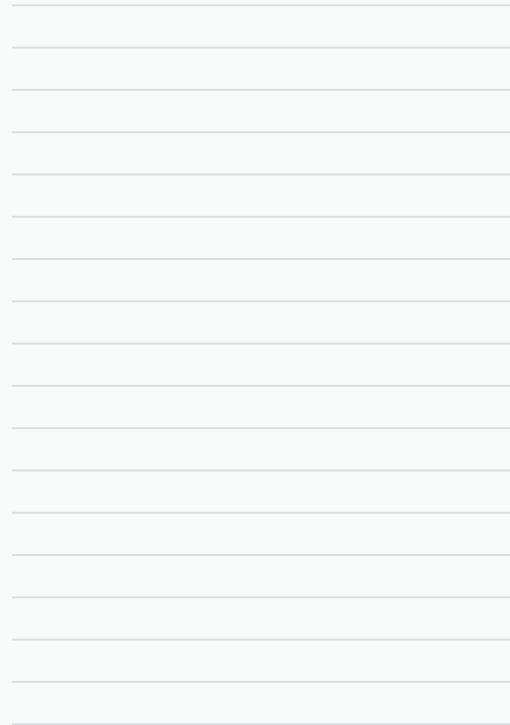

MOT1411A

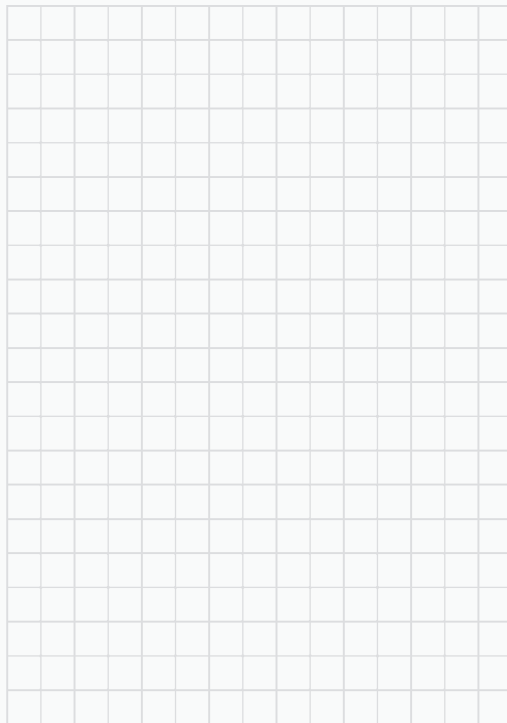

MOT1412A

JOTTER CARD MOTIFS ARE RESERVED FOR DIGITAL PRINTING ONLY. THE WINDOW, GRID AND RULE LINE MOTIFS ARE AVAILABLE FOR JOTTER CARDS ONLY AND WILL BE PRINTED IN A SCREEN IN THE COLOR OF YOUR CHOICE.

* Can Be Embossed

Designs will be printed in the size shown, unless specified otherwise.



Crane

CRANE STATIONERY
461 SARATOGA STREET
COHOES, NY 12047

PHONE (877) 478 4849